

Terrain Drainage Systems

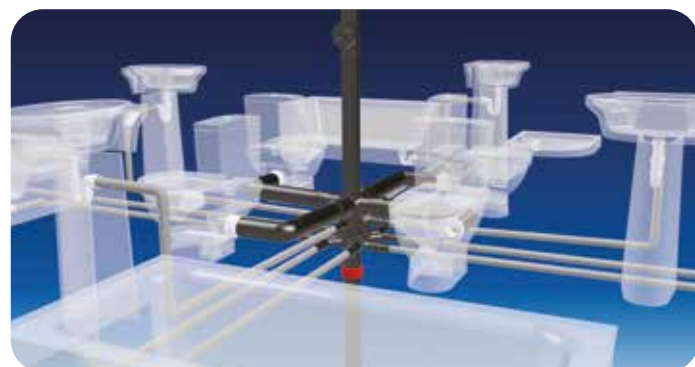

2020 Trade Price List

Terrain Drainage

Welcome to Polypipe

At Polypipe, conceiving, designing, manufacturing and delivering the most advanced products and systems isn't merely an occupation. It's a passion. One that's based around a few simple beliefs. Expertise isn't an option. Quality always beats quantity. Products are nothing without service and support. Sustainability isn't just a 'green' word. And working with our customers is much better than simply supplying them.

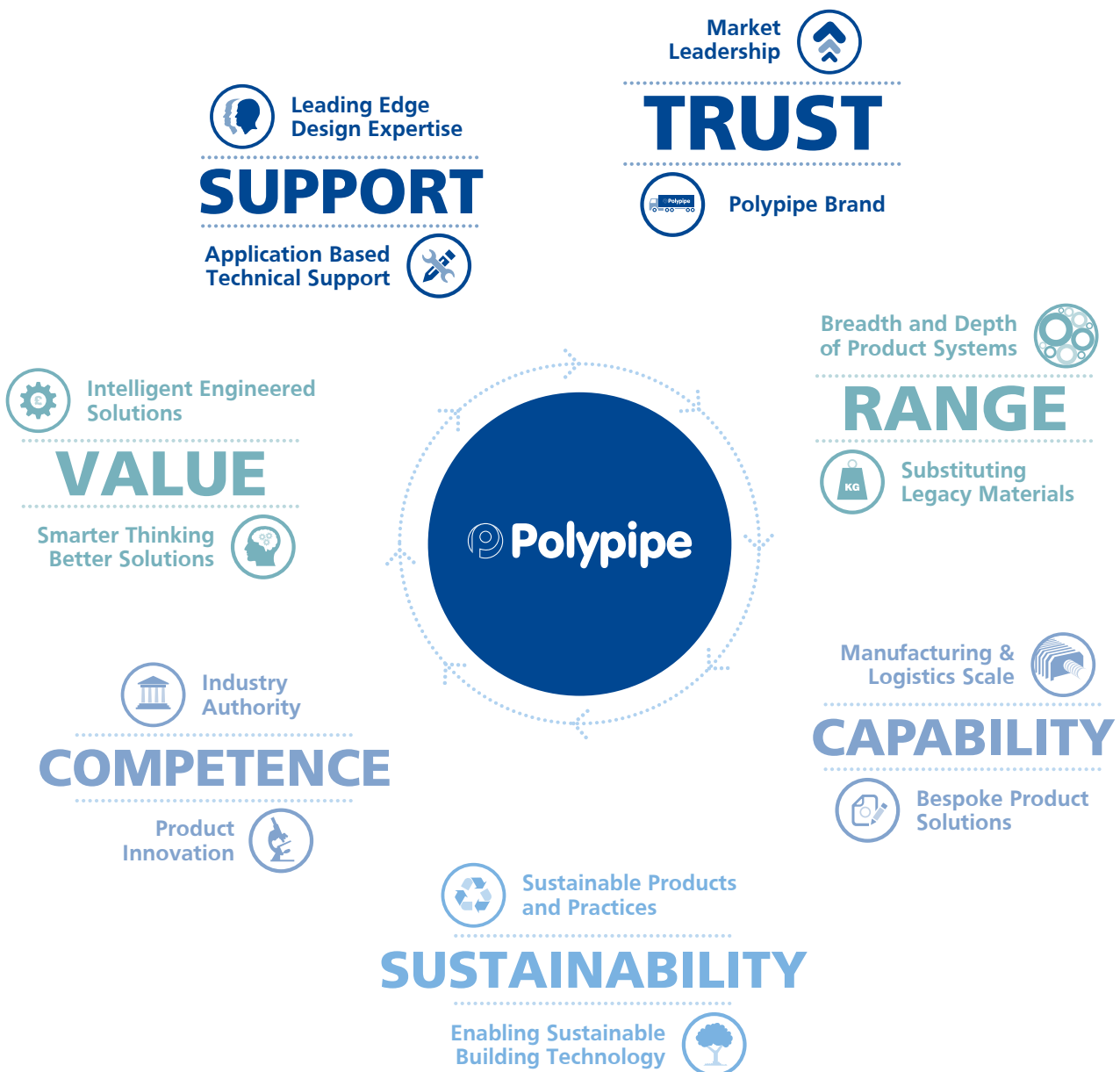



Polypipe has an enviable reputation amongst installers, contractors, stockists and specifiers – and it's not hard to see why. We have over 20,000 product lines, a substantial fleet of over 400 vehicles and well over 3,000 employees.

Our unrivalled portfolio offers dependable, innovative solutions for pressure and non-pressure applications, enabling the movement of water, air, power, chemicals and telecoms throughout the built environment. We operate through sector-focused businesses, ensuring that our Sales and Technical Teams are equipped to meet the specific needs of the residential, civils & infrastructure, commercial and industrial projects.

We are best known for our plastic pipe solutions, but we do so much more. For example, our fabrication service, Polypipe Advantage, is capable of producing bespoke systems that are created to match the site-specific requirements of your project.

Be it a versatile system to manage water, air and energy, or an innovative 'whole building' solution compliant with the latest legislation, our considerable expertise and project knowledge can provide you with almost limitless options. Moreover, our ability to manufacture both on-site and off-site solutions means we can offer savings in terms of project times, Health and Safety considerations and overall costs.

Contents		
Terrain PVC Soil and Waste		5 - 21
Soil Systems:	100 Solvent Weld	6 - 9
	100P Push Fit	9 - 12
Waste Systems:	200 Solvent Weld	12 - 14
	300 PP Push Fit	14
	600 ABS Solvent Waste	15
Overflow:	500 System	16
Traps:	400 System	16 - 17
WC Pan Connectors:	490 System	17 - 18
Soil and Waste Accessories		18 - 19
Terrain Fabrication Service		22
Terrain FUZE		24 - 38
Firetrap Sleeves and Collars		33
Terrain P.A.P.A and Pleura Vent System		39
Terrain dB12		40 - 43
Terrain Siphonic Roof Drainage System		45
Underground		46 - 50
Flexicon Couplers		51
Terrain Standards, Certification and Technical Services		53

A Guide to the Terrain PVC Drainage Numbering System

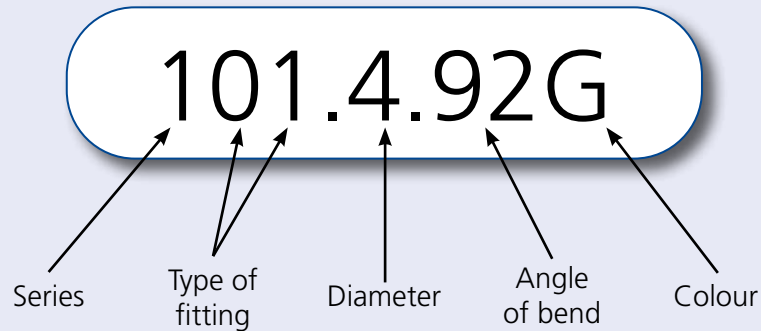

Above Ground Drainage

Series

- 100 = PVCu Solvent Weld Soil
- 100P = PVCu Push Fit Soil
- 200 = MuPVC Solvent Weld Waste
- 300 = PP Push Fit Waste
- 400 = Traps
- 500 = PVCu Overflow
- 600 = ABS Waste
- 900 = FUZE

Diameter

- 1.25 = 1¼" or 32mm N/D waste
- 1.5 = 1½" or 40mm N/D waste
- 2 = 2" or 50mm N/D waste
- 3 = 3" or 82mm O/D soil
- 4 = 4" or 110mm O/D soil
- 6 = 6" or 160mm O/D soil
- 8 = 8" or 200mm O/D soil
- 10 = 10" or 250mm O/D soil

Type of Fitting

- 100 = Pipe
 - 101 = Bend (Double Socket)
 - 104 = Branch
 - 106 = Corner Branches
 - 107 = Bend (Spigot Socket)
 - 110/111 = Couplings
 - 13x = Access Fittings
- (these numbers are the same for all series)

Colour

- G = Grey
- B = Black
- W = White
- R = Rustic (Brown)
- T = Terracotta

Products marked in the product listings are:

 - Available in .DWG file format.

 - Available in .RFA and .ADSK file format.

These files are ready to incorporate into design drawings.

If you would like the files in the relevant format, simply contact the Advantage Team on 01622 795200 or email commercialeenquiries@polypipe.com.

Terrain Soil & Waste



Introduction

Having pioneered the development of solvent-welded systems, Terrain soil and waste products represent the industry benchmark for quality, installation flexibility and product innovation backed by the highest levels of customer service.

Terrain drainage systems include an extensive range of soil and waste drainage products for high rise residential, hotels, hospitals, schools and public sector developments, all built on the strength of the Terrain brand.

Systems include solvent-welded and push-fit options for both soil and waste drainage; overflow and trap systems; and a comprehensive range of adaptors and accessories. Products are available in a range of colours.

- Industry leading range of solvent and push-fit soil and waste solutions.
- Unique products offer unrivalled installation options.
- Adaptable to our Terrain FUZE system.
- Includes a number of unique UK fittings making it versatile for a number of applications.

100-Solvent Terrain Soil System

82, 110 and 160mm PVCu soil pipes and fittings

- Wide range of bends, branches and access fittings to meet all application requirements
- Great problem solving products in the range

100P-PushFit Terrain Soil System

82, 110, 160, 200 and 250mm PVCu soil pipes and fittings for push-fit jointing

- Saves time and labour costs
- Also for use with Terrain roof outlets for rainwater drainage



200-Solvent Terrain Waste System

Solvent-welded MuPVC system

- 32, 40 and 50mm integrated systems
- Wide range of bends and adaptors
- Integrated floor gullies

300-PushFit Terrain Waste System

Push-fit polypropylene system

- 32 and 40mm integrated systems
- Quick and easy to install
- Saves time and labour costs

400-Traps Terrain Traps

Polypropylene traps

- 32 and 40mm polypropylene traps
- Range includes self resealing bottle traps
- All traps have universal compression outlets which, in addition to all Terrain waste pipes, will accept other MuPVC waste pipe

500-Overflow Terrain Overflow System

Solvent-welded PVCu system for cold, non-pressure water

- 19mm PVCu pipe and fittings
- Range of tank connectors

600-Solvent Terrain Waste System

Solvent-welded ABS system

- 32, 40 and 50mm integrated systems
- Wide range of bends and adaptors

Terrain

Soil Systems - 100 Solvent



Size mm	Angle	Col	Pack/Box	Code	Price Each	
Soil pipe						
Plain ended.						
82 (3m)		GW	2/88	100.3.30	£73.43	
82 (4m)		GW	2/88	100.3.40	£96.15	
110 (3m)		GBW	2/48	100.4.30	£71.43	
110 (4m)		GBW	2/48	100.4.40	£95.19	
160 (3m)		G	1/33	100.6.30	£194.57	
160 (4m)		G	1/33	100.6.40	£254.31	
For larger diameter pipes, please see page 12.						
Ring seal adaptor						
Converts Terrain solvent socket to a ring seal expansion socket.						
82		G	10/120	109.3	£8.47	
110		GBW	10/80	109.4	£7.90	
160		G	5/60	109.6	£22.34	
Straight coupler double socket						
Double solvent socket.						
82		GW	5/85	110.3	£13.06	
110		GBW	5/60	110.4	£15.89	
160		G	10	110.6	£47.12	
Expansion coupler						
To allow expansion in longer pipe runs.						
82		GW	5/65	111.3	£19.97	
110		GBW	10	111.4	£19.40	
160		G	3	111.6	£61.48	
Slip coupler						
Double ring seal socket. No central stop.						
82		G	5/30	111.5.3	£41.48	
110		GB	5/15	111.5.4	£34.89	
160		G	5	111.5.6	£75.39	
Swept bend double socket						
(82mm) 92½° and 135° as standard. (110mm) 92½°, 104°, 112½° and 135° as standard.						
82	92½°		GW	5/40	101.3.92	£32.82
110	92½°		GBW	10	101.4.92	£37.31
Radius 104mm						
160	92½°		G	2	101.6.92	£97.74
110	104°		G	5/20	101.4.104	£38.85
110	112½°		GB	5/20	101.4.112	£38.85
82	135°		GBW	5/50	101.3.135	£32.82
110	135°		GBW	5/30	101.4.135	£37.31
160	135°		G	4	101.6.135	£95.60
Spigot socket bends						
Long tail.						
82	92½°		G	5/40	107.3.92	£32.42
110	92½°		GBW	10	107.4.92	£36.16
110	135°		GBW	15	107.4.135	£40.58

Prices shown are for one item excluding VAT

Soil Systems - 100 Solvent

























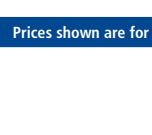









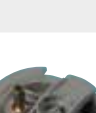

Size mm	Angle	Col	Pack/Box	Code	Price Each	
Variable bend spigot/socket						
Adjustable 0-25°.						
110	0-25°		G	5/25	107.4.025	£71.62
Double spigot.						
110	0-25°		G	5/20	101.4.025	£71.35
Swept entry equal branch						
With boss connections.						
104.3.92				2 boss horns		
104.4.92				3 boss horns		
104.4.924				4 boss horns		
104.6.92				5 boss horns		
104.4.104				2 boss horns		
Connect to boss horns using 117 boss adaptors see page 11.						
82	92½°		GW	5/25	104.3.92	£45.84
82	135°		G	5/25	104.3.135	£45.84
110	92½°		GBW	7	104.4.92	£49.36
110	92½°		GBW	5	104.4.924	£61.21
110	104°		G	5/10	104.4.104	£62.36
160	92½°		G	4	104.6.92	£110.19
Single equal branch						
No boss connections. Solvent weld all sockets.						
110	135°		GBW	6	104.4.135	£51.49
160	135°		G	3/54	104.6.135	£210.30
160	135°		G	5	104AS.6.135	£70.09
Single branch spigot outlet						
With boss connections. 4 boss horns.						
110	92½°		GB	4	104.104.92	£64.34
Single equal branch variable boss						
2 boss horns 2 waste sockets.						
Spigot outlet						
110	92½°		G	4	104.412.92	£113.87
Socket outlet						
110	92½°		G	3	104.422.92	£116.01
Single unequal branch triple socket						
2 boss horns.						
160/110	92½°		G	3	104.64.92	£124.40
No waste boss connections.						
160/110	135°		G	2	104.64.135	£130.82

Prices shown are for one item excluding VAT

Colours: G - Grey B - Black W - White T - Terracotta

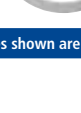
Soil & Waste

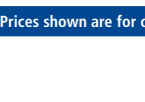
Soil Systems - 100 Solvent							
	Size mm	Angle	Col	Pack/Box	Code	Price Each	
Corner branch all socket							
	110	92½	G	5	106.490.92	£220.17	
Corner boss branch							
	110	92½	G	7	106.490.12	£255.18	
	110	92½	G	3	106.490.22	£255.18	
Double branch							
	110	92½	G	2	106.104.92	£124.68	
	110	92½	GW	2	106.4.92	£106.65	
	110	135	G	6	106.4.135	£130.30	
	82	92	G	10	106.3.92	£47.98	
	160	135	G	1	106.6.135	£79.16	
Double unequal branch							
	160/110	92½	G	2	106.64.92	£231.75	
Access pipe double socket							
	110		GBW	10	138.4	£39.22	
Access pipe spigot outlet							
	110		GB	10	139.4	£40.20	
	160		G	10	139.6*	£62.91	
Access pipe connector							
	82		GW	5/25	137.3	£82.04	
	110		GBW	5/15	137.4	£50.41	

Soil Systems - 100 Solvent							
	Size mm	Angle	Col	Pack/Box	Code	Price Each	
Access bend double socket							
	110	92½	GBW	5/15	103.4.92	£103.51	
Single access branch triple socket							
	110	92½	G	6	105.4.92	£86.37	
	160	135	G		5105.6.135	£81.14	
Pipe access door							
	82		G	5	135.3	£45.45	
	110		GB	5/45	135.4	£43.36	
	160		G	5/50	135.6	£79.75	
Access cap							
	82		GW	5/70	136.3	£30.91	
	110		GBW	5/30	136.4	£35.41	
	160		G	5/35	136.6	£70.09	
Access door with test nipple							
	110		G	50	6592/DVW*	£54.62	
*Fabricated item							
Thermal movement limiter							
	82		Self	20	190.3	£65.85	
	110		Self	5/15	190.4	£69.62	
	160		Self	5	190.6	£113.57	
Intermediate support bracket							
	82		Self	30	191.3	£33.52	
	110		Self	20	191.4	£35.40	
	160		Self	10	191.6	£48.74	
Two piece pipe bracket							
	82		Self	10/40	140.3	£10.62	
	110		Self	10/30	140.4	£10.73	
	160		Self	5/25	140.6	£26.54	









Prices shown are for one item excluding VAT

Prices shown are for one item excluding VAT

Colours: G - Grey B - Black W - White T - Terracotta

Soil Systems - 100 Solvent









	Size mm	Angle	Col	Pack/Box	Code	Price Each
One piece pipe bracket						
	82	▽□	GBW	10/150	143.3	£7.58
	110	▽□	GBW	10/80	143.4	£6.90
Adjustable pipe bracket plastic coated						
Both have self coloured backplates.						
	110	▽□	BW	1/30	144.4	£14.31
Weathering apron						
Makes weathertight cover between soil pipe and lead slate at roof level.						
For lead slates.						
	82	□	GB	60	131.3	£9.61
	110	□	GBW	5/90	131.4	£10.55
	160	□	G	5/15	131.6	£33.24
For asphalt upstand.						
	82	▣	G	5/40	131.3.200	£40.62
	110	▣	G	30	131.4.200	£38.77
Weathering slates						
Makes watertight seal around pipe at roof level. Available for flat or pitched roof.						
Colours: Base - Aluminium. Cone - Black						
For flat roof						
	82 to 110	□▣	Alu/B	20	149.16.00	£111.89
	For sloping roof (min 30°)					
82 to 110	▣	Alu/B	20	149.18.22	£114.71	
For sloping roof (min 17°)						
82 to 110	□▣	Alu/B	10	149.24.22	£155.03	
Vent Cowl						
	82	□	G	5/120	150.3	£9.47
	110	□	GBW	5/180	150.4	£9.08
	160	□	G	5/65	150.6	£25.46
Duct cowl						
Stops rainwater from entering ventilation ducts.						
	110	□	GB	5/25	152.4	£41.59
	160		G	12	152.6	£107.82
Automatic air admittance valve						
Allows air to enter soil system, protecting water seals in traps from effects of negative pressure.						
	82	▽□	W	1/18	153.3	£108.79
	110	▽□	W	1/18	153.4	£108.79

Prices shown are for one item excluding VAT

Soil Systems - 100 Solvent



	Size mm	Angle	Col	Pack/Box	Code	Price Each
Two part waste boss solvent socket						
For 32mm waste pipe.						
	110/32	▣	G	5/200	112.4.125	£17.82
	For 40mm waste pipe					
82/40	▣	G	5/150	112.3.15	£18.34	
110/40		G	5/150	112.4.15	£17.82	
For 50mm waste pipe						
110/50	▣	G	5/100	112.4.2	£18.09	
160/50	□▣	G	5	112.6.2	£25.93	
Socket plug						
With boss horn.						
	110		G	5/50	130.4	£22.41
	160		G	5/35	130.6	£43.11
Self locking boss seal ring socket						
Installation guide is in the technical manual.						
For 32mm waste pipe.						
	110/32	▽□▣	G	10/130	122.4.125	£24.25
	For 40mm waste pipe					
110/40	▽□▣	GB	10/100	122.4.15	£25.33	
Single bossed pipe connector double socket						
For 32mm waste pipe.						
	110/32	▽□▣	GBW	5/30	120.4.125	£13.35
	For 40mm waste pipe.					
110/40	▽□▣	GBW	5/30	120.4.15	£13.35	
For 50mm waste pipe*.						
110/50	▽□	GBW	5/30	123.4	£14.08	
*Requires a boss adaptor						
Single bossed pipe connector spigot						
For 40mm waste pipe.						
	110/40	▽□▣	G	5/30	120.412.15	£13.22
Double bossed pipe connector double socket						
2 50mm waste sockets. 2 blanking plugs.						
For 50mm waste pipes (40mm with adaptor).						
	82/50	▽□▣	G	5/30	120.3.2	£28.15
Triple bossed pipe connector double socket						
For 40mm waste pipe. 1 blank plug.						
	110/40	▽□▣	GB	5/25	121.4.15	£22.12

Prices shown are for one item excluding VAT

Colours: G - Grey B - Black W - White T - Terracotta

Soil & Waste

Soil Systems - 100 Solvent						
Size mm	Angle	Col	Pack/Box	Code	Price Each	
Four way boss double socket						
2 boss horns, 2 waste sockets.						
110	▽R	GB	9	120.4.2	£21.69	
160	▽	G	4	120.6.2	£70.81	
Four way boss pipe solvent socket/spigot						
2 boss horns, 2 waste sockets.						
110	R	G	5/15	120.412.2	£22.12	
Universal soil manifold						
For Solvent waste connections						
For connection of BS 5255 40mm waste pipes at floor level. Incorporates 4 inlets to accept 40mm waste pipes without need for adaptors. Use with Swivel Elbow or Swept Bend.						
For push fit version see page 13						
110	R	G	5	119.412.15	£68.18	
Socket reducer socket/spigot						
82/50	▽R	GW	5/90	124.3.2	£19.87	
110/50	▽R	GBW	5/60	124.4.2	£24.08	
110/82	▽R	GBW	5/60	124.4.3	£24.82	
160/110	▽R	G	5/45	124.6.4	£52.89	
Straight boss adaptor ring seal socket						
For 32mm waste pipe. Use on 82, 110 & 160mm stacks.						
82, 110, 160	▽	GBW	10/180	117.125	£6.98	
For 40mm waste pipe. Use on 82, 110 & 160mm stacks.						
82, 110, 160	▽	GBW	5/160	117.15	£6.98	
For 50mm waste pipe. Use on 82, 110 & 160mm stacks.						
82, 110, 160	▽	GBW	5	117.2	£9.94	
Requires seal 9132, found on page 22.						
Boss adaptor bend solvent socket						
For 40mm waste pipe. Use on 82, 110 & 160mm stacks						
82, 110, 160	▽R	GW	10/130	117.15.90	£10.41	
For 50mm waste pipe. Use on 82, 110 & 160mm stacks						
82, 110, 160	▽R	GW	10/190	117.2.90	£12.48	
82, 110, 160	▽R	G	10/120	117.2.150	£11.33	
Adaptor to underground drain						
Push fit into bore of underground pipe.						
82/110		B	5/50	4DW3	£32.64	
Adaptor to cast iron spigot						
82	R	G	5/30	126.3.12	£24.18	
110	R	G	5/15	126.4.12	£31.52	
Requires seal 9119.B found on page 19.						

Prices shown are for one item excluding VAT

Soil Systems - 100 Solvent						
Size mm	Angle	Col	Pack/Box	Code	Price Each	
Adaptor saddles						
Used with 117 Waste Adaptors to enable direct connection of 32mm, 40mm and 50mm waste pipe to soil pipe.						
110/40		G	5	115P.4	£14.95	
PVCu caulking bush						
To connect soil pipe to sockets of other material.						
110	▽	G	5/15	132.4	£31.06	

Prices shown are for one item excluding VAT

Soil Systems - 100P Pushfit						
Size mm	Angle	Col	Pack/Box	Code	Price Each	
Soil pipe single socket ended						
82 (3m)	▽	G	1/88	100P.3.30	£64.98	
82 (4m)	▽	G	1/88	100P.3.40	£88.05	
110 (3m)	▽	GB	2/67	100P.4.30	£64.17	
110 (4m)	▽	G	2/67	100P.4.40	£86.19	
160 (3m)	▽	G	1/33	100P.6.30	£179.19	
160 (4m)	▽	G	1/33	100P.6.40	£239.01	
Soil pipe plain ended						
200 (4m)		G	1	100.8.40	£303.82	
250 (4m)		G	1	100.10.40	£434.64	
Slip coupler double socket						
110	R	G	5/40	111.SP4	£27.65	
Straight coupler double socket						
With central stop.						
82	▽R	G	10/30	110P.3	£26.19	
110	▽R	GB	5/40	110P.4	£22.20	
160	▽R	G	5	110P.6	£55.19	
200	R	G	68	110P.8	£62.14	
250	R	G	2	110P.10	£97.20	
Pipe end socket spigot/socket						
82	▽R	G	10/60	111P.3	£14.58	
110	▽R	GB	20	111P.4	£15.52	
160	▽R	G	5/15	111P.6	£50.84	

Prices shown are for one item excluding VAT

Soil Systems - 100P Pushfit



	Size mm	Angle	Col	Pack/Box	Code	Price Each	
Swept bend spigot/socket							
	82	92½	♠	G	5/25	101P.3.92	£32.56
	110	92½	♠	GB	10	101P.4.92	£33.35
	160	92½	♠	G	4	101P.6.92	£107.19
	200	92½	♠	G	1/3	101P.8.92	£182.52
	110	112½	♠	G	10	101P.4.112	£38.79
	82	135	♠	G	5/40	107P.3.135	£28.63
	110	135	♠	GB	15	107P.4.135	£33.67
	160	135	♠	G	8	107P.6.135	£101.51
	200	135	♠	G	50	107P.8.135	£124.68
	250		♠	G	2	107P.10.135	£165.97
Tight radius bend spigot/socket							
	110	92½	♠	G	10	107P.4.92	£34.41
2 Part variable bend							
	110	20-87½	♠	G	1/8	107P.4.VAR	£65.50
Double socket bend							
	110	92½	♠	G	5/15	101D.4.92	£41.04
Single branch spigot outlet							
	With boss connections. 2 boss horns.						
	82	92½	♠	G	5/15	104P.3.92	£52.08
	5 boss horns.						
	110	92½	♠	GB	8	104P.4.92	£44.98
	160	92½	♠	G	4	104P.6.92	£124.19
	110	112½		G	5	104P.4.112	£66.14
Single unequal branch spigot outlet							
	5 boss horns.						
	160/110	87½	♠	G	5	104P.64.92	£122.21
	No boss horns.						
	160/110	45	♠	G	4	104P.64.135	£122.21
	200/110	135	♠	G	2	104P.84.135	£155.92
	200/160	135	♠	G	2	104P.86.135	£236.60
	250/160	135	♠	G	6	104P.106.135	£230.62
	250/200	135	♠	G		104P.108.135	£237.04

Prices shown are for one item excluding VAT

Soil Systems - 100P Pushfit



	Size mm	Angle	Col	Pack/Box	Code	Price Each	
Single equal branch plain							
No boss connections.							
	200	92½		G	1/2	104P.8.92	£261.18
	82	135	♠	G	4/20	104P.3.135	£84.90
	110	135	♠	G	6	104P.4.135	£47.30
	160	135	♠	G	4	104P.6.135	£97.14
	200	135	♠	G	20	104P.8.135	£114.78
	250	135	♠	G	8	104P.10.135	£298.02
Corner boss branch							
	110	92½		G	1/6	106E.490.12	£244.76
Corner branch spigot outlet							
	110	92½		G	2	106P.490.92	£111.11
Single branch socket outlet							
No boss connections.							
	110	135		G	12	104E.4.135	£52.22
Branch socket outlet							
3 boss horns.							
	110	92½		G	9	104E.4.92	£52.02
Single equal branch variable boss							
3 boss horns. 2 50mm waste sockets with blanking plugs. For 50mm waste pipes (40mm with adaptor).							
	110	92½		G	4	104E.412.92	£116.66
Adjustable bend spigot outlet							
	110			G	5/25	107P.4.025	£73.29









Prices shown are for one item excluding VAT

Colours: G - Grey B - Black W - White T - Terracotta

Soil & Waste

Soil Systems - 100P Pushfit							
Size mm	Angle	Col	Pack/Box	Code	Price Each		
Double equal branch spigot outlet							
4 boss connections.							
	110	92½	R	G	2	106P.4.92	£122.55
Access pipe and cover single socket							
	82		▽	GB	10	139P.3	£65.24
	110		▽	GB	10	139P.4	£60.93
Access door aperture size: 172 x 130mm diameter – secured by 2 screws.							
	160		▽	G	1/5	139P.6	£134.25
	200			G		139P.8	£90.52
	250			G	16	139P.10	£336.24
Access bend single socket							
Access door aperture size: 110 x 80mm diameter – secured by locking mechanism (use self tapping screw for anti-vandal locking).							
	82	92½		G	12	103P.3.92	£128.22
	160	92½		G	6	103P.6.92	£247.99
Access single equal branch single outlet							
With waste boss connections. 4 boss horns. Access door aperture size: 114 x 80mm diameter – secured by locking mechanism (use self tapping screw for anti-vandal locking).							
	82	92½		G	10	105P.3.92	£117.50
	110	92½	▽R	G	4	105P.4.92	£109.81
Access single equal branch single outlet							
	160	135	▽	G		105P.6.135	£214.78
Access door with test nipple							
Standard oval access door with test nipple for manometer connection.							
	127			G	50	6592/DVW*	£54.62
*Fabricated item							

Prices shown are for one item excluding VAT

Soil Systems - 100P Pushfit							
Size mm	Angle	Col	Pack/Box	Code	Price Each		
Access Cap							
	82		▽ R	GB	5/40	136P.3	£26.56
	110		R	GB	5/40	136P.4	£29.88
	160		R	G	15	136P.6	£73.65
Strap-on boss							
For 32mm waste pipe.							
	110/32		R	GB	10/100	112P.4.125	£15.15
For 40mm waste pipe.							
	110/40		R	GB	10/90	112P.4.15	£15.15
For 50mm waste pipe.							
	110/50		R	GB	10/80	112P.4.2	£15.32
Straight boss adaptors							
For 32mm waste pipe. Use on 82, 110 & 160mm stacks.							
	82, 110, 160		▽	GBW	10/180	117.125	£6.98
For 40mm waste pipe. Use on 82, 110 & 160mm stacks.							
	82, 110, 160		▽	GBW	5/160	117.15	£6.98
For 50mm waste pipe. Use on 82, 110 & 160mm stacks.							
	82, 110, 160		▽	GBW	5	117.2	£9.94
Adaptor saddles							
Used with 117 Waste Adaptors to enable direct connection of 32mm, 40mm and 50mm waste pipe to soil pipe.							
	110/40			G	5	115P.4	£14.95
Reducers							
	82/50		▽ R	G	5/85	124P.3.2	£24.47
	110/50		R	G	5/60	124P.4.2	£32.49
	110/82		R	G	5/30	124P.4.3	£32.49
	160/110		▽ R	G	5/15	124P.6.4	£49.06
	200/110		R	G	12	124P.8.4	£50.73
	200/160		R	G	96	124P.8.6	£51.73
	250/110		R	G		124P.10.4	£57.33
	250/160		R	G	85	124P.10.6	£65.28
	250/200		R	G	6	124P.10.8	£70.89
Short bossed pipe							
With boss connection.							
	82		▽ R	G	5/15	123P.3	£19.30
	110		R	GB	10	123P.4	£18.61
Three way bossed pipe							
1 boss horn, 2 x 40mm waste bosses.							
	82			G	5	123P.312	£39.86

Prices shown are for one item excluding VAT

Colours: G - Grey B - Black W - White T - Terracotta

Soil Systems - 100P Pushfit



Size mm	Angle	Col	Pack/Box	Code	Price Each
Four way boss pipe pushfit socket/spigot					
2 boss horns. 2 waste sockets.					
110	▽	G	5/15	120P.412.2	£23.98
160		G	4	120P.612.2	£78.30
Triple boss collar					
2 boss horns. 1 waste socket.					
110/40	▽	GB	10/30	120P.4.15	£18.61
Socket Plug					
With boss horn.					
110	▽	G	5/50	130.4	£22.41
160	▽	G	5/35	130.6	£43.11
Universal soil manifold					
For Pushfit waste connections. For connection of BS 5254/BS 5255 32mm and 40mm waste pipes at floor level.					
Incorporates 4 inlets to accept 32mm or 40mm waste pipes without need for adaptors. Use with Swivel Elbow or Swept Bend. Complete with 4 sealing gaskets, and 3 removable plugs.					
For solvent version see page 11					
110		G	5	119P.4.15	£69.20

Prices shown are for one item excluding VAT

Waste Systems - 200 Solvent



Size mm	Angle	Col	Pack/Box	Code	Price Each
Waste pipe					
Plain ended.					
32 (3m)	▽	GW	5	200.125.30	£15.57
32 (4m)	▽	GBW	5	200.125.40	£20.74
40 (3m)	▽	GW	5	200.15.30	£19.24
40 (4m)	▽	GBW	5	200.15.40	£25.66
50 (3m)	▽	GW	5	200.2.30	£29.58
50 (4m)	▽	GBW	5	200.2.40	£38.69
Seal ring adaptor					
To convert 50mm 207.2 spigot socket bends to expansion fitting.					
50		GW	5/250	209.2	£7.94
Straight coupler double socket					
32	▽	GBW	10/350	210.125	£3.32
40	▽	GBW	10/240	210.15	£3.30
50	▽	GBW	10/120	210.2	£6.03
Union double socket					
Threaded union for easy disconnection if required.					
32	▽	G	5/200	211.125	£14.20
40	▽	G	5/125	211.15	£18.57
50	▽	G	5/90	211.2	£21.16

Prices shown are for one item excluding VAT

Waste Systems - 200 Solvent



Size mm	Angle	Col	Pack/Box	Code	Price Each	
Expansion coupler seal ring and solvent socket						
32	▽	GW	10/240	225.125	£5.84	
40	▽	GW	10/180	225.15	£7.21	
50	▽	GW	5/100	225.2	£9.55	
Spigot/socket coupler						
To create a close-coupled expansion joint for all MuPVC fittings.						
32	▽	GW	5/250	227.125	£5.97	
40	▽	GW	5/180	227.15	£7.32	
50	▽	G	5/100	227.2	£9.74	
Swept bend double socket						
91¼°, 135° and 165° as standard. For 91¼° swept bend.						
32	91¼	▽	GBW	20/220	201.125.91	£3.38
40	91¼	▽	GBW	10/140	201.15.91	£3.73
50	91¼	▽	GBW	10/70	201.2.91	£6.61
For 135° swept bend						
32	135	▽	GBW	10/280	201.125.135	£3.38
40	135	▽	GBW	10/200	201.15.135	£3.73
50	135	▽	GBW	10/100	201.2.135	£6.61
For 165° swept bend						
32	165	▽	G	10/320	201.125.165	£5.23
40	165	▽	G	5/200	201.15.165	£6.76
50	165	▽	G	5/250	201.2.165	£8.90
Spigot/socket bends						
To change pipe direction in limited-space situations: 92½° and 150° as standard.						
32	92½	▽	GBW	10/160	207.125.92	£5.53
40	92½	▽	GBW	10/100	207.15.92	£6.32
50	92½	▽	GW	5/50	207.2.92	£9.02
32	135	▽	GBW	10/300	207.125.135	£5.61
40	135	▽	GBW	10/180	207.15.135	£6.57
50	135	▽	GW	5/100	207.2.135	£9.18
32	150	▽	G	10/260	207.125.150	£5.84
40	150	▽	G	5/200	207.15.150	£6.68
Knuckle bend double socket						
32	91¼	▽	GBW	10/280	202.125.91	£3.07
40	91¼	▽	GBW	10/180	202.15.91	£3.39
Swept cross all socket						
40	91¼	▽	GW	5/105	206.15.91	£14.25
50	91¼	▽	GW	5/55	206.2.91	£14.91
50	135	▽	G	5/55	206.2.135*	£99.45
*Fabricated						



Prices shown are for one item excluding VAT

Colours: G - Grey B - Black W - White T - Terracotta

Soil & Waste

Waste Systems - 200 Solvent						
Size mm	Angle	Col	Pack/Box	Code	Price Each	
Swept tee all socket						
91¼° and 135° as standard.						
	32	91¼	GW	10/120	204.125.91	£4.53
	40	91¼	GW	10/90	204.15.91	£5.73
	50	91¼	GW	5/45	204.2.91	£11.18
	32	135	GW	10/120	204.125.135	£5.54
	40	135	GW	5/80	204.15.135	£7.19
	50	135	GW	5/80	204.2.135	£11.18
Level invert taper						
To reduce socket of any standard fitting to accept a smaller size pipe. Larger end spigot and smaller end socket.						
	40/32		GW	5/230	223.15.125	£4.25
	50/32		GW	10/190	223.2.125	£5.25
	50/40		GW	10/160	223.2.15	£5.14
Socket reducer						
	40/32		GBW	20/640	224.15.125	£3.32
	50/32		GBW	10/350	224.2.125	£4.79
	50/40		GBW	10/350	224.2.15	£5.86
Pipe fixing clip						
	32		GBW	20/800	240.125	£1.09
	40		GBW	20/700	240.15	£1.25
	50		GBW	20/400	240.2	£1.66
Expansion fitting fixing clip						
To secure control thermal expansion at regular points along pipework.						
	32		W	10/750	242.125	£1.34
	40		W	10/500	242.15	£1.52
	50		GW	10/300	242.2	£3.22
Access plug						
	32		GBW	10/350	237.125	£3.07
	40		GBW	10/320	237.15	£3.07
	50		GBW	10/170	237.2	£4.41
Weathering apron						
To provide weathertight cover over lead slate around 50mm waste pipe penetrating roof.						
	50		G	5/135	231.2	£7.30
Vent cowl						
	50		GW	5/300	250.2	£8.28

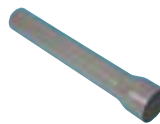
Prices shown are for one item excluding VAT

Waste Systems - 200 Solvent						
Size mm	Angle	Col	Pack/Box	Code	Price Each	
Automatic air admittance valve						
Allows air into waste system when negative pressure occurs. Helps prevent syphonage of traps.						
	50		W	10/200	253.2	£42.30
Trapped floor gully						
Under-floor trap (e.g. for shower areas) with 3 sockets to accept 40mm waste pipe. Seal depth: 50mm. Cleaning access via removable baffle with integral gasket to maintain airtight seal.						
	110/82		G	20	281.43	£44.05
	160/110		GT	12	281.64	£45.04
Floor gully inlets						
Two-part fitting to be set in standard-tiled floor (e.g. in shower areas). Comprises of raising piece with 150mm square top, and snap-in cover.						
	110 PVC		GW	36	282.6	£15.99
	110 SS		Self	36	283.6	£33.72
Sealed gully raising piece and stainless steel cover						
Two-part fitting to be set in standard-tiled floor (e.g. in shower areas). Comprises of raising piece with 150mm square top, and screw in cover.						
	110 PVC		GW	36	284.6	£20.38
	110 SS		Self	36	285.6	£34.47
Adaptor to underground drain pipe						
Push-fit connection into pipes with nominal 100mm bore. External use only.						
	32/40/50		B	5/60	4DW200	£31.93
Adaptor to metal pipe						
Supplied with seal ring.						
	50		G	5/55	226.2	£18.92
Caulking bush						
For connecting MuPVC waste pipe to 50mm socket of other material. Solvent-weld to pipe.						
	32/40/50		G	10/350	232	£8.25
Reverse nut adaptor						
For solvent-weld connection of MuPVC waste pipe (or waste fitting) to BSP male threaded fitting or pipe.						
	32/32		W	10/300	218.125	£7.85
	40/40		W	10/250	218.15	£7.71

Prices shown are for one item excluding VAT

Colours: G - Grey B - Black W - White T - Terracotta

Waste Systems - 200 Solvent



Size mm	Angle	Col	Pack/Box	Code	Price Each
200 waste female iron					
For solvent-weld connection of MuPVC waste pipe or fitting to BSP threaded male pipe or fitting.					
Socket and threaded socket					
32/32		G	10/270	212.125	£6.03
40/40		G	10/200	212.15	£6.03
50/50		G	5/140	212.2	£8.69
Spigot and threaded socket					
32/32		G	5/225	216.125	£5.80
40/40		G	5/190	216.15	£6.82
50/50		G	5/200	216.2	£9.91
200 waste male iron					
For solvent-weld connection of MuPVC waste pipe or fitting to BSP threaded female pipe or fitting.					
Socket and threaded spigot.					
32/32		GW	10/320	213.125	£5.15
40/40		GW	10/240	213.15	£6.03
50/50		GW	5/140	213.2	£8.69
Spigot and threaded spigot.					
32/32		G	5/300	217.125	£5.80
40/40		G	5/240	217.15	£6.82
50/50		GW	5/160	217.2	£9.33

Prices shown are for one item excluding VAT

Waste Systems - 300 Pushfit



Size mm	Angle	Col	Pack/Box	Code	Price Each
Waste pipe					
Plain-ended.					
32 (3m)		W	10	300.125.30	£8.52
40 (3m)		W	10	300.15.30	£10.57
Straight coupler double socket					
32		W	10/350	310.125	£2.84
40		W	10/300	310.15	£2.78
Swept bend double socket					
91¼° and 135° as standard. For 91¼° swept bend.					
32	91¼°	W	10/240	301.125.91	£2.78
40	91¼°	W	10/200	301.15.91	£2.84
Swept bend double socket					
For 135° swept bend.					
32	135°	W	10/300	301.125.135	£2.84
40	135°	W	10/280	301.15.135	£2.78

Prices shown are for one item excluding VAT

Waste Systems - 300 Pushfit









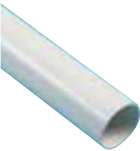

Size mm	Angle	Col	Pack/Box	Code	Price Each
Knuckle bend double socket					
32	90°	W	10/160	302.125.90	£2.78
40	90°	W	10/220	302.15.90	£2.78
Swivel elbow bend socket/spigot					
32	90°	W	10/170	307.125.90	£2.84
40	90°	W	10/110	307.15.90	£2.84
Swept tee					
32	91¼°	W	10/160	304.125.91	£3.11
40	91¼°	W	5/120	304.15.91	£3.11
Socket reducer					
To reduce waste socket to accept smaller diameter waste pipe.					
40/32		W	10/400	323.15.125	£3.04
Pipe and fitting clip					
32		W	20/800	340.125	£0.96
40		W	20/600	340.15	£0.96
Access plug					
32		W	10/500	337.125	£2.84
40		W	10/500	337.15	£2.84
Tank connector					
For connecting push-fit polypropylene pipe to water tank. Supplied with 2 sealing washers.					
32		W	10/150	311.125	£2.84
40		W	10/300	311.15	£2.84
Compression reducer					
40-38					
32mm seal for PS38					
40mm seal for PS38					
W 100 PS38					
PRD100					
PRD101					
£3.73					
£0.91					
£0.91					







Prices shown are for one item excluding VAT

Colours: G - Grey B - Black W - White T - Terracotta SS - Stainless Steel

Soil & Waste

Waste Systems - 600 ABS Solvent						
	Size mm	Angle	Col	Pack/Box	Code	Price Each
Waste pipe						
	Plain ended.					
	32 (3m)			5	600.125.30	£14.15
	40 (3m)			5	600.15.30	£18.86
	50 (3m)			5	600.2.30	£20.74
Straight coupler double socket						
	32			10	610.125	£3.02
	40			10	610.15	£2.99
	50			10	610.2	£5.48
Swept bend double socket						
	For 91¼° swept bend, 91.25°, 135° and 165° as standard.					
	32	91¼	W	20/220	601.125.91	£3.07
	40	91¼	W	10/140	601.15.91	£3.39
	50	91¼	W	10/70	601.2.91	£6.00
Knuckle bend double socket						
	32	91¼	W	10/280	602.125.91	£2.80
	40	91¼	W	10/180	602.15.91	£3.09
Swept bend double socket						
	For 135° swept bend.					
	32	135	W	10/280	601.125.135	£3.07
	40	135	W	10/200	601.15.135	£3.39
	50	135	W	10/100	601.2.135	£6.00
Spigot/socket bends						
	To change pipe direction in limited space situations.					
	32	135	W	10/300	607.125.135	£5.12
	40	135	W	10/180	607.15.135	£5.97
Expansion coupler seal ring and solvent socket						
	32		W	10/250	625.125	£5.31
	40		W	10/180	625.15	£6.55
	50		W	5/100	625.2	£8.67
Access plug						
	32		W	10/350	637.125	£2.80
	40		W	10/320	637.15	£2.80
	50		W	10/180	637.2	£4.01

Prices shown are for one item excluding VAT











Waste Systems - 600 ABS Solvent						
	Size mm	Angle	Col	Pack/Box	Code	Price Each
Swept tee all socket						
	32	91¼	W	10/120	604.125.91	£4.12
	40	91¼	W	10/90	604.15.91	£5.20
	50	91¼	W	5/45	604.2.91	£10.17
Junction						
	32	135	W	10/120	604.125.135	£5.04
	40	135	W	5/80	604.15.135	£6.53
	50	135	W	5/80	604.2.135	£10.17
Swept cross all socket						
	40	91¼	W	5/105	606.15.91	£12.95
	50	91¼	W	5/55	606.2.91	£13.56
Socket reducer						
	32		W	20/640	624.15.125	£3.02
	50		W	10/350	624.2.125	£4.77
	50		W	10/350	624.2.15	£5.33
Male iron with socket						
	For solvent weld connection of PVC waste pipe or fitting to BSP threaded female pipe or fitting.					
	32		W	5/300	617.125	£5.29
	40		W	5/220	617.15	£6.18
	50		W	5/160	617.2	£8.49
Female iron with socket						
	For solvent weld connection of PVC waste pipe or fitting to BSP threaded male pipe or fitting.					
	32		W	10/270	612.125	£5.48
	40		W	10/200	612.15	£5.48
	50		W	5/140	612.2	£7.90

Prices shown are for one item excluding VAT

Colours: G - Grey B - Black W - White T - Terracotta

Overflow - 500 Overflow











	Size mm	Angle	Col	Pack/Box	Code	Price Each	
Waste pipe							
	19 (4m)		W	20	500.75.40	£13.11	
Straight coupler double socket							
	19		W	50/1000	510.75	£3.58	
Bend double socket							
	19	91¼	A	W	50/750	501.75.91	£4.22
	19	135	A	W	50/1100	501.75.135	£4.25
Branch							
	19	91¼	A	W	20/900	504.75.91	£4.59
Socket Reducer							
	19/32		W	20/900	524.75	£4.99	
Pipe fixing clip - plastic							
	19		W	50/2500	540.75	£1.30	
Straight tank connector							
	19		W	10/250	511.75	£5.67	
Bent tank connector 90°							
	19		A	W	10/200	502.75.90	£6.72
Female to PVCu connector							
	19		W	10/750	512.75	£6.09	
Reverse nut connector							
	19		W	20/300	519.75	£1.73	
Tundish							
	19		W	5/100	590.75	£35.32	

Prices shown are for one item excluding VAT

Waste Traps - 400













	Size mm	Angle	Col	Pack/Box	Code	Price Each
Bottle trap						
	32	▽	W	5/60	411.125	£6.97
	40	▽	W	5/60	411.15	£8.55
Bottle trap anti-syphon						
	32	▽A	W	5/60	411AS.125	£9.49
	40	▽A	W	5/60	411AS.15	£11.13
Resealing bottle trap						
	32	▽	W	5/60	415.125	£9.13
	40	▽	W	5/60	415.15	£10.92
Bottle trap - adjustable telescopic						
	32	▽A	W	5/60	411T.125	£8.80
	40	▽A	W	5/60	411T.15	£10.52
Bottle trap anti-syphon - adjustable telescopic						
	32	▽A	W	5/60	421AS.125	£11.01
	40	▽A	W	5/60	421AS.15	£12.79
Resealing bottle trap - adjustable telescopic						
	32	▽	W	5/60	421.125	£10.80
	40	▽	W	5/50	421.15	£12.51
Tubular swivel P trap						
	32	▽	W	5/80	431.125	£6.01
	40	▽	W	5/60	431.15	£7.16
Tubular swivel P trap - adjustable telescopic						
	32	A	W	5/80	431T.125	£7.50
	40	A	W	5/60	431T.15	£8.72
Tubular swivel P trap anti-syphon						
	32	▽A	W	5/80	431AS.125	£8.49
	40	▽A	W	5/60	431AS.15	£9.50







Prices shown are for one item excluding VAT

Colours: G - Grey B - Black W - White T - Terracotta

Soil & Waste

Waste Traps - 400							
	Size mm	Angle	Col	Pack/Box	Code	Price Each	
Tubular swivel P trap anti-syphon - adjustable telescopic							
	75mm water seal.						
	32	♥	W	5/60	431TAS.125	£9.99	
	40	♥	W	5/60	431TAS.15	£10.38	
P to S trap conversion bend							
	To convert tubular P traps to S traps.						
	32	♥	W	10/140	407.125.90	£3.42	
	40	♥	W	5/250	407.15.90	£3.86	
Tubular swivel S trap							
	75mm water seal.						
	32	♥	W	5/60	432.125	£7.29	
	40	♥	W	5/40	432.15	£8.69	
Running trap							
	75mm water seal.						
	32	♥	W	5/60	445.125	£9.17	
	40	♥	W	5/50	445.15	£9.77	
Running trap anti-syphon							
	75mm water seal.						
	32	♥	W	5/60	445AS.125	£11.62	
	40	♥	W	5/50	445AS.15	£12.20	
Washing machine half trap							
	75mm water seal with adaptor.						
	40	♥	W	5/40	433.15	£11.99	
Washing machine half trap anti-syphon							
	75mm water seal with adaptor.						
	40	♥	W	5/40	433AS.15	£14.75	
Washing machine trap with upstand							
	75mm water seal with 0.6m upstand and 2 clips.						
	40	♥	W	5/130	434.15	£11.03	
Washing machine trap anti-syphon with upstand							
	75mm water seal with 0.6 upstand and 2 clips.						
	40	♥	W	5/10	434AS.15	£13.51	
Bath trap							
	20mm water seal.						
	40		W	5/80	455.15	£6.97	

Prices shown are for one item excluding VAT

Waste Traps - 400							
	Size mm	Angle	Col	Pack/Box	Code	Price Each	
Low level bath trap							
	38mm water seal.						
	40	♥	W	5/30	457.15	£7.29	
Low level bath trap c/w overflow hose and cp rose							
	38mm water seal.						
	40	♥	W	5/25	459.15	£17.06	
Low level bath trap anti-syphon c/w overflow hose and cp rose							
	75mm water seal.						
	40	♥	W	5/25	451.15	£20.75	
Shower Trap							
	19mm water seal, 70mm grid.						
	40		W	5/60	482.15	£12.52	
	40		C/P	20/10	483.15	£14.92	
Shower trap with 45° adjustable waste							
	50mm water seal, 70mm grid.						
	40		W	5/50	484.15	£16.06	
	40		C/P	5/45	486.15	£18.11	
Condensate trap							
	40						
			W	1/30	420.15	£14.11	

Prices shown are for one item excluding VAT

WC Pan Connectors - 490							
	Size mm	Angle	Col	Pack/Box	Code	Price Each	
Straight WC connector fin seal							
	110						
		♥	W	5/40	499P.4.00	£6.75	
90° WC connector fin seal bend							
	110						
	90	♥	W	5/15	499P.4.90	£8.01	
14° WC connector fin seal spigots							
	110						
	14	♥	W	5/35	499P.4.104	£6.63	
40mm offset WC connector fin seal							
	110						
		♥	W	5/30	494P1.4.00	£6.63	

Prices shown are for one item excluding VAT





Colours: G - Grey B - Black W - White T - Terracotta

WC Pan Connectors - 490

	Size mm	Angle	Col	Pack/Box	Code	Price Each	
12mm offset WC connector fin seal							
	110	R	W	5/40	494P2.4.00	£6.63	
Swivel connector 0-30° fin seal							
Adjustable 0-30°							
	110	0-30	R	W	5/20	498P.4.030	£17.22
Swan neck WC connector 90° fin seal							
	110	90	R	W	5/15	496P.4.90	£14.66
Long 90° WC connector fin seal							
225mm leg							
	110	90	R	W	5/10	491P.4.90	£8.38
90° WC connector with 32mm boss fin seal							
	110	90	R	W	5/15	495P.4.90	£19.83
Extension 200mm							
	110	R	W	5/25	493P.00	£6.09	
WC manifold connectors fin seal spigot							
When used in conjunction with a branch 104, up to seven WC pans can be connected either side of the soil stack.							
	110	5	R	W	6	499.4.05	£17.30
	110	14	R	W	6	499.4.14	£17.30
	110	24	R	W	5/10	499.4.24	£17.30
	110	34	R	W	5/10	499.4.34	£17.30
	110	9		W	1	S499.4.09	£33.55
	110	18		W	1	S499.4.18	£33.55
	110	29		W	1	S499.4.29	£33.55
	110	*		W	1	S499.4.X	£33.55
*Customer to specify angle on order							
WC frame manifold bend connectors fin seal spigot							
	110	5	R	B	5/10	497.35.05	£47.22
	110	14	R	B	5/10	497.35.14	£47.22
	110	24	R	B	5/10	497.35.24	£47.22
	110	34	R	B	5/10	497.35.34	£47.22
	110	9	R	B	1/12	F497.35.09	£47.22
	110	18	R	B	1/12	F497.35.18	£47.22
	110	29	R	B	1/12	F497.35.29	£47.22
WC connector 90° spigot outlet							
For connection of WC pans to existing soil or waste pipework previously connected to traditional 'S' mode pan.							
	110	90	R	W	5	499.4.90	£22.76

Prices shown are for one item excluding VAT



WC Pan Connectors - 490

	Size mm	Angle	Col	Pack/Box	Code	Price Each	
WC connectors socket outlet							
	110	2½	R	W	5/50	498.4.02	£10.48
	110	90	R	W	5/25	498.4.90	£16.94
90° WC turned connector socket outlet							
Adjustable, for connecting non BS 5503 WC pans to soil pipes							
	110	9½	R	W	5/20	492.4.5	£27.02
WC straight connector socket outlet							
For connecting non BS 5503 WC pans to soil pipes							
	110		R	W	5/25	495.4.5	£18.89

Prices shown are for one item excluding VAT

Accessories



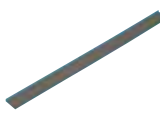









	Size mm	Angle	Col	Pack/Box	Code	Price Each	
Firetrap Collar							
An intumescent sleeve is designed to prevent the spread of fire and smoke where PVCu pipes penetrate a fire rated compartment wall or floor.							
	40		R	Red	5/50	1625.40R	£15.74
	55		R	Red	5/50	1625.55R	£16.58
	63		R	Red	5/25	1625.63R	£19.21
	75		R	Red	5/10	1625.75R	£21.07
	82		R	Red	5/10	1625.82R	£17.97
	90		R	Red	5/10	1625.90R	£18.80
	110		R	Red	5/10	1625.110R	£22.41
	125		R	Red	5/10	1625.125R	£23.48
	160		R	Red	5/10	1625.160R	£35.29
	200		R	Red	5/10	1625.200R	£114.74
	250		R	Red	5/10	1625.250R	£240.14
	315		R	Red	5/10	1625.315R	£693.72
Note: As a Firetrap product a different discount structure applies.							
Toggle bolt							
To clamp 112 and 115 Boss Connectors while solvent-welding.							
				Self	1/50	9115	£57.84
Packing piece							
For use with 140 and 142 Pipe Brackets and 191 Intermediate Support Brackets.							
	160		G		1/100	9104.6	£12.92
Cut to size							

Prices shown are for one item excluding VAT

Colours: G - Grey B - Black W - White T - Terracotta

Soil & Waste

Accessories						
	Size mm	Angle	Col	Pack/Box	Code	Price Each
Pipe marking template						
	Marking guide for Terrain Soil Systems, access and boss connection.					
	110		Blue	1	9105.500T	£26.04
WC pan seal - soil						
	Material: EPDM Replacement seal for pan outlet diameter 951/4-121mm. For use on 102.4.5 and 125.4.5.					
	110		B	1/100	9124	£17.19
HDPE WC pan connector fin seal						
	Adapts standard WC connectors to fit HDPE 110mm.					
	110		B	150	499P.4.908	£5.14
Spare seal rings - soil						
	Material: EPDM Suitable for: – Soil system expansion sockets and soil pipe – Use with 126 Adaptors to Cast Iron – Soil fittings (as listed).					
	Push Fit Soil (P) range and 4DI600					
	110		B	1	9116.4	£3.61
	Push Fit Soil (P) range					
	160		B	1	9116.6	£6.82
	109/111/111.S/126/132					
	82		B	1	9120	£5.26
	103/105/109/111/111.S/126/132/137					
	110		B	1	9119.B	£5.98
Spare seal ring - waste						
	Material: EPDM Suitable for: – 200 Waste System Fittings to accept pipe manufactured to BS 5255. – Use with boss adaptors (117)					
	Acceptable for: – copper pipe to BS 659 and BS 2781.					
	32		B	1	9132.125	£0.96
	40		B	1	9132.15	£1.12
	50		B	1	9132.2	£1.50
Manifold insert - spare						
	Material: EPDM.					
	40		B	1	9113	£2.01
Manifold plug - spare						
	Material: Polypropylene.					
	40		G	1	9114	£2.25
Cleaning fluid						
	Material: Acetone. For cleaning PVCu pipe and fittings before applying Liquid Weld. Screw top caps.					
	125ml*			20	9101.125CF	£8.88
	250ml			10	9101.250CF	£18.05
	*Limited stock availability					

Accessories						
	Size mm	Angle	Col	Pack/Box	Code	Price Each
Lubricant						
	Material: Silicone grease Soluble lubricant. For lubricating seal rings on expansion fittings.					
	250ml	Tub (silicone)		10/40	9136.250L	£64.51
	500ml	Tub (soluble)		10/20	9136.500L	£13.32
Liquid weld						
	For solvent jointing of PVCu and ABS pipes and fittings. Cap incorporates integral brush.					
	250ml	♥		24	9100.250SW	£26.37
	500ml	♥		12	9100.500SW	£48.72

Prices shown are for one item excluding VAT

Prices shown are for one item excluding VAT

Terrain

Index			
Code	Colour	Price	Page
100 Solvent			
100.3.30	GW	£73.43	6
100.3.40	GW	£96.15	6
100.4.30	GBW	£71.43	6
100.4.40	GBW	£95.19	6
100.6.30	G	£194.57	6
100.6.40	G	£254.31	6
101.3.92	GW	£32.82	6
101.3.135	GBW	£32.82	6
101.4.025	G	£71.35	6
101.4.92	GBW	£37.31	6
101.4.104	G	£38.85	6
101.4.112	GB	£38.85	6
101.4.135	GBW	£37.31	6
101.6.92	G	£97.74	6
101.6.135	G	£95.60	6
103.4.92	GBW	£103.51	7
104.3.92	GW	£45.84	6
104.3.135	G	£45.84	6
104.4.92	GBW	£49.36	6
104.4.104	G	£62.36	6
104.4.135	GBW	£51.49	6
104.4.924	GBW	£61.21	6
104.6.92	G	£110.19	6
104.6.135	G	£210.30	6
104.64.92	G	£124.40	6
104.64.135	G	£130.82	6
104.104.92	GB	£64.34	6
104.412.92	G	£113.87	6
104.422.92	G	£116.01	6
105.4.92	G	£86.37	7
106.3.92	G	£47.98	7
106.4.92	GW	£106.65	7
106.4.135	G	£130.30	7
106.6.135	G	£79.16	7
106.64.92	G	£231.75	7
106.104.92	G	£124.68	7
106.490.12	G	£255.18	7
106.490.22	G	£255.18	7
106.490.92	G	£220.17	7
107.3.92	G	£32.42	6
107.4.025	G	£71.62	6
107.4.92	GBW	£36.16	6
107.4.135	GBW	£40.58	6
109.3	G	£8.47	6
109.4	GBW	£7.90	6
109.6	G	£22.34	6
110.3	GW	£13.06	6
110.4	GBW	£15.89	6
110.6	G	£47.12	6
111.3	GW	£19.97	6
111.4	GBW	£19.40	6
111.6	G	£61.48	6
111.5.3	G	£41.48	6
111.5.4	GB	£34.89	6
111.5.6	G	£75.39	6
112.3.15	G	£18.34	8
112.4.2	G	£18.09	8
112.4.15	G	£17.82	8
112.4.125	G	£17.82	8
112.6.2	G	£25.93	8
117.2.90	GW	£12.48	9
117.2.150	G	£11.33	9
117.2	GBW	£9.94	9
117.15.90	GW	£10.41	9
117.15	GBW	£6.98	9
117.125	GBW	£6.98	9
119.412.15	G	£68.18	9
120.3.2	G	£28.15	8
120.4.2	GB	£21.69	9
120.4.15	GBW	£13.35	8
120.4.125	GBW	£13.35	8

Index			
Code	Colour	Price	Page
120.6.2	G	£70.81	9
120.412.2	G	£22.12	9
120.412.15	G	£13.22	8
121.4.15	GB	£22.12	8
122.4.15	G	£25.33	8
122.4.125	G	£24.25	8
123.4	GBW	£14.08	8
124.3.2	GW	£19.87	9
124.4.2	GBW	£24.08	9
124.4.3	GBW	£24.82	9
124.6.4	G	£52.89	9
126.3.12	G	£24.18	9
126.4.12	G	£31.52	9
130.4	G	£22.41	8
130.6	G	£43.11	8
131.3.200	G	£40.62	8
131.3	GB	£9.61	8
131.4.200	G	£38.77	8
131.4	GBW	£10.55	8
131.6	G	£33.24	8
132.4	G	£31.06	9
135.3	G	£45.45	7
135.4	GB	£43.36	7
135.6	G	£79.75	7
136.3	GW	£30.91	7
136.4	GBW	£35.41	7
136.6	G	£70.09	7
137.3	GW	£82.04	7
137.4	GBW	£50.41	7
138.4	GBW	£39.22	7
139.4	GB	£40.20	7
139.6	G	£62.91	7
140.3	Self	£10.62	7
140.4	Self	£10.73	7
140.6	Self	£26.54	7
143.3	GBW	£7.58	8
143.4	GBW	£6.90	8
144.4	BW	£14.31	8
149.16.00	Alu/B	£111.89	8
149.18.22	Alu/B	£114.71	8
149.24.22	Alu/B	£155.03	8
150.3	G	£9.47	8
150.4	GBW	£9.08	8
150.6	G	£25.46	8
152.4	GB	£41.59	8
152.6	G	£107.82	8
153.3	W	£108.79	8
153.4	W	£108.79	8
190.3	Self	£65.85	7
190.4	Self	£69.62	7
190.6	Self	£113.57	7
191.3	Self	£33.52	7
191.4	Self	£35.40	7
191.6	Self	£48.74	7
104AS.6.135	G	£70.09	6
107P.6.135	G	£101.51	6
115P.4	G	£14.95	9
4DW3	B	£32.64	9
6592/DVV	G	£54.62	7
S105.6.135	G	£81.14	7
100P Pushfit			
100.8.40	G	£303.82	9
100.10.40	G	£434.64	9
111.SP4	G	£27.65	9
117.2	GBW	£9.94	11
117.15	GBW	£6.98	11
117.125	GBW	£6.98	11
100P.3.30	G	£64.98	9
100P.3.40	G	£88.05	9
100P.4.30	GB	£64.17	9
100P.4.40	G	£86.19	9
100P.6.30	G	£179.19	9

Index			
Code	Colour	Price	Page
100P.6.40	G	£239.01	9
101D.4.92	G	£41.04	10
101P.3.92	G	£32.56	10
101P.4.92	GB	£33.35	10
101P.4.112	G	£38.79	10
101P.6.92	G	£107.19	10
101P.8.92	G	£182.52	10
103P.3.92	G	£128.22	11
103P.6.92	G	£247.99	11
104E.4.92	G	£52.02	10
104E.4.135	G	£52.22	10
104E.412.92	G	£116.66	10
104P.3.92	G	£52.08	10
104P.3.135	G	£84.90	10
104P.4.92	GB	£44.98	10
104P.4.112	G	£66.14	10
104P.4.135	G	£47.30	10
104P.6.92	G	£124.19	10
104P.6.135	G	£97.14	10
104P.8.92	G	£261.18	10
104P.8.135	G	£114.78	10
104P.10.135	G	£298.02	10
104P.64.92	G	£122.21	10
104P.64.135	G	£122.21	10
104P.84.135	G	£155.92	10
104P.86.135	G	£236.60	10
104P.106.135	G	£230.62	10
104P.108.135	G	£237.04	10
105P.3.92	G	£117.50	11
105P.4.92	G	£109.81	11
105P.6.135	G	£214.78	11
106E.490.12	G	£244.76	10
106P.4.92	G	£122.55	11
106P.490.92	G	£111.11	10
107P.3.135	G	£28.63	10
107P.4.025	G	£73.29	10
107P.4.92	G	£34.41	10
107P.4.135	GB	£33.67	10
107P.4.VAR	G	£65.50	10
107P.6.135	G	£101.51	10
107P.8.135	G	£124.68	10
107P.10.135	G	£165.97	10
110P.3	G	£26.19	9
110P.4	GB	£22.20	9
110P.6	G	£55.19	9
110P.8	G	£62.14	9
110P.10	G	£97.20	9
111P.3	G	£14.58	9
111P.4	GB	£15.52	9
111P.6	G	£50.84	9
112P.4.2	GB	£15.32	11
112P.4.15	GB	£15.15	11
112P.4.125	GB	£15.15	11
115P.4	G	£14.95	11
123P.3	G	£19.30	11
123P.4	GB	£18.61	11
123P.312	G	£39.86	11
124P.3.2	G	£24.47	11
124P.4.2	G	£32.49	11
124P.4.3	G	£32.49	11
124P.6.4	G	£49.06	11
124P.8.4	G	£50.73	11
124P.8.6	G	£51.73	11
124P.10.4	G	£57.33	11
124P.10.6	G	£65.28	11
124P.10.8	G	£70.89	11
136P.3	GB	£26.56	11
136P.4	GB	£29.88	11
136P.6	G	£73.65	11
139P.3	GB	£65.24	11
139P.4	GB	£60.93	11
139P.6	G	£134.25	11
139P.8	G	£90.52	11

Index			
Code	Colour	Price	Page
139P.10	G	£336.24	11
6592/DVV	G	£54.62	11
200 Solvent			
201.2.91	GBW	£6.61	12
201.2.135	GBW	£6.61	12
201.2.165	G	£8.90	12
201.15.91	GBW	£3.73	12
201.15.135	GBW	£3.73	12
201.15.165	G	£6.76	12
201.125.91	GBW	£3.38	12
201.125.135	GBW	£3.38	12
201.125.165	G	£5.23	12
202.15.91	GBW	£3.39	12
202.125.91	GBW	£3.07	12
204.2.91	GBW	£11.18	13
204.2.135	GW	£11.18	13
204.15.91	GBW	£5.73	13
204.15.135	GW	£7.19	13
204.125.91	GBW	£4.53	13
204.125.135	GW	£5.54	13
206.2.91	GW	£14.91	12
206.2.135	G	£99.45	12
206.15.91	GW	£14.25	12
207.2.92	GW	£9.02	12
207.2.135	GW	£9.18	12
207.15.92	GBW	£6.32	12
207.15.135	GBW	£6.57	12
207.15.150	G	£6.68	12
207.125.92	GBW	£5.53	12
207.125.135	GBW	£5.61	12
207.125.150	G	£5.84	12
212.2	G	£8.69	14
212.15	G	£6.03	14
212.125	G	£6.03	14
213.2	GW	£8.69	14
213.15	GW	£6.03	14
213.125	GW	£5.15	14
216.2	G	£9.91	14
216.15	G	£	

Soil & Waste

Index			
Code	Colour	Price	Page
281.64	GT	£45.04	13
282.6	GW	£15.99	13
283.6	Self	£33.72	13
284.6	GW	£20.38	13
285.6	Self	£34.47	13
4DW200	B	£31.93	13
300 Pushfit			
300.15.30	W	£10.57	14
300.125.30	W	£8.52	14
301.15.91	W	£2.84	14
301.15.135	W	£2.78	14
301.125.91	W	£2.78	14
301.125.135	W	£2.84	14
302.15.90	W	£2.78	14
302.125.90	W	£2.78	14
304.15.91	W	£3.11	14
304.125.91	W	£3.11	14
307.15.90	W	£2.84	14
307.125.90	W	£2.84	14
310.15	W	£2.78	14
310.125	W	£2.84	14
311.15	W	£2.84	14
311.125	W	£2.84	14
323.15.125	W	£3.04	14
337.15	W	£2.84	14
337.125	W	£2.84	14
340.15	W	£0.96	14
340.125	W	£0.96	14
PRD100		£0.91	14
PRD101		£0.91	14
PS38	W	£3.73	14
600 ABS Solvent Waste			
600.2.30		£20.74	15
600.15.30		£18.86	15
600.125.30		£14.15	15
601.2.91	W	£6.00	15
601.2.135	W	£6.00	15
601.15.91	W	£3.39	15
601.15.135	W	£3.39	15
601.125.91	W	£3.07	15
601.125.135	W	£3.07	15
602.15.91	W	£3.09	15
602.125.91	W	£2.80	15
604.2.91	W	£10.17	15
604.2.135	W	£10.17	15
604.15.91	W	£5.20	15
604.15.135	W	£6.53	15
604.125.91	W	£4.12	15
604.125.135	W	£5.04	15
606.2.91	W	£13.56	15
606.15.91	W	£12.95	15
607.15.135	W	£5.97	15
607.125.135	W	£5.12	15
610.2		£5.48	15
610.15		£2.99	15
610.125		£3.02	15
612.2	W	£7.90	15
612.15	W	£5.48	15
612.125	W	£5.48	15
617.2	W	£8.49	15
617.15	W	£6.18	15
617.125	W	£5.29	15
624.2.15	W	£5.33	15
624.2.125	W	£4.77	15
624.15.125	W	£3.02	15
625.2	W	£8.67	15
625.15	W	£6.55	15
625.125	W	£5.31	15
637.2	W	£4.01	15

Index			
Code	Colour	Price	Page
637.15	W	£2.80	15
637.125	W	£2.80	15
500 Overflow			
500.75.40	W	£13.11	16
501.75.91	W	£4.22	16
501.75.135	W	£4.25	16
502.75.90	W	£6.72	16
504.75.91	W	£4.59	16
510.75	W	£3.58	16
511.75	W	£5.67	16
512.75	W	£6.09	16
519.75	W	£1.73	16
524.75	W	£4.99	16
540.75	W	£1.30	16
590.75	W	£35.32	16
400 Traps			
407.15.90	W	£3.86	17
407.125.90	W	£3.42	17
411.15	W	£8.55	16
411.125	W	£6.97	16
415.15	W	£10.92	16
415.125	W	£9.13	16
420.15	W	£14.11	17
421.15	W	£12.51	16
421.125	W	£10.80	16
431.15	W	£7.16	16
431.125	W	£6.01	16
432.15	W	£8.69	17
432.125	W	£7.29	17
433.15	W	£11.99	17
434.15	W	£11.03	17
445.15	W	£9.77	17
445.125	W	£9.17	17
451.15	W	£20.75	17
455.15	W	£6.97	17
457.15	W	£7.29	17
459.15	W	£17.06	17
482.15	W	£12.52	17
483.15	C/P	£14.92	17
484.15	W	£16.06	17
486.15	C/P	£18.11	17
411AS.15	W	£11.13	16
411AS.125	W	£9.49	16
411T.15	W	£10.52	16
411T.125	W	£8.80	16
421AS.15	W	£12.79	16
421AS.125	W	£11.01	16
431AS.15	W	£9.50	16
431AS.125	W	£8.49	16
431T.15	W	£8.72	16
431T.125	W	£7.50	16
431TAS.15	W	£10.38	17
431TAS.125	W	£9.99	17
433AS.15	W	£14.75	17
434AS.15	W	£13.51	17
445AS.15	W	£12.20	17
445AS.125	W	£11.62	17
490 WC Pan Connectors			
492.4.5	W	£27.02	18
495.4.5	W	£18.89	18
497.35.05	B	£47.22	18
497.35.14	B	£47.22	18
497.35.24	B	£47.22	18
497.35.34	B	£47.22	18
498.4.02	W	£10.48	18
498.4.90	W	£16.94	18

Index			
Code	Colour	Price	Page
499.4.05	W	£17.30	18
499.4.14	W	£17.30	18
499.4.24	W	£17.30	18
499.4.34	W	£17.30	18
499.4.90	W	£22.76	18
491P.4.90	W	£8.38	18
493P.00	W	£6.09	18
494P1.4.00	W	£6.63	17
494P2.4.00	W	£6.63	18
495P.4.90	W	£19.83	18
496P.4.90	W	£14.66	18
498P.4.030	W	£17.22	18
499P.4.00	W	£6.75	17
499P.4.90	W	£8.01	17
499P.4.104	W	£6.63	17
F497.35.09	B	£47.22	18
F497.35.18	B	£47.22	18
F497.35.29	B	£47.22	18
S499.4.09	W	£33.55	18
S499.4.18	W	£33.55	18
S499.4.29	W	£33.55	18
S499.4.X	W	£33.55	18
Accessories			
1625.110R	Red	£22.41	18
1625.125R	Red	£23.48	18
1625.160R	Red	£35.29	18
1625.200R	Red	£114.74	18
1625.250R	Red	£240.14	18
1625.315R	Red	£693.72	18
1625.40R	Red	£15.74	18
1625.55R	Red	£16.58	18
1625.63R	Red	£19.21	18
1625.75R	Red	£21.07	18
1625.82R	Red	£17.97	18
1625.90R	Red	£18.80	18
9100.250SW		£26.37	19
9100.500SW		£48.72	19
9101.125CF		£8.88	19
9101.250CF		£18.05	19
9104.6	G	£12.92	18
9105.500T	Blue	£26.04	19
9113	B	£2.01	19
9114	G	£2.25	19
9115	Self	£57.84	18
9116.4	B	£3.61	19
9116.6	B	£6.82	19
9119.B	B	£5.98	19
9120	B	£5.26	19
9124	B	£17.19	19
9132.2	B	£1.50	19
9132.15	B	£1.12	19
9132.125	B	£0.96	19
9136.250L		£64.51	19
9136.500L		£13.32	19
499P.4.908	B	£5.14	19

Prices shown are for one item excluding VAT

Prices shown are for one item excluding VAT

Colours: G - Grey B - Black W - White T - Terracotta

Polypipe Advantage

Looking for a service to help deliver time, resource and cost savings on your next project?

Introducing Polypipe Advantage, from Polypipe Building Services. A design, fabrication, delivery, technical and customer support service that gives you the Advantage.

What is it?

A service that delivers designed and fabricated building service solutions with dedicated project management from design through to delivery, installation and onsite support. We make it. Simple.

How we provide Advantage?

By working together to deliver just-in-time fabricated solutions and supporting contractors from design through to delivery and install we provide contractors the Advantage by;

- Reducing planning time through dedicated design, project & logistics management
- Reducing on-site labour costs
- Reducing on-site labour time
- Reducing on-site waste
- Reducing on-site storage

Why recommend Polypipe Advantage?

With shifts in the construction labour market, an increasing focus on environmental issues and pressure to deliver construction projects on time, contractors will be looking to the supply chain to help alleviate challenges onsite, so there's never been a better time to offer these services.

Whichever building services system you require to help overcome your unique project challenges, we make it. Simple. Polypipe Advantage. More than fabrication.

The Service



Design



Dispatch and delivery

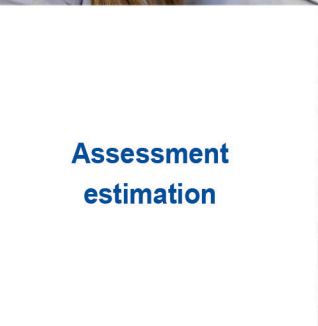

Assessment estimation



Ordering and fabrication

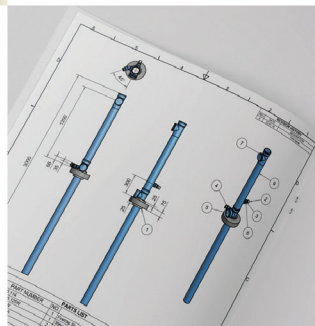
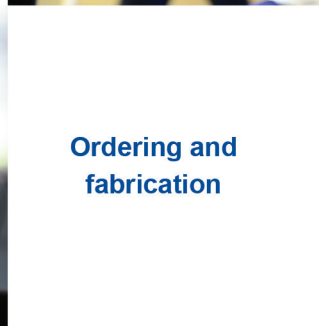

Merchant integration

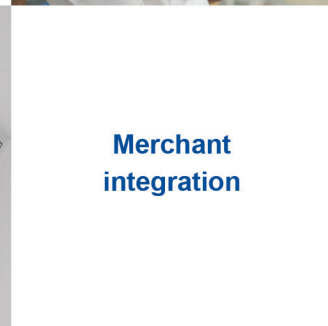



POLYPIPE
ADVANTAGE



MORE THAN FABRICATION



We make it. Simple.

Advantage from Polypipe Building Services. Providing the solutions you need, to help make the complex simple.

Designing and fabricating systems based on your unique project requirements, Advantage is with you at every stage – from initial planning and project management, through to final delivery – helping you overcome any twists or turns along the way.

Advantage. More than fabrication.

Discover simplicity, visit: polypipe.com/polypipeadvantage



Terrain FUZE



Introduction

A modern high density polyethylene system with many advantages over cast iron and other traditional systems. Terrain FUZE is a top-to-bottom solution for all above ground drainage and many chemical waste applications. It allows specifiers and installers to benefit by providing them maximum flexibility in the design process.

Utilising the intrinsic properties of high-density polyethylene, Terrain FUZE offers greater benefits above and beyond more traditional materials and performs significantly better when tested for impact and abrasion resistance, chemical corrosion and extreme temperatures. The lightweight nature of Terrain FUZE allows the product to be installed quickly and efficiently, giving direct, resource-saving benefits to specifiers and installers.

HDPE offers exceptional performance above and beyond traditional pipe materials including:

- Suitable for use with Terrain Siphonic Roof Drainage (see page 45 for further details)
- Versatile application
- Highly resistant to impact even at low temperatures
- Highly resistant to chemical agents
- Corrosion resistant
- Abrasion resistant
- Lightweight and easy to install
- Ideal for Terrain fabrication service

Innovative Products

Terrain FUZE HDPE Manifolds



A product designed with the customer in mind, for many different scenarios. Featuring 12 perfectly situated bosses, this allows for multiple different entry points; all of which can be used simultaneously due to the engineered central baffle removing cross flow. See page 28 for further details. Also perfect for our Advantage service, see page 22 for further details.

Terrain Anchor / Guide Bracket



This dual use guide or anchor bracket has a simple clip, which once removed, allows adjustability for the product to go from guide to anchor. This multi-functional product is engineered to ease installation and lessen time taken. See page 34 for further details.

Terrain P.A.P.A. and Pleura Vent Systems



The Terrain P.A.P.A. and Pleura Vent Systems allow for an engineered approach in the removal of secondary venting and reduction of roof top penetrations. See page 39 for further details.

Pipes

Size mm	Packing Lengths	Pack Quantity	Code	Price Each
HDPE Pipe - 3 metre length				
40	150	50	900.40.30B	£10.52
50	150	50	900.50.30B	£12.56
56	120	40	900.56.30B	£15.11
63	105	35	900.63.30B	£17.29
75	90	30	900.75.30B	£19.92
90	60	20	900.90.30B	£29.62
110	45	15	900.110.30B	£37.46
125	30	10	900.125.30B	£53.18
160	30	10	900.160.30B	£85.84
HDPE Pipe - 5 metre length				
40	550	110	900.40.50B	£17.62
50	430	86	900.50.50B	£20.93
56	490	98	900.56.50B	£25.14
63	330	66	900.63.50B	£28.81
75	290	58	900.75.50B	£33.21
90	290	58	900.90.50B	£49.33
110	285	57	900.110.50B	£62.42
125	170	34	900.125.50B	£88.65
160	50	10	900.160.50B	£143.05
200	50	10	900.200.50B	£185.37
250	40	8	900.250.50B	£297.17
315	30	6	900.315.50B	£463.42
HDPE Pipe - 5.8 metre length - for Siphonic applications				
200			900.200.58H	£207.98
250			900.250.58H	£309.93
315			900.315.58H	£470.29

RECOMMENDED

Electrofusion Couplings

Size mm	Pack Quantity	Code	Price Each
HDPE electrofusion couplings			
40	20	910.40B	£5.34
50	16	910.50B	£5.50
56	16	910.56B	£5.53
63	10	910.63B	£6.79
75	18	910.75B	£7.99
90	8	910.90B	£7.72
110	10	910.110B	£8.25
125	10	910.125B	£14.21
160	8	910.160B	£19.76
200	10	910.200B	£137.62
250	55	910.250B	£227.50
315	34	910.315B	£258.04

Ring Seal Couplings

Size mm	Pack Quantity	Code	Price Each
HDPE ring seal socket			
110	1	910P.110B	£54.77
160	5	910P.160B	£197.95
200	1	910P.200B	£251.92
250	1	910P.250B	£377.88
315	1	910P.315B	£521.83

Ring Seal Couplings

Size mm	Pack Quantity	Code	Price Each
HDPE expansion joint with cap			
40	20	911.40B	£10.79
50	30	911.50B	£10.74
56	30	911.56B	£10.30
63	20	911.63B	£12.80
75	20	911.75B	£13.65
90	15	911.90B	£14.04
110†	10	911.110B	£13.43
125	10	911.125B	£21.89
160	80	911.160B	£39.89
200	1	911.200B	£184.14
250*	1	911.250B	£255.51
315*	8	911.315B	£462.45
†For Rigid pipe support *without cap.			
HDPE ring seal adaptors with cap			
40	130	927.40B	£4.13
50	80	927.50B	£4.93
56	80	927.56B	£5.14
63	30	927.63B	£8.27
75	30	927.75B	£7.83
90	25	927.90B	£8.87
110	20	927.110B	£9.27
125	20	927.125B	£15.90
160	15	927.160B	£31.02
200	1	927.200B	£163.44
250*	1	927.250B	£268.97
315*	1	927.315B	£310.38
*without cap.			

HDPE short ring seal socket

Butt weld only.			
90/90	25	909.90B	£13.37
110/110	50	909.110B	£13.37

HDPE sliding connector

110	16	911S.110B	£101.79
160	10	911S.160B	£197.95
200	1	911S.200B	£269.91
250	1	911S.250B	£377.88
315	1	911S.315B	£521.83

HDPE female PVC adaptor with ring seal

90/100	10	925.90100B	£24.29
110/100	10	925.110100B	£25.21

HDPE male PVC adaptor with ring seal

110/100	15	9113.110100B	£14.45
---------	----	--------------	--------

RECOMMENDED

HDPE - PVC ring seal adaptor

PVC, PP or ABS Size (mm)			
40 x 36	5	927.4036B	£8.09
50 x 36	5	927.5036B	£8.12
50 x 43	5	927.5043B	£8.15
56 x 36	5	927.5636B	£8.15
56 x 43	5	927.5643B	£8.17

NEW MECHANICAL COUPLING



COST EFFECTIVE

The Mechanical Coupling is a lightweight and cost effective jointing method for Gravity Drainage Pipe Application.



DESIGN

Engineered to meet high demands of sectors where reliable, durable and aesthetically pleasing pipecouplings are required.



LIFE CAPABILITIES

Extensive life capabilities from the stainless steel case and EPDM gasket material.



DIN 86128 FORM F

Coupling dimensions approved to DIN 86128 Form F standard.



PERFORMANCE

Performance is approved to ASTM F1476 Type 11 Class 3 flexible and unrestricted standard.

PRODUCT INFORMATION BELOW.

NEW

Mechanical Couplings

Size mm	Pack Quantity	Code	Price Each
HDPE mechanical coupling			
For joining HDPE to HDPE.			
90	24	9110.90B	£19.47
110	12	9110.110B	£24.99
160	8	9110.160B	£31.18
For joining HDPE to BS416 Cast Iron.			
90	24	9110.90C	£34.71
110	12	9110.110C	£30.35
160	8	9110.160C	£56.70

Prices shown are for one item excluding VAT

Bends

Size mm	Pack Quantity	Code	Price Each
HDPE 90° bend			
Butt weld only.			
40	100	907.40.90B	£2.44
50	50	907.50.90B	£2.88
56	25	907.56.90B	£3.49
63	20	907.63.90B	£4.11
75	25	907.75.90B	£6.18
90	15	907.90.90B	£8.27
110	8	907.110.90B	£8.27
125	10	907.125.90B	£12.80
160	100	907.160.90B	£27.90
200*	1	907.200.90B	£136.33
250*	14	907.250.90B	£227.61
315*	1	907.315.90B	£331.07
*Wide radius, and welded.			
HDPE 90° reducing bend			
63/50	50	901.6350.90B	£4.11
HDPE extended spigot bend			
56	20	902.56.90B	£3.88
HDPE 91.5° (88.5°) bend			
40	200	901.40.92B	£2.44
50	100	901.50.92B	£3.29
56	90	901.56.92B	£3.20
63	30	901.63.92B	£4.11
75	40	901.75.92B	£5.97
90	15	901.90.92B	£8.27
110	30	901.110.92B	£8.87
125	20	901.125.92B	£14.45
160	90	901.160.92B	£37.22
HDPE 112.5° (67.5°) bend			
110*	1	901.110.112B	£46.59
160*	1	901.160.112B	£72.24
200*	1	901.200.112B	£87.99
250*	1	901.250.112B	£144.29
315*	1	901.315.112B	£249.27
*Welded			
HDPE 45° bend			
40	5	901.40.135B	£2.44
50	5	901.50.135B	£2.45
56	120	901.56.135B	£2.88
63	80	901.63.135B	£3.70
75	50	901.75.135B	£4.74
90	30	901.90.135B	£6.79
110	24	901.110.135B	£6.79
125	15	901.125.135B	£10.94
160†	16	901.160.135B	£28.73
200*	32	901.200.135B	£79.23
250*	1	901.250.135B	£128.88
315*	10	901.315.135B	£178.75
*Welded			

Prices shown are for one item excluding VAT

Bends

	Size mm	Pack Quantity	Code	Price Each
HDPE 150° (30°) bend				
	110*	30	901.110.150B	£22.93
	160*		901.160.150B	£35.04
	200*		901.200.150B	£46.18
	250*		901.250.150B	£75.61
	315*		901.315.150B	£120.24
	*Welded			
HDPE 165° (15°) bend				
	110*	30	901.110.165B	£22.43
	160*		901.160.165B	£33.20
	200*		901.200.165B	£42.88
	250*		901.250.165B	£69.51
	315*		901.315.165B	£108.02
	*Welded			

Prices shown are for one item excluding VAT

Branches

	Size mm	Pack Quantity	Code	Price Each
HDPE 90° reducing branch				
	200/160*	1	904.200160.90B	£123.08
	250/110*	1	904.250110.90B	£175.88
	250/125*	1	904.250125.90B	£175.88
	250/160*	1	904.250160.90B	£175.88
	250/200*	1	904.250200.90B	£175.88
	315/110*	1	904.315110.90B	£206.90
	315/125*	1	904.315125.90B	£206.90
	315/160*	1	904.315160.90B	£206.90
	315/200*	1	904.315200.90B	£206.90
		315/250*	1	904.315250.90B
	*Welded			

HDPE 45° Y branch

	40	80	904.40.135B	£5.96
	50	50	904.50.135B	£6.18
	56	40	904.56.135B	£5.85
	63	15	904.63.135B	£6.43
	75	20	904.75.135B	£7.21
	90	15	904.90.135B	£10.30
	110	16	904.110.135B	£12.37
	125	10	904.125.135B	£16.50
	160	45	904.160.135B	£57.09
	200*	16	904.200.135B	£184.14
	250*	8	904.250.135B	£310.38
	315*	1	904.315.135B	£455.23
		*Welded		

HDPE 45° reducing Y branch

	50/40	20	904.5040.135B	£6.18
	56/50	20	904.5650.135B	£5.85
	63/40	15	904.6340.135B	£6.43
	63/50	15	904.6350.135B	£6.43
	63/56	2	904.6356.135B	£6.43
	75/40	25	904.7540.135B	£7.21
	75/50	25	904.7550.135B	£7.21
	75/56	25	904.7556.135B	£7.21
	75/63	25	904.7563.135B	£7.21
	90/40	15	904.9040.135B	£10.30
	90/50	15	904.9050.135B	£10.30
	90/56	20	904.9056.135B	£10.74
	90/63	10	904.9063.135B	£10.74
	90/75	15	904.9075.135B	£10.74
	110/40	10	904.11040.135B	£12.37
	110/50	15	904.11050.135B	£12.37
	110/56	15	904.11056.135B	£12.37
	110/63	10	904.11063.135B	£12.37
	110/75	8	904.11075.135B	£12.37
	110/90	15	904.11090.135B	£12.37
	125/40	10	904.12540.135B	£16.50
	125/50	10	904.12550.135B	£16.50
	125/56	10	904.12556.135B	£16.50
	125/63	10	904.12563.135B	£16.50
	125/75	10	904.12575.135B	£16.50
	125/90	10	904.12590.135B	£16.50
125/110	10	904.125110.135B	£16.50	
160/75	50	904.16075.135B	£76.95	
160/90	50	904.16090.135B	£76.95	
160/110	7	904.160110.135B	£57.09	
160/125	1	904.160125.135B	£57.09	
200/75*	1	904.20075.135B	£114.80	
200/90*	20	904.20090.135B	£114.80	
200/110*	1	904.200110.135B	£123.08	
200/125*	1	904.200125.135B	£123.08	
200/160*	1	904.200160.135B	£128.27	











Prices shown are for one item excluding VAT

Branches

	Size mm	Pack Quantity	Code	Price Each
HDPE 90° branch				
	40	100	904.40.90B	£4.87
	50	70	904.50.90B	£6.18
	56	40	904.56.90B	£6.18
	63	40	904.63.90B	£6.43
	75	30	904.75.90B	£7.60
	90	20	904.90.90B	£9.69
	110	20	904.110.90B	£11.14
	125	15	904.125.90B	£16.50
	160†	8	904.160.90B	£62.05
	200*	1	904.200.90B	£123.08
	250*	1	904.250.90B	£175.88
	315*	1	904.315.90B	£248.30
		*Welded		
HDPE 90° reducing branch				
	50/40	25	904.5040.90B	£6.18
	56/50	25	904.5650.90B	£6.18
	63/40	20	904.6340.90B	£6.43
	63/50	20	904.6350.90B	£6.43
	75/40	25	904.7540.90B	£7.60
	75/50	20	904.7550.90B	£7.60
	75/56	30	904.7556.90B	£7.60
	75/63	20	904.7563.90B	£7.60
	90/40	20	904.9040.90B	£9.69
	90/50	20	904.9050.90B	£9.69
	90/56	40	904.9056.90B	£10.30
	90/63	20	904.9063.90B	£10.30
	90/75	20	904.9075.90B	£10.30
	110/40	15	904.11040.90B	£11.14
	110/50	10	904.11050.90B	£11.14
	110/56	10	904.11056.90B	£11.14
	110/63	10	904.11063.90B	£11.14
		110/75	10	904.11075.90B
110/90		20	904.11090.90B	£11.14
125/110		15	904.125110.90B	£16.50
160/110†		8	904.160110.90B	£62.05
160/125		1	904.160125.90B	£62.05
200/110*		1	904.200110.90B	£123.08
200/125*		1	904.200125.90B	£123.08





Prices shown are for one item excluding VAT

Branches





	Size mm		Pack Quantity	Code	Price Each
	HDPE 45° reducing Y branch				
	250/110*		10	904.250110.135B	£206.90
	250/125*		1	904.250125.135B	£206.90
	250/160*		1	904.250160.135B	£227.61
	250/200*		1	904.250200.135B	£227.61
	315/110*		1	904.315110.135B	£362.11
	315/125*		1	904.315125.135B	£362.11
	315/160*		1	904.315160.135B	£362.11
	315/200*		1	904.315200.135B	£382.79
	315/250*		1	904.315250.135B	£382.79

*Welded



HDPE 60° double Y branch

	50/40		25	906.5040.60B	£7.60
	63/50		25	906.6350.60B	£12.99
	110/110		10	906.110.60B	£19.64

HDPE 45° double reducing branch

	110/40		10	906.11040.135B	£17.76
	110/50		10	906.11050.135B	£20.24
	110/110		8	906.110.135B	£22.74

HDPE 88° swept branch

	56/56		40	904.56.92B	£10.59
	110/110		18	904.110.92B	£13.47

UNIQUE

HDPE 92° swept entry bossed branch

	Fabrication only*			
	5 Bosses. Bosses are butt weld only.			
110/110/56		17	904.110.925B	POA

* Contact our Advantage team for further information on 01622 795200

HDPE 88° single boss branch

	110/90		120	904.11090.12B	£62.13
--	--------	---	-----	---------------	--------

HDPE 88° double branch







	110		6	906.110.92B	£30.97
--	-----	---	---	-------------	--------

HDPE 90° 4 way branch

	110/56		8	920.110.56B	£35.66
	160/56		15	920.160.56B	£62.05

Prices shown are for one item excluding VAT

Branches

	Size mm		Pack Quantity	Code	Price Each
	HDPE 88° corner boss branch				
	110		9	906.11090.12B	£77.71
	HDPE 88° corner branch				
	110		12	906.11090.92B	£46.56
	HDPE 88° 3 way corner branch				
	110		75	906.11093.92B	£62.13

Prices shown are for one item excluding VAT

NEW UNIQUE HDPE MANIFOLD

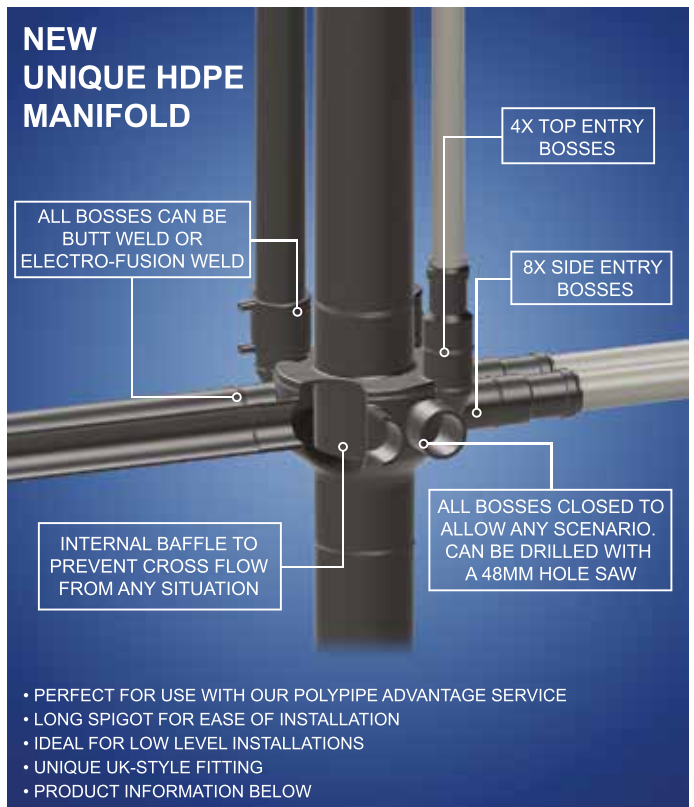





- PERFECT FOR USE WITH OUR POLYPIPE ADVANTAGE SERVICE
- LONG SPIGOT FOR EASE OF INSTALLATION
- IDEAL FOR LOW LEVEL INSTALLATIONS
- UNIQUE UK-STYLE FITTING
- PRODUCT INFORMATION BELOW

NEW Manifolds

	Size mm		Pack Quantity	Code	Price Each
	HDPE low level manifold				
	110		5	919.110.56B	£77.15

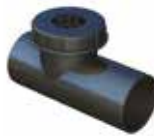
Prices shown are for one item excluding VAT



Reducers					
	Size mm	Pack Quantity	Code	Price Each	
HDPE concentric reducer					
	50/40	50	924.5040B	£2.73	
	56/50	150	924.5650B	£2.98	
	63/40	150	924.6340B	£2.98	
	63/50	50	924.6350B	£2.98	
	63/56	50	924.6356B	£2.98	
	75/40	50	924.7540B	£3.49	
	75/50	50	924.7550B	£3.49	
	75/56	50	924.7556B	£3.49	
	75/63	50	924.7563B	£3.49	
	90/40	30	924.9040B	£4.47	
	90/50	30	924.9050B	£4.47	
	90/56	30	924.9056B	£4.47	
	90/63	25	924.9063B	£4.47	
	90/75	25	924.9075B	£4.47	
	110/40	30	924.11040B	£5.48	
	110/50	30	924.11050B	£5.48	
	110/56*	60	924.11056B	£5.48	
	110/63	30	924.11063B	£5.48	
	110/75	30	924.11075B	£5.48	
	110/90	30	924.11090B	£5.48	
	125/50	20	924.12550B	£8.70	
	125/63	20	924.12563B	£8.70	
	125/75	20	924.12575B	£8.70	
	125/90	20	924.12590B	£8.70	
	125/110	20	924.125110B	£8.70	
	160/110*	1	924.160110B	£9.74	
	200/160	1	924.200160B	£61.97	
	HDPE eccentric reducer				
		50/40	50	923.5040B	£3.22
		56/40*	180	923.5640B	£2.57
56/50*		30	923.5650B	£3.49	
63/40		30	923.6340B	£3.73	
63/50		60	923.6350B	£3.73	
63/56		30	923.6356B	£3.73	
75/40		30	923.7540B	£4.25	
75/50		30	923.7550B	£4.25	
75/56*		45	923.7556B	£4.25	
75/63		30	923.7563B	£4.25	
	90/40	30	923.9040B	£4.26	
	90/50	30	923.9050B	£5.71	
	90/56	25	923.9056B	£5.71	
	90/63	25	923.9063B	£5.71	
	90/75	25	923.9075B	£5.71	
	110/40	25	923.11040B	£6.21	
	110/50	25	923.11050B	£6.21	
	110/56*	25	923.11056B	£6.21	
	110/63	25	923.110.63B	£6.21	
	110/75*	25	923.11075B	£6.21	
	110/90	25	923.11090B	£6.21	
	125/50	10	923.12550B	£9.94	
	125/56	10	923.12556B	£11.17	
	125/63	10	923.12563B	£11.17	
	125/75	10	923.12575B	£11.17	
	125/90	10	923.12590B	£11.17	
	125/110	10	923.125110B	£11.17	
	160/110*	10	923.160110B	£13.66	
	160/125	10	923.160125B	£13.66	

Reducers				
	Size mm	Pack Quantity	Code	Price Each
HDPE long eccentric reducer				
	160/110	5	923.160110LB	£74.45
	160/125	5	923.160125LB	£74.45
	200/110	8	923.200110LB	£99.24
	200/125	1	923.200125LB	£99.24
	200/160	1	923.200160LB	£99.24
	250/200	1	923.250200LB	£161.31
	315/200	1	923.315200LB	£223.31
315/250	1	923.315250LB	£223.31	
Prices shown are for one item excluding VAT				
Access				
	Size mm	Pack Quantity	Code	Price Each
HDPE 90° access pipe with screw cap				
	50	40	938.50.90B	£24.38
	56	20	938.56.90B	£24.80
	63	25	938.63.90B	£24.80
	75	30	938.75.90B	£26.87
	90	10	938.90.90B	£35.15
	110*	8	938.110.90B	£37.22
	125	5	938.125.90B	£44.43
	160	54	938.160.90B	£87.71
	200	1	938.200.90B	£144.82
	250	1	938.250.90B	£186.22
315	1	938.315.90B	£224.93	
* New unique bung design for improved flow.				
HDPE 45° access pipe with screw cap				
	110/110	1	938.110.135B	£35.74
	125/110	1	938.125.135B	£38.87
	160/110	1	938.160.135B	£87.54
HDPE short end cap with seal				
	110	10	9938.110B	£8.11
	HDPE screwed end cap			
	40	40	936.40B	£7.27
	50	40	936.50B	£7.43
	56	30	936.56B	£8.03
	63	20	936.63B	£11.14
	75	30	936.75B	£17.36
	90	20	936.90B	£19.83
	110*	20	936.110B	£23.57
* Includes bung.				
HDPE end cap with seal				
	56	10	9936.56B	£7.57
	110*	20	9936.110B	£19.36
* Includes bung.				
HDPE short screwed cap				
	Butt weld only			
	110	15	935.110B	£11.28

Prices shown are for one item excluding VAT

Prices shown are for one item excluding VAT

Access

	Size mm	Pack Quantity	Code	Price Each
HDPE threaded union				
	50	50	9122.50B	£3.59
	56	10	9122.56B	£3.77
	63	10	9122.63B	£3.77
	75	15	9122.75B	£5.96
	90	10	9122.90B	£9.36
	110	100	9122.110B	£9.55
HDPE nut				
	50	10	9120.50B	£4.31
	56	10	9120.56B	£4.87
	63	10	9120.63B	£4.87
	75	10	9120.75B	£7.75
	110	10	9120.110B	£11.88
HDPE threaded coupling				
	40	40	912.40B	£6.34
	50	40	912.50B	£6.85
	56	25	912.56B	£6.85
	56/63	25	912.5663B	£10.79
	63	25	912.63B	£16.15
	75	20	912.75B	£19.21
	90	15	912.90B	£20.83
110	15	912.110B	£24.57	





Prices shown are for one item excluding VAT

Blank Ends



	Size mm	Pack Quantity	Code	Price Each
HDPE blank ends				
Butt weld only up to 160mm.				
	40	100	930.40B	£3.06
	50	250	930.50B	£2.61
	56	250	930.56B	£2.61
	63	50	930.63B	£2.61
	75	30	930.75B	£2.61
	90	20	930.90B	£3.30
	110	40	930.110B	£6.18
125	30	930.125B	£7.76	
HDPE end cap				
	160	20	930.160B	£24.82
	200	15	930.200B	£35.16
	250	1	930.250B	£45.53
	315	1	930.315B	£51.74
wz				
	50	40	980.50B	£18.59
	56	1	980.56B	£18.59
	63	1	980.63B	£20.68
	75	1	980.75B	£25.77
	90	1	980.90B	£26.83
	110	20	980.110B	£28.47
	125	6	980.125B	£37.76
	160	10	980.160B	£48.64
	200	4	980.200B	£93.13
	250	5	980.250B	£161.38
	315	6	980.315B	£275.19

Prices shown are for one item excluding VAT

Blank Ends

	Size mm	Pack Quantity	Code	Price Each
Galvanised bolt with washer for flange				
	M16x90 (50-56 flange)	1(4pcs)	984.1650B	£10.37
	M16x100 (63-75 flange)	1(4pcs)	984.1663B	£12.41
	M16x100 (90 flange)	1(8pcs)	984.1690B	£22.77
	M16x110 (110-140 flange)	1(8pcs)	984.16110B	£26.90
	M20x110 (160 flange)	1(8pcs)	984.20160B	£39.34
	M20x130 (200-315 flange)	1(12pcs)	984.20250B	£72.42
Rubber flange seal				
	50	1	982.50B	£3.07
	56	1	982.56B	£4.12
	63	1	982.63B	£4.12
	75	1	982.75B	£4.26
	90	150	982.90B	£7.17
	110	1	982.110B	£8.27
	125	10	982.125B	£8.27
	160	1	982.160B	£9.84
	200	30	982.200B	£11.89
	250	1	982.250B	£20.67
	315	1	982.315B	£26.87
Painted aluminium backing ring				
	50	1	981.50B	£26.83
	56	1	981.56B	£28.87
	63	1	981.63B	£30.94
	75	1	981.75B	£35.08
	90	1	981.90B	£37.14
	110	1	981.110B	£41.28
	125	1	981.125B	£49.56
	160	1	981.160B	£72.34
	200	5	981.200B	£103.38
	250	1	981.250B	£150.96
	315	1	981.315B	£206.85
Painted aluminium blank flange				
	50	1	983.50B	£61.02
	56	1	983.56B	£44.68
	63	1	983.63B	£44.68
	75	1	983.75B	£47.14
	90	1	983.90B	£62.05
	110	1	983.110B	£74.45
	125	1	983.125B	£79.65
	160	1	983.160B	£124.04
	200	8	983.200B	£161.38
	250	1	983.250B	£223.46
	315	1	983.315B	£413.85







Prices shown are for one item excluding VAT

Utilities				
	Size mm	Pack Quantity	Code	Price Each
HDPE WC pan connector - white				
	90	10	925.90W	£29.97
	110	10	925.110W	£30.93
HDPE WC pan connector with cap				
	90	20	925.90B	£22.50
	110	10	925.110B	£22.50
HDPE long WC pan connector with seal				
	90 (length 200mm)	10	925L.90B	£28.80
	90 (length 300mm)	10	925XL.90B	£30.08
HDPE straight WC pan connector with seal and cap				
	90/100	10	999.90100.00B	£35.98
	90/100	10	998.90100.00B	£46.79
HDPE double WC pan connector with 1 lip seals and caps				
	90/110	5	929.90110.90DB	£84.58
	110/110	5	929.110.90DB	£84.58
HDPE bend for wall hung pan with 1 lip seal and cap, left				
	110/110	5	949.110LB	£48.61
	90/90	5	949.90LB	£44.98
	110/90	5	949.11090LB	£48.61
HDPE bend for wall hung pan with 1 lip seal and cap, right				
	110/110	5	949.110RB	£48.61
	90/90	5	949.90RB	£44.98
	110/90	5	949.11090RB	£48.61
HDPE WC pan connectors				
	110/110	5	949.110DB	£124.04
	110/90	5	949.11090DB	£124.04
HDPE seal for WC sleeves and extended bends				
	115	30	9129.125B	£6.20

Prices shown are for one item excluding VAT

Utilities				
	Size mm	Pack Quantity	Code	Price Each
HDPE connector for wall hung pan with seal & white covering				
	90/44	10	925.9044B	£47.14
	110/44	10	925.11044B	£26.99
HDPE WC bend for hanging pan with seal and cap				
	90/90	10	999.90.90B	£42.25
	110/110	10	999.110.90B	£42.25
HDPE trap with seal and cap				
	110	5	9631.110.0B	£53.99
	110 (45° tail)	5	9631.110.45B	£53.99
	110 (90° tail)	5	9631.110.90B	£53.99
HDPE WC connector for PVC with ring seal				
	100	10	925.100B	£28.80
HDPE extended WC pan connector with cap				
	90	20	993.90B	£9.91
	100	20	993.100B	£10.26
HDPE extended floor pan connector with 2 seals				
	110	10	993.110DB	£30.59
HDPE universal trap, vertical inlet and horizontal outlet				
	63	1	931.63B	£46.79
	75	1	931.75B	£101.84
	90	1	931.90B	£115.52
	110	4	931.110B	£131.86
HDPE trap, vertical inlet and horizontal outlet				
	40/40	30	931.4040B	£39.59
	40/50	80	931.4050B	£52.18
	40/56	10	931.4056B	£52.19
	50/50	10	931.5050B	£39.59
	50/56	10	931.5056B	£52.19







Prices shown are for one item excluding VAT



Utilities				
	Size mm	Pack Quantity	Code	Price Each
HDPE trap - vertical inlet and outlet				
	40/40	50	932.4040B	£52.19
	40/50	10	932.4050B	£52.19
	40/56	10	932.4056B	£52.19
	50/50	10	932.5050B	£52.19
	50/56	10	932.5056B	£52.19
HDPE trap - horizontal inlet and outlet				
	40/40	15	945.4040B	£52.19
	40/50	10	945.4050B	£52.19
	50/50	10	945.5050B	£64.78
HDPE washing machine connector				
	50	20	933.50B	£13.49
HDPE fitting with nut - *brass *plastic				
	40mm/1¼"*	50	918.40.125BN	£7.56
	40mm/1½"*	50	918.40.15BN	£7.21
	50mm/1¼"*	40	918.50.125BN	£6.85
	50mm/1½"*	40	918.50.15BN	£7.57
	40mm/1¼"•	40	918.40.125PN	£6.29
	40mm/1½"•	40	918.40.15PN	£6.31
	50mm/1¼"•	30	918.50.125PN	£6.29
	50mm/1½"•	80	918.50.15PN	£6.66
HDPE extended fitting with nut - *brass *plastic				
	40mm/1¼"*	20	918.40.125EB	£11.33
	40mm/1½"*	20	918.40.15EBN	£11.34
	50mm/1¼"*	20	918.50.125EBN	£13.48
	50mm/1½"*	20	918.50.15EBN	£13.49
	40mm/1¼"•	20	918.40.125EPN	£10.24
	40mm/1½"•	20	918.40.15EPN	£10.26
	50mm/1¼"•	20	918.50.125EPN	£11.69
	50mm/1½"•	20	918.50.15EPN	£11.69
	HDPE female iron			
	40mm x ½"	40	916.40.05B	£34.22
	40mm x ¾"	20	916.40.075B	£34.22
	40mm x 1"	20	916.40.1B	£34.22
	50mm x ½"	20	916.50.05B	£50.37
	50mm x ¾"	20	916.50.075B	£50.37
	50mm x 1"	20	916.50.1B	£50.37
	50mm x 1¼"	30	916.50.125B	£50.37
	50mm x 1½"	50	916.50.15B	£50.37
	56mm x 2"	50	916.56.2B	£61.19
	63mm x 2"	30	916.63.2B	£47.71
75mm x 2½"	5	916.75.25B	£57.93	

Prices shown are for one item excluding VAT

Utilities				
	Size mm	Pack Quantity	Code	Price Each
HDPE male iron				
	50mm x 1¼"	10	917.50.125B	£50.37
	50mm x 1½"	50	917.50.15B	£50.37
	56mm x 2"	100	917.56.2B	£61.19
	63mm x 2"	10	917.63.2B	£47.49
	75mm x 2½"	5	917.75.25B	£60.01
HDPE threaded fitting with brass nipple				
	40mm/½" x 15	40	936.40.05NB	£39.59
	40mm/¾" x 18	10	936.40.075NB	£39.59
	50mm/½" x 15	5	936.50.05NB	£39.59
	50mm/¾" x 18	5	936.50.075NB	£39.59
	50mm/1" x 22	5	936.50.1NB	£39.59
HDPE bend with nut - *brass *plastic				
	40mm/1¼"*	20	918.40.125.90BN	£6.65
	40mm/1½"*	20	918.40.15.90BN	£6.85
	40mm/1½"•	20	918.40.15.90PN	£6.29
HDPE reducing bend with nut - *brass *plastic				
	40/50mm/1¼"*	20	918.4050.125.90BN	£6.65
	40/50mm/1½"*	25	918.4050.15.90BN	£6.85
	40/50mm/1¼"•	20	918.4050.125.90PN	£5.96
	40/50mm/1½"•	20	918.4050.15.90PN	£6.48
HDPE sleeve				
	40/46	50	917.4046B	£2.35
	50/46	50	917.5046B	£2.40
	50/58	50	917.5058B	£2.71
	56/46	50	917.5646B	£2.71
	56/58	50	917.5658B	£2.71
HDPE gasket				
	46/36-40	150	917.4636.908B	£0.78
	58/36-40	100	917.5836.908B	£1.62
	58/47-50	100	917.5847.908B	£1.62
HDPE spigot bend with cap				
	40/46	40	917.4046.90B	£2.71
	50/46	40	917.5046.90B	£2.71
	50/58	20	917.5058.90B	£3.16
	56/46	20	917.5646.90B	£3.16
	56/58	20	917.5658.90B	£3.16

Prices shown are for one item excluding VAT

Spares				
	Size mm	Pack Quantity	Code	Price Each
HDPE protective cap for socket				
	40	40	9130.40B	£0.63
	50	150	9130.50B	£0.63
	56	160	9130.56B	£0.63
	63	30	9130.63B	£0.63
	75	30	9130.75B	£0.64
	90	30	9130.90B	£0.78
	110	60	9130.110B	£0.89
	125	20	9130.125B	£0.89
	160	10	9130.160B	£1.62
200	5	9130.200B	£2.00	
HDPE ring				
Suitable for 912 HDPE threaded coupling.				
	50	10	9118.50B	£1.26
	56	10	9118.56B	£1.89
	63	10	9118.63B	£1.54
	75	10	9118.75B	£1.71
	90	10	9118.90B	£2.07
	110	10	9118.110B	£2.07
HDPE ring seal				
Suitable for 912 HDPE threaded coupling.				
	50	10	9119.50B	£0.78
	56	50	9119.56B	£1.18
	63	10	9119.63B	£1.18
	75	10	9119.75B	£1.71
	90	10	9119.90B	£1.71
	110	20	9119.110B	£1.71
	HDPE 1 lip seal for sockets			
Suitable for 927 HDPE ring seal adaptors.				
	90	20	927.90.908B	£0.63
	100	20	927.100.908B	£0.63
	110	20	927.110.908B	£0.63
	125	20	927.125.908B	£1.09
	160	20	927.160.908B	£1.44
	200	20	927.200.908B	£2.52
	250	1	927.250.908B	£5.04
	315	1	927.315.908B	£6.66
	HDPE O ring for adaptors - PVC			
Suitable for 9113.110100B PVC adaptor.				
	100	20	9113.908B	£0.39
HDPE O ring for sockets				
	40	20	9116.40B	£0.33
	50	20	9116.50B	£0.39
	63	20	9116.63B	£0.59
	75	20	9116.75B	£0.59
	90	20	9116.90B	£1.00
	110	20	9116.110B	£1.00
	125	20	9116.125B	£1.62
	160	20	9116.160B	£2.52

Spares					
	Size mm	Pack Quantity	Code	Price Each	
HDPE seal for expansion sockets					
Suitable for 911 HDPE expansion joint.					
	40	20	911.40.908B	£0.89	
	50	20	911.50.908B	£1.00	
	56	20	911.56.908B	£1.54	
	63	20	911.63.908B	£2.00	
	75	20	911.75.908B	£2.00	
	90	20	911.90.908B	£2.35	
	110	50	911.110.908B	£2.52	
	125	10	911.125.908B	£2.71	
	160	10	911.160.908B	£3.43	
	200	10	911.200.908B	£8.64	
Prices shown are for one item excluding VAT					
Firetraps					
Firetrap sleeve					
	17 x 300		1925.17	£35.95	
	21 x 300		1925.21	£37.24	
	27 x 300		1925.27	£39.99	
	34 x 300		1925.34	£40.18	
	42 x 300		1925.42	£44.12	
	48 x 300		1925.48	£45.53	
	54 x 300	8	1925.54	£46.23	
	60 x 300†	8	1925.60	£46.91	
	67 x 300	16	1925.67	£48.26	
	76 x 300†	6	1925.76	£51.31	
	89 x 300		1925.89	£57.17	
	102 x 300		1925.102	£61.66	
	108 x 300		1925.108	£62.00	
	114 x 300†	9	1925.114	£65.39	
	127 x 300		1925.127	£70.65	
	134 x 300		1925.134	£72.48	
	140 x 300		1925.140	£74.03	
	159 x 300		1925.159	£79.25	
	169 x 300†	4	1925.169	£82.70	
†Held in stock by Polypipe					
Note: As a Firetrap product a different discount structure applies.					
Firetrap Collar					
	40	Red 5/50	1625.40R	£15.74	
	55	Red 5/50	1625.55R	£16.58	
	63	Red 5/25	1625.63R	£19.21	
	75	Red 5/40	1625.75R	£21.07	
	82	Red 5/40	1625.82R	£17.97	
	90	Red 5/10	1625.90R	£18.80	
	110	Red 5/40	1625.110R	£22.41	
	125	Red 5/10	1625.125R	£23.48	
	160	Red 5/20	1625.160R	£35.29	
	200	Red 5/15	1625.200R	£114.74	
	250	Red 5/10	1625.250R	£240.14	
	315	Red 5/10	1625.315R	£693.72	
	Note: As a Firetrap product a different discount structure applies.				

Prices shown are for one item excluding VAT

Prices shown are for one item excluding VAT

NEW 2 IN 1 BRACKET, WORKS AS A GUIDE OR ANCHOR

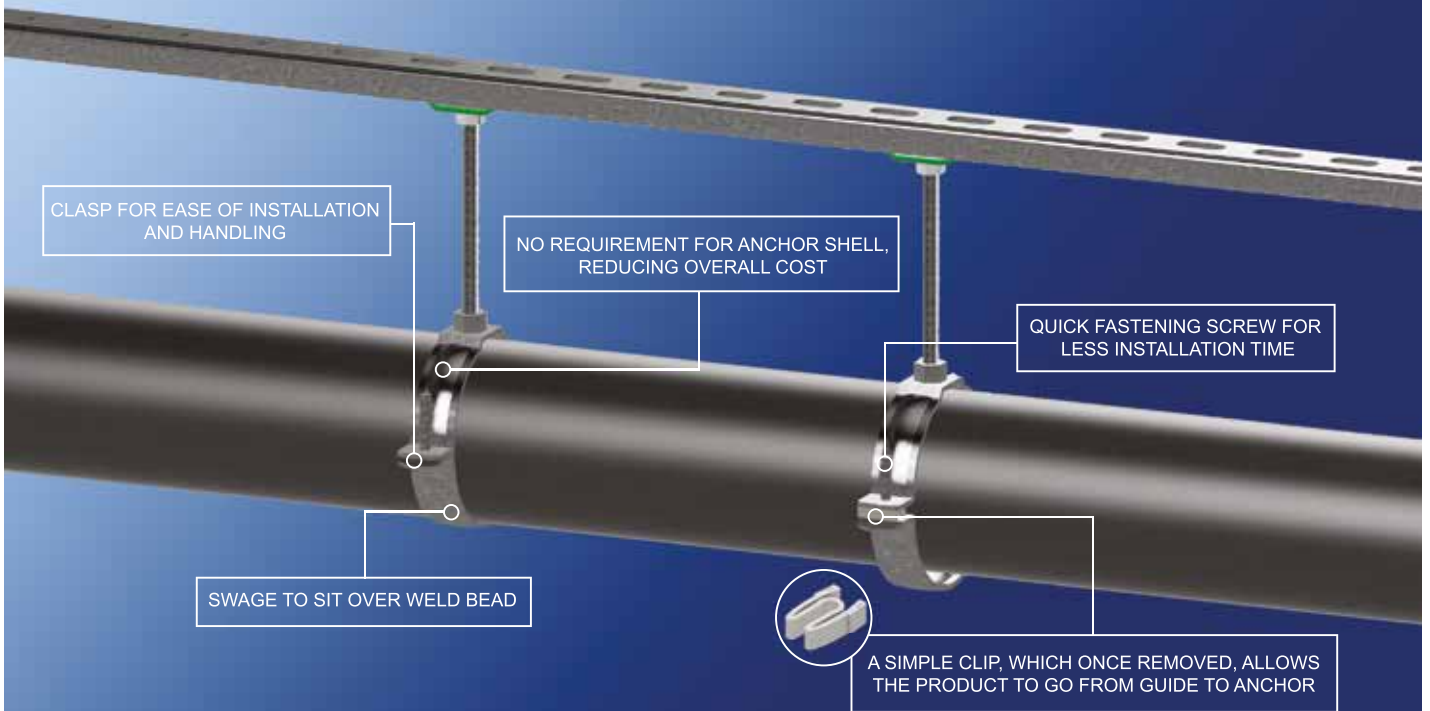

- MULTI-FUNCTIONAL PRODUCT TO STORE LESS PRODUCT. RESULTING IN LARGE REDUCTION OF SKU.
- INSTALL WITH OUR NEW FIXING BACK PLATE, CHANGED TO A RECTANGULAR SHAPE, FOR EASY INSTALLATION.
- PRODUCT INFORMATION BELOW.

Anchors and brackets

	Size mm	Pack Quantity	Code	Price Each
NEW	Anchor / Guide Bracket			
	Guide bracket performs as an anchor with removal of the plastic clips.			
	40mm x M8	50	9140.40B	£3.59
	50mm x M8	50	9140.50B	£4.96
	56mm x M8	50	9140.56B	£5.08
	63mm x M8	50	9140.63B	£5.15
	75mm x M10	25	9140.75B	£5.36
	90mm x M10	25	9140.90B	£5.79
	110mm x M10	25	9140.110B	£6.20
	125mm x M10	25	9140.125B	£6.62
	160mm x M10	25	9140.160B	£7.36
	200mm x M10	25	9140.200B	£26.83
	250mm x M10	10	9140.250B	£27.14
	315mm x M10	10	9140.315B	£31.66

M16 bracket





	200mm x M16	15	9149.200B	£40.92
	250mm x M16	2	9149.250B	£40.92
	315mm x M16	2	9149.315B	£41.92

NEW Acoustic pipe bracket

	110	15	9140.110R	£15.54
	160	1	9140.160R	£20.83

Prices shown are for one item excluding VAT

Anchors and brackets

	Size mm	Pack Quantity	Code	Price Each
Mounting plate				
	M10	100	9148.10B	£4.70
	G1"	25	9148.25B	£5.80
Rubber flat seal				
	40mm x 1/4"	10	918.40.908B	£0.22
	40mm x 1/2"	10	918.40.918B	£0.22
Threaded bar				
	M10 x 1 metre	1	9147B	£2.71
	M16 x 1 metre	1	9148B	£8.79
Rubber insert strip				
	For acoustic brackets 40mm x 10m	2	9104.40B	£35.56
Anti vibration insert				
	For acoustic brackets 30mm x 30 (58mm-314mm)	1	9105.30B	£113.83

Prices shown are for one item excluding VAT

Electrofusion Coupling



Available in sizes 40 - 315mm

Connection properties:

Non-removable

Tension resistant

Use

This form of jointing is suitable for on-site welding, additional installations, repair work and modifications.

The pressure required for welding is obtained from the shrinking effect of the sleeve upon

heating and is distributed equally over the entire weld.

This shrinkage has a compensating effect on pipe diameter measurement tolerances.

By removing the central stop ring, the electrical sleeves can be made to slide to enable system modifications and repairs.

The electrical resistance wires will not corrode as they are protected by HDPE after welding.



Pipe scraper



Terrain FUZE Box

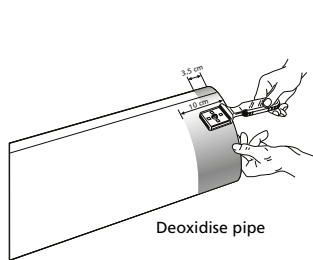

Deoxidise pipe

Cut the pipe squarely, dry, clean and scrape the welding surfaces. The surface must remain clean and dry during the whole welding process, therefore do not touch with your hands.

The length of pipe to be scraped with diameters ranging from 40 - 160mm is 35mm.

The length of pipe to be scraped with diameters 200, 250 and 300mm is 100mm.

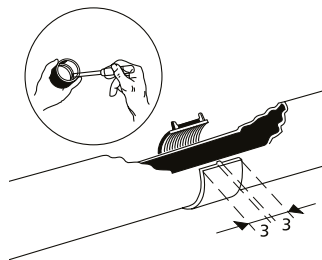

Insert pipe or fitting into sleeve coupling. If the stop ring in the sleeve needs to be removed, mark the depth at 30mm.

Electrofusion Machines

Description	Quantity	Product Code	Price Each
FUZE electrofusion welding machine 40-315mm			
40 to 315mm	1	9000.40315.110V	£1,864.97
Replacement leads			
<100mm (Yellow)	1	AW00-2003	£118.41
160mm> (Blue)	1	AW00-2004	£133.22
HDPE pipe scraper			
	10	9507T	£50.37
Pipe cutter			
40 to 63mm	1	9500.663T	£212.34
50 to 140mm	1	9500.50140T	£305.91
100 to 160mm	1	9500.100160T	£341.89
Spare blades			
40 to 63mm	10	9501.63T	£44.98
HDPE pencils			
	1 (12Pcs.)	9508T	£83.67
HDPE knife			
	1 (12Pcs.)	9504T	£156.56
Bevelling tool			
40 to 250mm	1	9502.40250T	£415.67
32 to 160mm	1	9502.32160T	£269.91

Universal Electrofusion Machine spares

Description	Cables	Product Code	Price Each
40-160mm	Yellow	HDC464334	£354.10
200-315mm	Blue	HDC464335	£354.10

Expansion Socket with Ring Seal

Available in sizes 40 - 315mm

Connection properties:

Non-removable

Non-tension resistant



Use

Expansion sockets can be used in underground pipe systems as normal push-fit fittings but must be provided on vertical stacks running from floor to floor and for rainwater pipes both inside and outside the building.

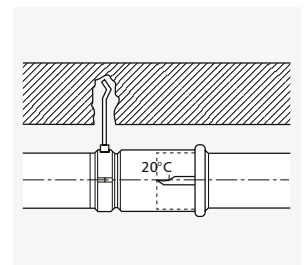

Horizontal assembly (e.g. at an ambient temperature of 20°C).

Terrain

Index

Code	Pack Qty	Price	Page
HDPE Fittings			
9120.56B	10	£4.87	30
9120.63B	10	£4.87	30
9120.75B	10	£7.75	30
9122.110B	100	£9.55	30
9122.50B	50	£3.59	30
9122.56B	10	£3.77	30
9122.63B	10	£3.77	30
9122.75B	15	£5.96	30
9122.90B	10	£9.36	30
9129.125B	30	£6.20	31
9130.110B	60	£0.89	33
9130.125B	20	£0.89	33
9130.160B	10	£1.62	33
9130.200B	5	£2.00	33
9130.40B	40	£0.63	33
9130.50B	150	£0.63	33
9130.56B	160	£0.63	33
9130.63B	30	£0.63	33
9130.75B	30	£0.64	33
9130.90B	30	£0.78	33
9140.110B	25	£6.20	34
9140.110R	15	£15.54	34
9140.125B	25	£6.62	34
9140.160B	25	£7.36	34
9140.160R	1	£20.83	34
9140.200B	25	£26.83	34
9140.250B	10	£27.14	34
9140.315B	10	£31.66	34
9140.40B	50	£3.59	34
9140.50B	50	£4.96	34
9140.56B	50	£5.08	34
9140.63B	50	£5.15	34
9140.75B	25	£5.36	34
9140.90B	25	£5.79	34
9148.10B	100	£4.70	34
9148.25B	25	£5.80	34
9149.200B	15	£40.92	34
9149.250B	2	£40.92	34
9149.315B	2	£41.92	34
9631.110.0B	5	£53.99	31
9631.110.45B	5	£53.99	31
9631.110.90B	5	£53.99	31
9936.110B	20	£19.36	29
9936.56B	10	£7.57	29
9938.110B	10	£8.11	29
910P.110B	1	£54.77	25
910P.160B	5	£197.95	25
910P.200B	1	£251.92	25
910P.250B	1	£377.88	25
910P.315B	1	£521.83	25
911S.110B	16	£101.79	25
911S.160B	10	£197.95	25
911S.200B	1	£269.91	25
911S.250B	1	£377.88	25
911S.315B	1	£521.83	25
9147B	1	£2.71	34
9148B	1	£8.79	34
925L.90B	10	£28.80	31
925XL.90B	10	£30.08	31

Terrain P.A.P.A.® and Pleura Vent System

- Replaces extensive ventilation pipework, saving costs in material and installation.
- Allows more flexibility in the layout and design of internal drainage systems for engineers, architects and design professionals.
- Offers a point-of-need solution that quickly responds to transient air fluctuations.

Terrain Pleura 50

The Terrain Pleura 50 air regulator provides ventilation to branch pipework. It is generally installed on the pipe behind the appliance trap.

The Terrain Pleura 50 opens and admits fresh air into the branch pipe when the negative (suction) pressure occurs from an appliance discharging into the pipework system. This equalises the ambient air pressure within the pipework and protects the trap seal.

When the flow stops and the internal ambient air pressure in the pipework balances, the Terrain Pleura 50 closes by gravity and prevents foul air entering the built environment.

Terrain Pleura 100



The Terrain Pleura 100 air regulator can be fitted on to the top of a foul or waste stack, or at the end of long low gradient branch drains, to provide ventilation.



The Terrain Pleura 100 opens and admits fresh air under condition of reduced pressure in the discharge pipes and prevents trapped water seals being drawn. As the internal ambient air pressure in the pipework balances, the Terrain Pleura 100 closes by gravity and prevents foul air entering the built environment.

Terrain P.A.P.A.

The Terrain P.A.P.A. is a positive air pressure attenuator, designed to mitigate the affects of positive air fluctuations in the drainage pipework system. As water descends down the drainage stack it creates a negative pressure; if that flow is interrupted or is approaching a change of direction, the negative pressure changes to a positive pressure and moves up the pipe. This low amplitude air wave travels typically at 320m/s, the speed of sound. As the positive air fluctuation approaches the branch-off point for the Terrain P.A.P.A., the bladder within the unit reacts very quickly, within 0.2 seconds, and starts to expand; this creates a pressure differential at the branch-off point. The branch to the Terrain P.A.P.A. then becomes the path of least resistance and the majority of the positive air pressure is absorbed within the unit.

As the ambient air pressure within the pipework starts to equalise, the bladder slowly releases the small volume of air into the pipework system at only 12m/s which will have no effect on the trap seals.

Terrain P.A.P.A. and Pleura Vent System				
	Size mm	Pack Quantity	Code	Price Each
Terrain P.A.P.A. Valve				
	75-110	1	9300.4	£576.69
Terrain Pleura 100 Valve				
	75-110	1	9301.34	£117.67

Terrain P.A.P.A. and Pleura Vent System				
	Size mm	Pack Quantity	Code	Price Each
Terrain Pleura 50 Valve				
	32-63	1	9301.253	£51.22
Maxi Filtra Valve				
	75-110	1	9302.34	£74.41

Prices shown are for one item excluding VAT Note: Orders must be in pack quantity multiples

Prices shown are for one item excluding VAT Note: Orders must be in pack quantity multiples

Terrain dB12



Acoustic drainage system with superior performance

We all know how much noise water can make when it travels through a building and how intrusive this sound can be. In endeavouring to meet sound controls within Building Regulations, additional materials and labour are required, increasing the cost and time on site. Terrain dB12 is a complete acoustic drainage system designed to reduce the effect of noise.

Terrain dB12 multilayer drainage pipe with acoustic fittings creates a high quality durable and reliable system developed specifically to meet construction requirements for increased level of soundproofing, and ideally suitable for:

- Mixed development
- Hospitals
- Hotels
- Schools
- Commercial applications

Terrain dB12 combines the familiarity and advantages of standard ring seal soil systems, with a proven enhanced acoustic performance.

Vibration damping brackets ensure that the system minimises solid borne noise transmission.

The Benefits

- Proven noise reducing characteristics, tested to EN 14366/DIN 4109
- Flame retardant to B1 in compliance with DIN 4102
- Elevated impact resistance even at low temperatures
- Resistance to a wide range of chemical agents at high temperatures
- Push fit single lip Elastomeric seals
- Easy to install
- Complete with range of acoustically engineered fittings
- Fabrication is available for non standard products

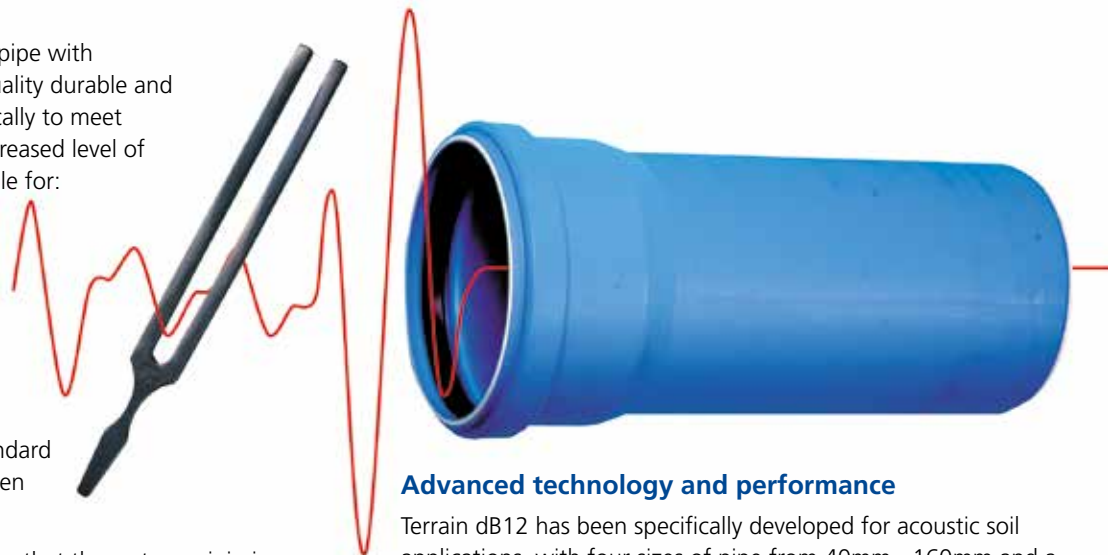

Advanced technology and performance

Terrain dB12 has been specifically developed for acoustic soil applications, with four sizes of pipe from 40mm - 160mm and a comprehensive range of fittings to provide a complete solution for acoustic management of soil pipes.

Terrain dB12 multilayer pipe and acoustic fittings have been tested to the most recent European accreditations for airborne and impact noise, at the highly respected Fraunhofer Institute in Stuttgart.

Terrain dB12 now available in 200 and 250mm
Please contact the Technical Department
for price and availability

Pipes

	Size mm	Pack Quantity	Code	Price Each
Single socket pipe				
	40 (3m)	30	AS650033PY	£20.54
	50 (3m)	30	AS650053PY	£18.76
	110 (3m)	15	AS650113PY	£53.16
	160 (3m)	10	AS650153PY	£112.20

Prices shown are for one item excluding VAT Note: Orders must be in pack quantity multiples

Fittings

	Size mm	Pack Quantity	Code	Price Each
Bend 15°				
	40	30	AS650411	£4.27
	50	20	AS650421	£5.55
	110	20	AS650451	£21.18
	160	1	AS650471	£46.01

Bend 30°				
	40	50	AS650413	£4.27
	50	20	AS650423	£5.55
	110	30	AS650453	£22.22
	160	1	AS650473	£47.30

Bend 45°				
	40	50	AS650415	£4.27
	50	90	AS650425	£5.55
	110	25	AS650455	£23.61
	160	4	AS650475	£48.99

Bend 67°				
	40	30	AS650417	£4.27
	50	20	AS650427	£5.55
	110	20	AS650457	£24.26

Bend 87°				
	40	100	AS650419	£4.27
	50	60	AS650429	£5.55
	110	20	AS650459	£24.79
	160	3	AS650479	£52.25

Branch 45°				
	40	10	AS650507	£9.80
	50	40	AS650513	£11.91
	110	10	AS650531	£40.30
	160	4	AS650543	£108.94

Prices shown are for one item excluding VAT Note: Orders must be in pack quantity multiples

Fittings

	Size mm	Pack Quantity	Code	Price Each
Branch 87°				
	40	30	AS650511	£9.37
	50	40	AS650517	£11.04
	110	15	AS650535	£72.67
	160	1	AS650547	£174.16

Reducing branch 45°				
	50/40	20	AS650557	£11.91
	110/40	15	AS650587	£26.61
	110/50	20	AS650593	£26.61
	160/110	5	AS650617	£78.92

Reducing branch 87°				
	50/40	25	AS650561	£11.04
	110/40	15	AS650591	£26.61
	110/50	20	AS650597	£26.61
	160/110	7	AS650621	£139.35

Double branch 45°				
	110	5	AS650655	£78.85

Eccentric reducer				
	50/40*	20	AS650705	£5.32
	110/40†	20	AS650717	£10.64
	110/50†	20	AS650719	£25.05
	160/110†	25	AS650731	£29.08







Double depth socket				
	40	60	AS650751	£7.13
	50	20	AS650753	£9.46
	110	15	AS650759	£11.35

Triple depth socket				
	110	15	AS650779	£19.30







Prices shown are for one item excluding VAT Note: Orders must be in pack quantity multiples

Terrain

Fittings

	Size mm	Pack Quantity	Code	Price Each	
Slip coupler					
	40	30	AS650803	£6.20	
	50	20	AS650805	£7.03	
	110	30	AS650811	£14.97	
	160	1	AS650815	£42.14	
Double socket					
	40	30	AS650853	£6.21	
	50	30	AS650855	£6.61	
	110	30	AS650861	£21.79	
	160	10	AS650865	£40.47	
Access with cap					
	50	20	AS650901	£15.55	
	110	15	AS650907	£49.91	
	160	5	AS650911	£113.63	
Socket plug					
	40	40	AS650951	£4.27	
	50	40	AS650953	£6.43	
	110	60	AS650959	£14.43	
	160	6	AS650963	£51.15	
Spigot bend with cap for boss adaptor					
	40	46	20	AS650972	£10.20
	40	53.5	20	AS650973	£10.20
	50	53.5	20	AS650974	£10.20
	50	60	20	AS650975	£10.20
Straight fitting with cap for boss adaptor					
	40	46	20	AS650982	£10.20
	40	50	20	AS650983	£10.20
	40	53.5	20	AS650984	£10.20
	50	53.5	20	AS650985	£10.20
Push fit boss adaptor					
	For use with Spigot Bend and Straight fitting above				
	46	24-32	100	AS334003	£3.24
	46	36-40	100	AS334005	£3.24
	50	36-40	50	AS523011	£3.46
	53-5	24-32	50	AS523015	£3.46
53-5	36-40	50	AS523017	£3.46	

PVC Fittings

	Size mm	Pack Quantity	Code	Price Each
Double equal branch				
	110	2	AS659995	£134.85
	For use with Terrain 117 boss adaptors on page 11			
Single branch				
	110	8	AS659996	£72.67
	For use with Terrain 117 boss adaptors on page 11			
Four way boss				
	110	15	AS659997	£29.63
	For use with Terrain 117 boss adaptors on page 11			
Corner boss branch				
	110	6	AS659998	£265.95
Universal soil manifold				
	110	5	AS659999	£70.00
dB12 to PVC adaptor				
	40mm to 1½"	1	6789/DVW	£6.07
	50mm to 2"	1	6790/DVW	£6.01

Prices shown are for one item excluding VAT Note: Orders must be in pack quantity multiples







Brackets and Accessories

	Size mm	Pack Quantity	Code	Price Each	
Firetrap Collar					
	40	♥ ♣ ♠ Red	5/50	1625.40R	£15.74
	55	♥ ♣ ♠ Red	5/50	1625.55R	£16.58
	63	♥ ♣ ♠ Red	5/25	1625.63R	£19.21
	75	♥ ♣ ♠ Red	5/40	1625.75R	£21.07
	82	♥ ♣ ♠ Red	5/40	1625.82R	£17.97
	90	♥ ♣ ♠ Red	5/10	1625.90R	£18.80
	110	♥ ♣ ♠ Red	5/40	1625.110R	£22.41
	125	♥ ♣ ♠ Red	5/10	1625.125R	£23.48
	160	♥ ♣ ♠ Red	5/20	1625.160R	£35.29
	200	♥ ♣ ♠ Red	5/15	1625.200R	£114.74
	250	♥ ♣ ♠ Red	5/10	1625.250R	£240.14
	315	♥ ♣ ♠ Red	5/10	1625.315R	£693.72
Note: As a Firetrap product a different discount structure applies.					

Prices shown are for one item excluding VAT Note: Orders must be in pack quantity multiples

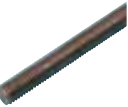
Prices shown are for one item excluding VAT Note: Orders must be in pack quantity multiples

Brackets and Accessories

	Size mm		Pack Quantity	Code	Price Each
Acoustic bracket G1/2"					
	50 G1/2"		25	AS252005	£9.60
	110 G1/2"		25	AS252011	£13.85
	160 G1/2"		25	AS252015	£15.94
Acoustic bracket M10					
	40 M10		100	AS3403043	£4.07
	50 M10		100	AS3403053	£4.74
	110 M10		100	AS3403114	£10.62
	160 M10		100	AS3423168	£17.17
Flange for wall fixing					
	70 G1/2"		100	AS398001	£5.97
	70 M10		100	AS398003	£4.83
Threaded rod					
	M10 x 1 metre		1	AS408001	£2.77
Pipe cutter					
	40-63 T2		1	9500.663T	£212.34
	50-140 T3		1	9500.50140T	£305.91
	100-160		1	9500.100160T	£341.89
Beveller					
	32-160		1	9502.32160T	£269.91
Protection cap for socket					
	40		40	AS503001	£2.62
	50		200	AS503003	£9.26
	110		60	AS503007	£12.09
	160		10	AS503011	£14.36
Single-lipped seal					
	40		50	AS391003	£1.88
	50		50	AS391005	£1.88
	110		20	AS391015	£1.88
	160		20	AS391019	£1.88

Prices shown are for one item excluding VAT Note: Orders must be in pack quantity multiples

Index

Code	Pack Qty	Price	Page
dB12 Pipe			
AS650033PY	30	£20.54	41
AS650053PY	30	£18.76	41
AS650113PY	15	£53.16	41
AS650153PY	10	£112.20	41
dB12 Fittings			
AS650411	30	£4.27	41
AS334003	100	£3.24	42
AS334005	100	£3.24	42
AS523011	50	£3.46	42
AS523015	50	£3.46	42
AS523017	50	£3.46	42
AS650413	50	£4.27	41
AS650415	50	£4.27	41
AS650417	30	£4.27	41
AS650419	100	£4.27	41
AS650421	20	£5.55	41
AS650423	20	£5.55	41
AS650425	90	£5.55	41
AS650427	20	£5.55	41
AS650429	60	£5.55	41
AS650451	20	£21.18	41
AS650453	30	£22.22	41
AS650455	25	£23.61	41
AS650457	20	£24.26	41
AS650459	20	£24.79	41
AS650471	1	£46.01	41
AS650473	1	£47.30	41
AS650475	4	£48.99	41
AS650479	3	£52.25	41
AS650507	10	£9.80	41
AS650511	30	£9.37	41
AS650513	40	£11.91	41
AS650517	40	£11.04	41
AS650531	10	£40.30	41
AS650535	15	£72.67	41
AS650543	4	£108.94	41
AS650547	1	£174.16	41
AS650557	20	£11.91	41
AS650561	25	£11.04	41
AS650587	15	£26.61	41
AS650591	15	£26.61	41
AS650593	20	£26.61	41
AS650597	20	£26.61	41
AS650617	5	£78.92	41
AS650621	7	£139.35	41
AS650655	5	£78.85	41
AS650705	20	£5.32	41
AS650717	20	£10.64	41
AS650719	20	£25.05	41
AS650731	25	£29.08	41
AS650751	60	£7.13	41
AS650753	20	£9.46	41
AS650759	15	£11.35	41
AS650779	15	£19.30	41
AS650803	30	£6.20	42
AS650805	20	£7.03	42
AS650811	30	£14.97	42
AS650815	1	£42.14	42
AS650853	30	£6.21	42
AS650855	30	£6.61	42
AS650861	30	£21.79	42
AS650865	10	£40.47	42
AS650901	20	£15.55	42
AS650907	15	£49.91	42
AS650911	5	£113.63	42
AS650951	40	£4.27	42
AS650953	40	£6.43	42
AS650959	60	£14.43	42
AS650963	6	£51.15	42

Index

Code	Pack Qty	Price	Page
AS650972	20	£10.20	42
AS650973	20	£10.20	42
AS650974	20	£10.20	42
AS650975	20	£10.20	42
AS650982	20	£10.20	42
AS650983	20	£10.20	42
AS650984	20	£10.20	42
AS650985	20	£10.20	42
AS659995	2	£134.85	42
AS659996	8	£72.67	42
AS659997	15	£29.63	42
AS659998	6	£265.95	42
AS659999	5	£70.00	42
6789/DVW	1	£6.07	42
6790/DVW	1	£6.01	42
dB12 Brackets and Accessories			
1625.110R	5/40	£22.41	42
1625.125R	5/10	£23.48	42
1625.160R	5/20	£35.29	42
1625.200R	5/15	£114.74	42
1625.250R	5/10	£240.14	42
1625.315R	5/10	£693.72	42
1625.40R	5/50	£15.74	42
1625.55R	5/50	£16.58	42
1625.63R	5/25	£19.21	42
1625.75R	5/40	£21.07	42
1625.82R	5/40	£17.97	42
1625.90R	5/10	£18.80	42
9500.100160T	1	£341.89	43
9500.50140T	1	£305.91	43
9500.663T	1	£212.34	43
9502.32160T	1	£269.91	43
AS252005	25	£9.60	43
AS252011	25	£13.85	43
AS252015	25	£15.94	43
AS3403043	100	£4.07	43
AS3403053	100	£4.74	43
AS3403114	100	£10.62	43
AS3423168	100	£17.17	43
AS391003	50	£1.88	43
AS391005	50	£1.88	43
AS391015	20	£1.88	43
AS391019	20	£1.88	43
AS398001	100	£5.97	43
AS398003	100	£4.83	43
AS408001	1	£2.77	43
AS503001	40	£2.62	43
AS503003	200	£9.26	43
AS503007	60	£12.09	43
AS503011	10	£14.36	43

Prices shown are for one item excluding VAT



MINIMAL DISRUPTION

MAXIMUM PROTECTION.

THE TERRAIN LIVE STACK REPLACEMENT
SERVICE WITH **FIRETRAP SLEEVES AND COLLARS**

Partnering with you, Polypipe delivers unique fabricated replacement drainage stack solution, featuring Terrain drainage systems; ready to install, ready when you are – and without having to move residents from their homes.

For complete peace of mind, they're also available with our Terrain Firetrap sleeves and collars, designed to go beyond today's fire regulations.

It's what you'd expect from a trusted product range and a company of innovators.



Terrain Siphonic Roof Drainage System



Terrain provides an advanced Siphonic Roof Drainage solution offering full compliance with BS 8490:2007 using Terrain FUZE BBA certified pipes and fittings. The Terrain Siphonic Roof Drainage system's self-cleaning, high velocity flow offers a quick and efficient way to remove large volumes of rainwater from roofs in a controlled manner. Designed to accommodate recent changes in storm patterns, as stipulated in BS EN 12056-3:2000 it uses siphonic principles to 'suck' the rainwater from the roof into small diameter pipes, creating a flow capacity up to ten times greater than that of an equivalent gravity-fed system.

Specially designed high flow siphonic roof drain eliminates air ingress to promote speedy priming

- Pipes run horizontally within building envelope
- Reduces underground drainage requirements
- Up to 45% cost saving overall
- Exceptionally accurate design software
- Easy routing of rainwater from roof to desired discharge location, making system an ideal partner for rainwater harvesting

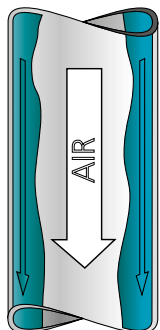

Gravity flow

A gravity drainage system limits capacity to one-third water, that adheres to the inner pipe wall, with a large two-thirds air core.

Terrain Siphonic Roof Drainage

With the Terrain Siphonic Roof Drainage System, air is purged from the pipe so that it runs 100% full of water, enabling smaller diameter pipes to remove higher volumes of rainwater.

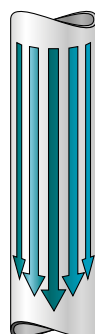

Design Freedom

With the Terrain Siphonic Roof Drainage System, collector pipes can be installed horizontally without a slope, allowing the design team to control downpipe locations.

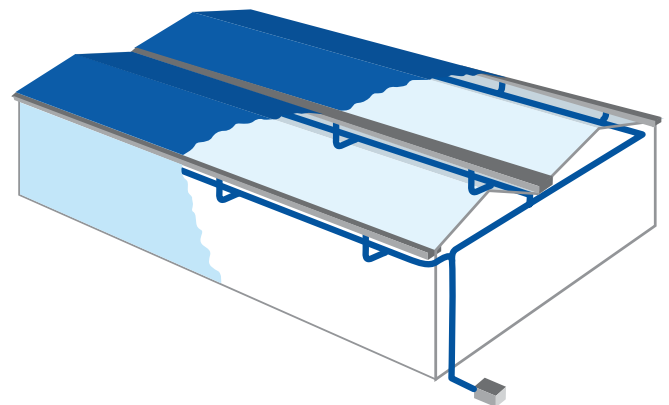

This enables a significant reduction in underground drainage, trenching, soil removal, treatment of backfill and often means no drainage is required under the building floor slab.

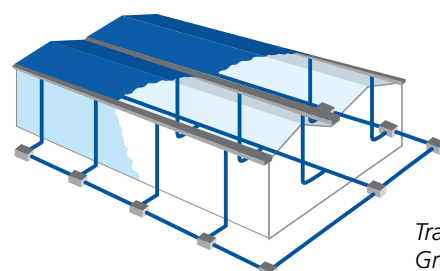

Traditional Gravity Fed System

Terrain Underground Drainage



Introduction

Using the latest plastics manufacturing technology to satisfy the requirements of today's installers, the Terrain underground range offers both rigid and foam core pipe and a comprehensive range of fittings to suit all applications.

Terrain underground products represent the benchmark for quality, supported with outstanding service levels.

Our comprehensive range of underground drainage products are suitable for commercial, industrial, housing and public sector developments.

They are:

- Easy-to-lay
- Flexible, to accommodate normal ground movement
- Adaptable, to connect to existing drainage systems
- Unique products offer unrivalled installation options
- Suitable for commercial and domestic installations

Systems include:





Solid wall pipes and fittings

Available in 82, 110 and 160mm diameters. 110 and 160mm comply with BS EN 1401 (BS 4660).



Foamcore pipe

Manufactured using the latest tri-extrusion techniques to produce a three layer pipe that is 25% lighter than standard PVCu pipe. Available in 110 and 160mm diameters.

Underground Drainage

Pipe						
	Size mm	Angle	Col	Pack/Box	Code	Price Each
Pipe plain ended						
	82 (5.8m)		T	1/88	3DP58	£151.39
	110 (5.8m)	♥	T	1/67	4DP58	£158.86
	160 (5.8m)	♥	T	1/33	6DP58	£327.46
Pipe single socket						
	110 (3m)	♥	T	1/67	4DP35	£98.47
Foamcore pipe plain ended						
	110 (3m)		T	1/67	4EUP3	£81.03
	110 (5.8m)		T	1/67	4EUP58	£148.36
	160 (5.8m)		T	1/33	6EUP58	£317.05
Foamcore pipe single socket						
	110 (6m)		T	1/67	4EUP65	£164.67

Prices shown are for one item excluding VAT

Fittings						
	Size mm	Angle	Col	Pack/Box	Code	Price Each
Coupler double socket						
	With central stop.					
	82		T	10/60	3D20D	£31.54
	110	♥	T	5/48	4D20D	£15.02
160	♥	T	5/15	6D20D	£41.44	
Slip coupler						
	For inserting new fittings into existing pipework. (e.g. refurbishment or repair). No central stop.					
	110		T	5/45	4D20DSC	£22.45
Pipe end socket						
	110	♥	T	5/40	4D69	£25.38
	160	♥	T	1/15	6D69	£51.72

Prices shown are for one item excluding VAT

Colours: T - Terracotta R - Red B - Black

Fittings						
	Size mm	Angle	Col	Pack/Box	Code	Price Each
Short radius bend double socket						
	To change pipe direction: 87½°, 45°, 30° and 15° as standard.					
	82	87½	T	1/15	3D23D	£45.34
	82	45	T	5/20	3D25D	£43.32
	110	87½	♥	5/18	4D23D	£45.58
	110	45	♥	5/26	4D25D	£46.57
	110	30	T	5/35	4D27D	£46.57
	110	15	T	5/35	4D29D	£46.57
	160	87½	♥	1/6	6D23D	£108.27
	160	45	♥	1/8	6D25D	£108.27
	Short radius bend single socket					
	To change pipe direction: 87½°, 45°, 30° and 15° as standard.					
	110	45	T	5/35	4D25	£39.11
	110	30	T	5/15	4D27	£39.98
	110	15	T	5/40	4D29	£39.11
	160	87½	T	5/10	6D23	£94.22
	160	45	T	5/8	6D25	£94.22
	160	30	T	4/12	6D27	£96.00
Rest bend single socket						
	To change 110mm pipe direction at base of soil stack: 87½° as standard. Satisfies recommendations of BS 5772: 1994.					
	110	87½	T	5/10	4D21	£66.68
Rest bend double socket						
	To change 110mm pipe direction at base of soil stack: 87½° as standard. Satisfies recommendations of BS 5772: 1994.					
	110		T	3/9	4D21D	£74.49
Variable bend single socket						
	To change 110mm pipe direction by 0–25°. Any non-standard angle can be achieved if used in conjunction with a standard fitting.					
	110	0-25	♥	5/25	4DV40	£63.50
Socket plug						
	To blank off any ring seal socket. With boss horn.					
	110		♥	6/54	4D68	£27.14
	160		♥	1/30	6D68	£52.53

Prices shown are for one item excluding VAT

Terrain

Fittings

	Size mm	Angle	Col	Pack/Box	Code	Price Each	
Access cap							
	To allow full bore access to 82mm, 110mm or 160mm pipework for inspection or rodding.						
	110	♥	T	5/50	4D64	£52.36	
	160	♥	T	1/15	6D64	£84.79	
	110		T	1/40	4D63	£44.30	
	160		T	1/35	6D63	£78.87	
Rodding eye							
	Material: Aluminium. Elliptical rodding eye with 110mm pipe size spigot. Access aperture size: 118x90mm.						
	110		Self	5/25	4DRE	£125.99	
Single equal junction							
	To join 82mm branch pipe to 82mm main pipe at an angle: 45° as standard.						
	82	45	T	1/20	3D33D	£65.03	
Single equal junction - all equal sockets							
	To join 110mm or 160mm branch pipe to 110mm or 160mm main pipe at an angle: (110mm) 87½° and 45° as standard (160mm) 45° as standard						
	110	87½	♥	T	12	4D30D	£64.51
	160	87½	T	4	6D30D	£180.68	
	110	45	♥	T	12	4D33D	£64.51
	160	45	♥	T	3	6D33D	£180.68
Equal sockets plus spigot outlet							
	To join 110mm or 160mm branch pipe to 110mm or 160mm main pipe at an angle: (110mm) 87½° and 45° as standard (160mm) 45° as standard						
	110	87½	T	5/15	4D30	£57.48	
Single unequal junction - all socket							
	To join 110mm branch pipe to 160mm main pipe at an angle: 45° and 87½° as standard.						
	160/110	45	♥	T	5	64D33D	£161.38

Gullies & Hoppers







	Size mm	Angle	Col	Pack/Box	Code	Price Each
Gully trap						
	Material: Polypropylene To obtain 'P' trap, add 45° bend.					
	110		T	4/12	4DG90	£54.15
'P' trap						
	Material: PVCu To obtain 'Q' or 'S' trap, add 45° or 87½° bend.					
	110		T	4/8	4DG91	£98.10
Square hopper head						
	Material: PVCu and Polypropylene Spigot outlet may be cut off to reveal socket which can accept solvent-welded pipe as extended spigot. Terracotta body with Black grid. 1 boss horn.					
	110		T	5/15	4DG92	£47.23
Rectangular hopper head						
	Material: PVCu and Polypropylene Back inlet plate incorporates two easily removable discs to create apertures for insertion of 40mm waste pipes. Terracotta body with Black grid. 3 boss horns.					
	110		T	4/12	4DG93	£85.80
Circular gully						
	Material: PVCu Incorporates plugged horizontal pipe entries: 2x110mm spigots, 1x110mm ring seal socket and 1x68mm rainwater pipe socket. Spigot outlet may be cut off to reveal socket which can accept solvent-welded pipe as extended spigot.					
	110		T	2/4	4DG80	£137.10
Bottle gully with round cover						
	Material: PVCu and Polypropylene. Removable dip tube provides 50mm deep trap. Incorporates 110mm back inlet connection. Terracotta body with Black cover.					
	110		T	4	4DG97	£153.47
Bottle gully with square cover						
	Material: PVCu and Polypropylene Removable dip tube provides 50mm deep trap Incorporates 2 x waste back inlet connections. Can also accept up to 6 different pipes either direct or via adaptors. Terracotta body with Black cover.					
	110		T	4	4DG89	£178.90

Prices shown are for one item excluding VAT







Prices shown are for one item excluding VAT

Underground Drainage

Gullies & Hoppers

	Size mm	Angle	Col	Pack/Box	Code	Price Each
Sealed cover						
	To cap 4DG80 Circular Gully or 4DG81 Extension Piece With screws and seal.					
	211		B	1/30	4DG82	£71.89
Circular grating						
	To provide an open grating for surface water drainage for 4DG80 Circular Gully or 4DG81 Extension Piece. Also: spare grating for 4DG97 Bottle Gully.					
	211		B	1/30	4DG83	£33.03
Raising piece						
	To extend upper aperture of 4DG97 Bottle Gully to surface level or to lower horizontal pipe entries beneath surface level.					
	200		T	3	4DG96	£93.48
Square hopper head grid						
	Material: Polypropylene. Spare grid for 4DG92 Hopper Head.					
	155		B	1/100	4DG92G	£10.00
	Material: Polypropylene. Spare grid for 4DG89 Hopper Head.					
	232		B	1/15	4DG89G	£14.92
Square sealed cover						
	Material: Polypropylene. Converts 4DG92 Square Hopper. Head from open grid to sealed cover. With screws and seal.					
	155		B	1/100	4DG92GS	£44.26

Inspection Chambers

	Size mm	Angle	Col	Pack/Box	Code	Price Each
Shallow inspection chamber						
	To allow inspection of drainage system. Supplied with 2 plugs for unused entries. 200mm socket has angular tolerance of $\pm 7^\circ$ allowing up to 14° adjustment to accommodate pipe variation and ground fall. Access aperture size: 162x100mm. Requires seal 9116.4 found on page 19.					
	110		T	2	4DI600	£164.97
Sealed cover and frame						
	To cap 4DI600 Shallow Inspection Chamber. Ring seal joint to shaft					
	110		B	4/12	4DIFC1	£129.01
Inspection chamber base - 470mm diameter						
	Material: Polypropylene. To allow inspection of drainage system. Incorporating 110mm main channel and 4 x 110mm branch inlets. Supplied with 4 x blanking plugs					
	110		B	1	4DI240B	£266.98
Unequal inspection chamber base - 475 diameter						
	Material: Polypropylene supplied with 4 x blanking plugs. To allow inspection of drainage system, incorporating 160mm main channel, 2 x 160mm and 2 x 110mm branch inlets.					
	160/110		B	1	64DI240B	£294.07
Raising piece						
	Material: Polypropylene. To extend height of Inspection Chamber Base (4DI240B & 64DI240B) to surface level. Requires seal (4DI2155).					
	470		B	1	4DI215R	£108.38
Seal ring						
	Material: Polypropylene. To allow inspection of drainage system, incorporating 160mm main channel, 2 x 160mm and 2 x 110mm branch inlets.					
			B	1	4DI215S	£25.66
Cover and frame						
	Material: Polypropylene cover and frame. BS EN 124: 1994 – Group 1, Class A15 (formerly BS497: 1976 Class C+). For domestic drive-ways accessible to vehicles up to one tonne maximum wheel load.					
	579		B	1	4DIFC4	£315.11

Prices shown are for one item excluding VAT

Colours: T - Terracotta R - Red B - Black

Prices shown are for one item excluding VAT

Reducers & Adaptors

Size mm	Angle	Col	Pack/Box	Code	Price Each
---------	-------	-----	----------	------	------------

Level invert taper



Material: PVCu.

Larger end spigot and smaller end socket.

110/82	▽	T	2/30	43DT	£30.99
160/110	▽	T	4/24	64DT	£58.92

Universal waste adaptor



Material: EPDM.

For connecting 32mm, 40mm or 50mm waste pipe to 110mm underground drain pipe.

110		B	5/60	4DW200	£31.93
-----	--	---	------	---------------	---------------

Adaptor to above ground drain



Material: Flex PVC.

For connecting 82mm underground drain. External only.

82/68		B	5/60	3DW25	£33.89
110/68		B	5/50	4DW25	£31.93
110/82		B	5/50	4DW3	£32.64



Material: Flex PVC. For connecting 62mm square downpipes to underground drainage system.
For square downpipe.

110/62		B	5/50	4DW23	£32.64
--------	--	---	------	--------------	---------------

PVCu underground drain pipe to clay



Material: PVCu. Socket for PVCu drain pipe and ribbed socket for other material. Cold caulked.

110		T	1/36	4D73	£42.18
-----	--	---	------	-------------	---------------

Lubricant

Please refer to page 22

Index

Code	Pack Qty	Price	Page
------	----------	-------	------

Pipe and Fittings

3D20D	10/60	£31.54	47
3D23D	1/15	£45.34	47
3D25D	5/20	£43.32	47
3D33D	1/20	£65.03	48
3DP58	1/88	£151.39	47
4D20D	5/48	£15.02	47
4D20DSC	5/45	£22.45	47
4D21	5/10	£66.68	47
4D21D	3/9	£74.49	47
4D23D	5/18	£45.58	47
4D25	5/35	£39.11	47
4D25D	5/26	£46.57	47
4D27	5/15	£39.98	47
4D27D	5/35	£46.57	47
4D29	5/40	£39.11	47
4D29D	5/35	£46.57	47
4D30	5/15	£57.48	48
4D30D	12	£64.51	48
4D33D	12	£64.51	48
4D63	1/40	£44.30	48
4D64	5/50	£52.36	48
4D68	6/54	£27.14	47
4D69	5/40	£25.38	47
4DP35	1/67	£98.47	47
4DP58	1/67	£158.86	47
4DRE	5/25	£125.99	48
4DV40	5/25	£63.50	47
4EUP3	1/67	£81.03	47
4EUP58	1/67	£148.36	47
4EUP65	1/67	£164.67	47
6D33D	5	£161.38	48
6D20D	5/15	£41.44	47
6D23	5/10	£94.22	47
6D23D	1/6	£108.27	47
6D25	5/8	£94.22	47
6D25D	1/8	£108.27	47
6D27	4/12	£96.00	47
6D30D	4	£180.68	48
6D33D	3	£180.68	48
6D63	1/35	£78.87	48
6D64	1/15	£84.79	48
6D68	1/30	£52.53	47
6D69	1/15	£51.72	47
6DP58	1/33	£327.46	47
6EUP58	1/33	£317.05	47

Gullies and Hoppers

4DG80	2/4	£137.10	48
4DG82	1/30	£71.89	49
4DG83	1/30	£33.03	49
4DG89	4	£178.90	48
4DG89G	1/15	£14.92	49
4DG90	4/12	£54.15	48
4DG91	4/8	£98.10	48
4DG92	5/15	£47.23	48
4DG92G	1/100	£10.00	49
4DG92GS	1/100	£44.26	49
4DG93	4/12	£85.80	48
4DG96	3	£93.48	49
4DG97	4	£153.47	48

Inspection Chambers

4DI215R	1	£108.38	49
4DI215S	1	£25.66	49
4DI240B	1	£266.98	49
4DI600	2	£164.97	49
4DIFC1	4/12	£129.01	49
4DIFC4	1	£315.11	49
64DI240B	1	£294.07	49

Index

Code	Pack Qty	Price	Page
------	----------	-------	------

Reducers and Adaptors

3DW25	5/60	£33.89	50
43DT	2/30	£30.99	50
4D73	1/36	£42.18	50
4DW200	5/60	£31.93	50
4DW23	5/50	£32.64	50
4DW25	5/50	£31.93	50
4DW3	5/50	£32.64	50
64DT	4/24	£58.92	50





Flexicon Couplings

Flexicon couplings are available as straight connections or adaptors for a wide range of pipe materials and sizes.

These robust EDPM flexible rubber couplings have been manufactured to BS EN 681-1 and are ideal for jointing pipes for sewerage, drainage and other low pressure applications.

Flexicon couplings can be manufactured from other types of rubber to suit customer requirements.

Flexicon Adaptors						
	Range A/Bmm	Min Length	Pack/ Qty	Driver A/B mm	Code	Price Each
Flexicon Universal Adaptors (XAC)						
	120-135/100-115	100	1	7/7	XAC400	£24.52
Flexicon Drainage Adaptors (XAC)						
	100-115/75-85	100	1	7/7	XAC85/115	£40.37
	100-115/85-95	100	1	7/7	XAC95/115	£40.99
	130-145/110-125	120	1	7/7	XAC125/145T	£52.79
	150-165/100-115	120	1	7/7	XAC115/165	£56.96
	160-175/110-125	120	1	7/7	XAC125/175	£62.67
Flexicon Plumbing Adaptors (XPA)						
	50-65/30-45	80	1	7/7	XPA45/65	£22.04
	80-95/45-50	100	1	7/7	XPA50/95	£26.21

Prices shown are for one item excluding VAT

Colours: T - Terracotta R - Red B - Black

Flexicon Couplings						
	Range A/Bmm	Min Length	Pack/ Qty	Driver A/B mm	Code	Price Each
Flexicon Drain Couplings (XDR)						
	50-65	95	1	7	XDR65	£24.86
	80-95	110	1	7	XDR95	£25.25
	100-115	110	1	7	XDR115	£25.72
	110-125	120	1	7	XDR125	£26.77
	150-165	120	1	7	XDR165	£45.89
	150-175	120	1	7	XDR175	£57.16
	175-200	150	1	8	XDR200	£59.95
Flexicon Shear Band Standard Couplings (XSB)						
	100-115	120	1	8	XSB115	£10.34
	110-125	120	1	8	XSB125	£56.38
Flexicon End Caps						
	Range A/Bmm	Min Length	Pack/ Qty	Driver A/B mm	Code	Price Each
Flexicon End Caps (XST)						
	50-65		1	7	XST65	£11.80
	80-95		1	7	XST95	£14.58

Prices shown are for one item excluding VAT

Prices shown are for one item excluding VAT



POLYPIPE
ADVANTAGE

Also available
from Polypipe

SIMPLE 'CLICK' CON-
NECTION

SIMPLE
ELECTROFUSION WELD

B-s1, d0*
FIRE CLASSIFICATION

MecFlow

CLICK. WELD. DONE.

Introducing a new water supply system. One that's quick to install with a unique and simple click and electrofusion welding system. One that's material formulation achieves a fire classification of B-s1, d0* and is suitable for multiple water supply applications. Designed and manufactured off-site through our Polypipe Advantage service, MecFlow is delivered in a kit, ready to install for a smart, quick installation.

MecFlow – The future of water supply

*Fire classification rating according to EN13501, installed according to building regulations.
We recommend MecFlow be installed with our Firetrap sleeves.

For more information, visit polypipe.com/mecflow

 **Polypipe**

Terrain Standards and Certification

Quality Assurance

Polypipe Building Services is accredited to the following Quality Management Systems:

BS EN ISO 9001
BS EN ISO 14001
BS ISO 45001
PAS 99



Certifications

Terrain FUZE is covered by:

British Board of Agrément certificate 07/4479



Standards Compliance

Soil and Waste

Terrain systems comply with the appropriate British and European Standard and, where applicable, bear a kitemark.

PVCu Soil Systems – 82, 110 and 160mm Soil Pipes and Fittings

BS 4514 and BS EN 1329-1

PVCu Waste Systems – 32, 40 and 50mm Waste Pipes and Fittings

BS EN 1566 and BS 5255

Solvent Liquid Weld

BS EN 14680

Air Admittance Valve

BS EN 12380

Terrain systems also comply with many of the requirements of DIN and ISO.

Underground

Terrain underground complies with the appropriate British Standard/European Norm and, where applicable, is Kitemarked to BS EN 1401-1.

Flexible Couplers

Flexible Rubber Couplers and Adaptors to EN 295-1, Shear Band Couplings to WIS4-41-01. EN681-1 EPDM Rubber.

Siphonics

Terrain Siphonic Roof Drainage System complies with BS EN 12056-3 and designs in accordance with BS 8490.

Terrain Advantage

From time and cost-savings to scheduled system delivery and enhanced Health & Safety on site, there are a number of ways that the Polypipe Advantage service can benefit your project.

There's never been a better time to experience these benefits for yourself. The construction industry is currently undergoing a period of change, brought about by technological advancements, shifts in the labour market and an increasing focus on environmental issues. Whichever system you require to help overcome your unique challenges, we make it. Simple.

Get in touch

See how Polypipe Advantage can benefit your next project.

Contact the Polypipe Advantage team and remove the complexity from design, estimation, fabrication, delivery and support.

Contact details below.

Availability

For details of local stockists, please contact Sales Support on 01622 795410.

Further information and assistance

Terrain products are backed by a comprehensive technical advisory service, available to provide advice and design guidance on all aspects of above and below ground drainage.

Technical services include:

- On site advice and problem solving.
- Terrain fabrication and fabrication design service.

For prompt assistance, please contact the Terrain Technical Services Department:

Tel: 01622 795200

Email: commercialenquiries@polypipe.com

www.polypipe.com/commercial-building-services



Notes

Terrain Drainage Systems



Polypipe Building Services

New Hythe Business Park

College Road

Aylesford

Kent ME20 7PJ

Tel: 01622 795 200

Fax: 01622 795 263

commerciaenquiries@polypipe.com

www.polypipe.com/commercial-building-services