

Technical Catalogue 2015

Malleable cast iron fittings



The advantages of a proven solution



+ Concept

Standardized components such as malleable cast iron fittings for long-lasting piping concepts were invented; not like for individual systems, where new systems continuously replace the previous. Availability of spare parts is practically unlimited and piping amendments can be done on a long-term basis.

+ Product and Features

Choose from the largest range. Our product features include hot-dip galvanizing suitable for drinking water, corrosion-resistant solid designs, high-grade materials, special ranges for high pressures, and much more.

+ Quality

A sophisticated third-party monitored quality management system and certified products provide safety. CPR, RoHS, PED – we are at the cutting edge of new regulations and offer assistance and customer support for proof of conformity.

+ Reliability

Reliable logistics from the European central warehouse and leading stock trade partners to ensure availability in each market for our end users. Our business is characterised by long-term partnerships with our customers.

+ Support

We support customers with CAD geometry for piping design, EAN bar-coding on the packaging, EDI-ordering service and advice in each of our markets for jointing technology and application issues.

Table of Contents

General information	4
Assortment overview for Georg Fischer Malleable cast iron fittings	7
Product Range	8
FM certified assortment	67
Technical product notes	68
Application notes	77
Planning of Piping Systems	82
General Terms and Conditions	107

The technical data given in this publication are for general information purposes only.
They imply no warranty of whatever kind. Please consult our General Terms and Conditions of Supply.

General Information

Product standards

The international malleable cast iron pipe fittings standard ISO 49 and the European malleable cast iron pipe fittings standard EN 10242 apply. Both standards are almost equal. The European fittings standard (EN 10242) has been adopted by most European countries as a national version (DIN EN 10242, ÖNORM EN 10242, SN EN 10242, etc.), whilst the former national standards have been withdrawn (e.g. DIN 2950). The British Standard is an exception. BS 143 & 1256 has merely been partially superseded by BS EN 10242. Parts of BS 143 & 1256 remain valid as on the one hand also fittings made of copper based materials are covered and on the other hand some types/shapes of malleable cast iron fittings are included, which are not covered by BS EN 10242.

In EN 10242 (and ISO 49) the different combinations of malleable cast iron grades and types of jointing threads, offered by the different manufacturers are grouped into so called «Design Symbols». These «Design Symbols» have been introduced to facilitate the specification/designation of the fittings execution for tendering or ordering process. They are not intended to be used for marking of the fitting or packaging.

Georg Fischer malleable cast iron fittings are exclusively manufactured from decarburised annealed (white) malleable cast iron type EN-GJMW-400-5 and with Rp and R jointing threads. Thus they comply with Design Symbol A.

Elements of the standard designation

For vendor independent public tenders, inquiries, etc. EN 10242 and ISO 49 provide a syntax for product designation. To indicate the Design Symbol is imperative within this syntax in order to define material and thread type properly.

As an example the designation for an equal elbow with 2 internal threads, fitting size ½, galvanised, Design Symbol A is:

Elbow EN 10242 – A1 – ½ – Zn – A

①	②	③	④	⑤	⑥
---	---	---	---	---	---

The standard designation is structured as follows:

Designation	Explanation
① Type of fitting	Kind of fitting shape
② Product standard	EN 10242 (ISO 49)
③ Symbol	see Product Range, „ISO / EN ... “ above the tables
④ Fitting size(s)	given in inch (see column “Dimension” of Product Range)
⑤ Surface	Fe = black Zn = galvanised
⑥ Design Symbol	A, B, C or D see explanation in tab. 1

tab. 2 Explanation of standard designation

Design Symbol	Type of material acc. to EN 1562	Tensile strength in N/mm ²	Elongation in %	Jointing thread
A	EN-GJMW-400-5	400	5	parallel internal thread Rp and taper external thread R acc. to EN 10226-1/ISO 7-1
	EN-GJMB-350-10	350	10	
B	EN-GJMW-350-4	350	4	
	EN-GJMB-300-6	300	6	
C*	EN-GJMW-400-5	400	5	taper internal thread Rc* and taper external thread R acc. to EN 10226-2/ISO 7-1
	EN-GJMB-350-10	350	10	
D*	EN-GJMW-350-4	350	4	
	EN-GJMB-300-6	300	6	

* Not used at Continental Europe, respectively partially prohibited by national regulations.

tab. 1 Design Symbols for malleable cast iron fittings

Size designation

The designation of types of fittings starts from the simplest possible basic types such as bend, elbow, tee, cross etc.; basic features are also indicated.

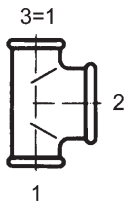

illustr. 1/A

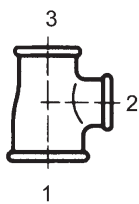

illustr. 1/B

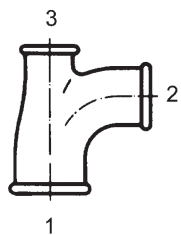

illustr. 1/C

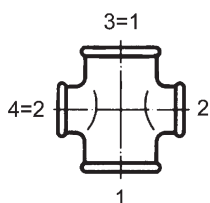

illustr. 1/D

The following rules apply for the sequence of connection sizes:

- for **equal fittings** giving the individual connection size once is sufficient.
- for **reducing fittings with 2 connections of different sizes the connection size of the larger is given first, than the one of the smaller connection.** **Exception:** Elbow A4 internal/external thread (catalogue no. 92) - first the connection size of the internal thread.
- for fittings **with 3 or more connections** (illustr. 1/A and 1/D) in case of equal connections on the run it is sufficient to give the size of the run first, followed by the size of the branch.
- for **3 different connections sizes or fittings reduced in run** the sequence for the designation of connections according to illustr. 1/B and 1/C applies.

Example T with internal threads $1 \frac{1}{4}$ on the run and $\frac{3}{4}$ at the branch, black, Design Symbol A:

Tee EN 10242 – B1 – $1 \frac{1}{4} \times \frac{3}{4}$ – Fe – A

Example Pitcher-T with internal threads 2 and $\frac{1}{2}$ on the run and $1 \frac{1}{4}$ at the branch, galvanised, Design Symbol A:

Pitcher-Tee EN 10242 – E1 – $2 \times 1 \frac{1}{4} \times \frac{1}{2}$ – Zn – A

Elements of the Georg Fischer designation

For inquiries and orders Georg Fischer introduced a simple product designation. It consist of:

Designation	Explanation
Type of fitting	catalogue number (see Product Range)
Fitting size(s)	given in inch (see column "Dimension" of Product Range)
Surface	B = black G = galvanised

tab. 3 Explanation of Georg Fischer designation

To avoid errors during specification, the 9 digit Georg Fischer code, given in the following chapter Product Range can be used as well.

In both cases the Design Symbol must not be indicated, since Georg Fischer exclusively produces fittings according to Design Symbol A.

Example of designation for an Equal elbow with 2 internal threads, fitting size $\frac{1}{2}$, galvanised, Design Symbol A:

90 - $\frac{1}{2}$ G or 770 090 204

Surface finish

Georg Fischer malleable cast iron fittings are supplied in black or hot dip galvanised finish, covered with a preservative coating for temporary prevention of a rust film.

Exceptions are fittings marked with "ST" which are made of steel, and if a galvanised finish is required, are electroplated for technical reasons instead of hot dip galvanising.

Due to the lower corrosion protection electroplated zinc surfaces are not suitable for drinking water application.

According to the European and International standard malleable cast iron pipe fittings must be free from polycyclic aromatic hydrocarbons.

Corporate Policy

The success of our corporation is secured only if we fulfil the requirements of our customers regarding product performance, quantities, on time delivery, price and service and all needs of our company environment are respected. Our aim is to improve customer satisfaction, delivery service as well as environmental and health and safety performance by continuous enhancement of product and process quality. We base this process on our Integrated Management System, which we improve continuously and rely on our competent employees, which we lead with targets and support in their personal development.

We consequently aim to implement and "live" the Georg Fischer Values.

Our Integrated Management System is certified according to EN ISO 9001, EN ISO 14001 und BS OHSAS 18001.

Actual certificates can be order at www.fittings.at/contactform



Quality testing

Georg Fischer malleable cast iron fittings are individually tested within the framework of the existing standard. The testing of pressure carrying unions is carried out on their piece parts.

Measurements

The measurements given in this catalogue represent the status at the time of printing – mistakes and printing errors excluded. For important cases of application the measurements should be ensured by queries.

Product presentation at chapter "Product Range"

This document shows all malleable cast iron fittings and piece parts of Georg Fischer Fittings GmbH. Products without position or code number are shown for information purposes only and are not part of the delivery program.

The individual fittings are displayed by using **symbolic pictures** and **drawings** with all essential measurements for the application. International standardized types of fittings are headed by the **ISO/EN symbol**.

Symbols

EN	... the first column "EN" indicates the fittings standardised in European Standard EN 10242: <ul style="list-style-type: none">● ... standardised- ... not standardised
B/G	... B = balck G = galvanised
ST	... these types of fittings are made from steel (galvanised finish = electroplated) and are not suitable for drinking water installations.
Code	... Georg Fischer part number
ISO/EN	... symbol to ISO 49/EN 10242
R	... taper external thread, for connections to EN 10226-1 and/or ISO 7-1 sealing on the threads.
Rp	... parallel internal jointing thread for connections to EN 10226-1 and/or ISO 7-1 sealing on the threads.
G	... parallel internal fastening thread for connections to EN ISO 228-1 not sealing on the thread.
G ... B	... parallel external fastening thread, tolerance class B for connections to EN ISO 228-1 not sealing on the threads.
ET	... piece part
s	... width across flat The given measurement states the size of the screw-wrench that is to be used.
*	... notes

Malleable cast iron fittings - Assortment overview

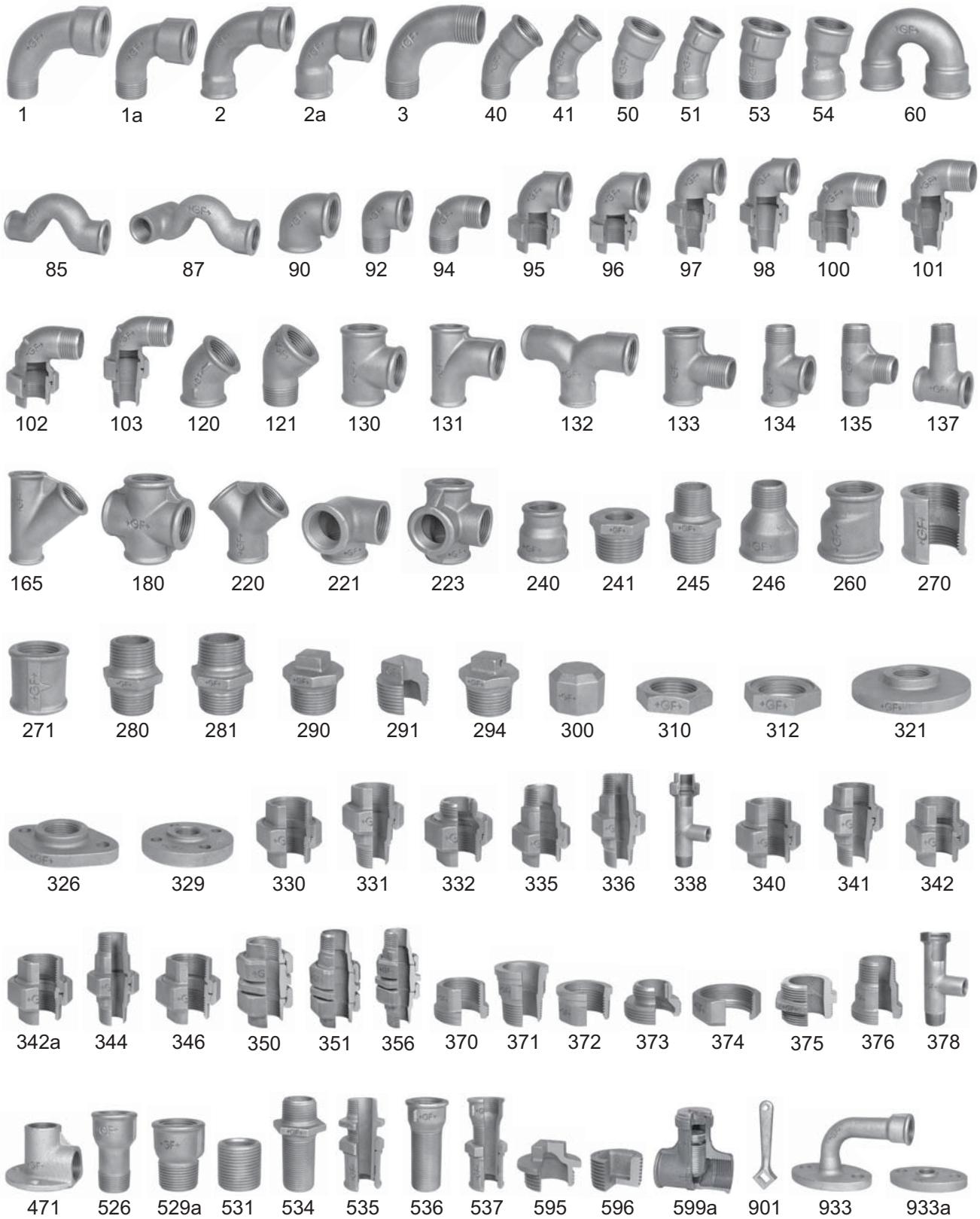

Malleable cast iron fittings - Product Range

1 Long sweep bend 90°, ISO/EN G4

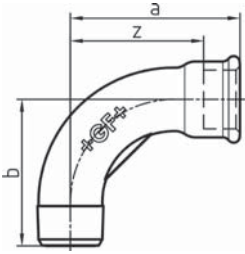

EN	B/G	Dim. [inch]	Code	a [mm]	b [mm]	z [mm]
•	B	1/8	770 001 101	35	32	28
•	G	1/8	770 001 201	35	32	28
•	B	1/4	770 001 102	40	36	30
•	G	1/4	770 001 202	40	36	30
•	B	3/8	770 001 103	48	42	38
•	G	3/8	770 001 203	48	42	38
•	B	1/2	770 001 104	55	48	42
•	G	1/2	770 001 204	55	48	42
•	B	3/4	770 001 105	69	60	54
•	G	3/4	770 001 205	69	60	54
•	B	1	770 001 106	85	75	68
•	G	1	770 001 206	85	75	68
•	B	1 1/4	770 001 107	105	95	86
•	G	1 1/4	770 001 207	105	95	86
•	B	1 1/2	770 001 108	116	105	97
•	G	1 1/2	770 001 208	116	105	97
•	B	2	770 001 109	140	130	116
•	G	2	770 001 209	140	130	116
•	B	2 1/2	770 001 110	176	165	149
•	G	2 1/2	770 001 210	176	165	149
•	B	3	770 001 111	205	190	175
•	G	3	770 001 211	205	190	175
•	B	4	770 001 112	260	245	224
•	G	4	770 001 212	260	245	224

1a Short bend 90°, ISO/EN D4

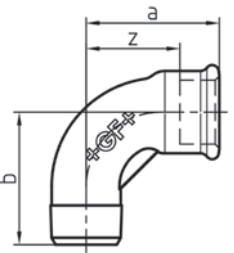

EN	B/G	Dim. [inch]	Code	a [mm]	b [mm]	z [mm]
•	B	1/4	770 011 102	30	30	20
•	G	1/4	770 011 202	30	30	20
•	B	3/8	770 011 103	36	36	26
•	G	3/8	770 011 203	36	36	26
•	B	1/2	770 011 104	45	45	32
•	G	1/2	770 011 204	45	45	32
•	B	3/4	770 011 105	50	50	35
•	G	3/4	770 011 205	50	50	35
•	B	1	770 011 106	63	63	46
•	G	1	770 011 206	63	63	46
•	B	1 1/4	770 011 107	76	76	57
•	G	1 1/4	770 011 207	76	76	57
•	B	1 1/2	770 011 108	85	85	66
•	G	1 1/2	770 011 208	85	85	66
•	B	2	770 011 109	102	102	78
•	G	2	770 011 209	102	102	78
-	B	2 1/2	770 011 110	115	115	88
-	G	2 1/2	770 011 210	115	115	88
-	B	3	770 011 111	127	127	97
-	G	3	770 011 211	127	127	97
-	B	4	770 011 112	165	165	129
-	G	4	770 011 212	165	165	129

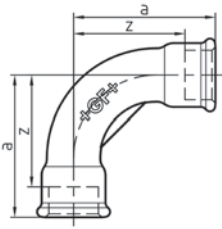

2 Long sweep bend 90°, ISO/EN G1

EN	B/G	Dim. [inch]	Code	a [mm]	z [mm]
•	B	1/4	770 002 102	40	30
•	G	1/4	770 002 202	40	30
•	B	3/8	770 002 103	48	38
•	G	3/8	770 002 203	48	38
•	B	1/2	770 002 104	55	42
•	G	1/2	770 002 204	55	42
•	B	3/4	770 002 105	69	54
•	G	3/4	770 002 205	69	54
•	B	1	770 002 106	85	68
•	G	1	770 002 206	85	68
•	B	1 1/4	770 002 107	105	86
•	G	1 1/4	770 002 207	105	86
•	B	1 1/2	770 002 108	116	97
•	G	1 1/2	770 002 208	116	97
•	B	2	770 002 109	140	116
•	G	2	770 002 209	140	116
•	B	2 1/2	770 002 110	176	149
•	G	2 1/2	770 002 210	176	149
•	B	3	770 002 111	205	175
•	G	3	770 002 211	205	175
•	B	4	770 002 112	260	224
•	G	4	770 002 212	260	224

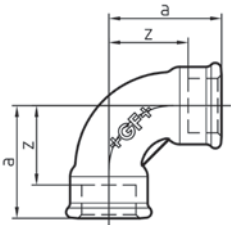

2a Short bend 90°, ISO/EN D1

EN	B/G	Dim. [inch]	Code	a [mm]	z [mm]
•	B	1/4	770 012 102	30	20
•	G	1/4	770 012 202	30	20
•	B	3/8	770 012 103	36	26
•	G	3/8	770 012 203	36	26
•	B	1/2	770 012 104	45	32
•	G	1/2	770 012 204	45	32
•	B	3/4	770 012 105	50	35
•	G	3/4	770 012 205	50	35
•	B	1	770 012 106	63	46
•	G	1	770 012 206	63	46
•	B	1 1/4	770 012 107	76	57
•	G	1 1/4	770 012 207	76	57
•	B	1 1/2	770 012 108	85	66
•	G	1 1/2	770 012 208	85	66
•	B	2	770 012 109	102	78
•	G	2	770 012 209	102	78
-	B	2 1/2	770 012 110	115	88
-	G	2 1/2	770 012 210	115	88
-	B	3	770 012 111	127	97
-	G	3	770 012 211	127	97
-	B	4	770 012 112	165	129
-	G	4	770 012 212	165	129

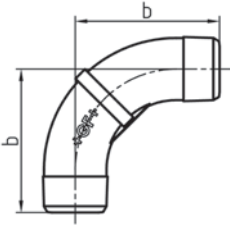

3 Long sweep bend 90°, ISO/EN G8

EN	B/G	Dim. [inch]	Code	b [mm]
-	B	1/4	770 003 102	33
-	G	1/4	770 003 202	33
•	B	3/8	770 003 103	42
•	G	3/8	770 003 203	42
•	B	1/2	770 003 104	48
•	G	1/2	770 003 204	48
•	B	3/4	770 003 105	60
•	G	3/4	770 003 205	60
•	B	1	770 003 106	75
•	G	1	770 003 206	75
•	B	1 1/4	770 003 107	95
•	G	1 1/4	770 003 207	95
•	B	1 1/2	770 003 108	105
•	G	1 1/2	770 003 208	105
•	B	2	770 003 109	130
•	G	2	770 003 209	130
-	G	2 1/2	770 003 210	165

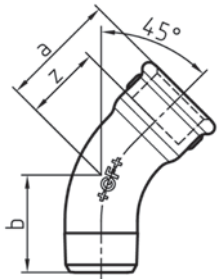

40 Long sweep bend 45°, ISO/EN G4/45°

EN	B/G	Dim. [inch]	Code	a [mm]	b [mm]	z [mm]
•	B	1/4	770 040 102	26	21	16
•	G	1/4	770 040 202	26	21	16
•	B	3/8	770 040 103	30	24	20
•	G	3/8	770 040 203	30	24	20
•	B	1/2	770 040 104	36	30	23
•	G	1/2	770 040 204	36	30	23
•	B	3/4	770 040 105	43	36	28
•	G	3/4	770 040 205	43	36	28
•	B	1	770 040 106	51	42	34
•	G	1	770 040 206	51	42	34
•	B	1 1/4	770 040 107	64	54	45
•	G	1 1/4	770 040 207	64	54	45
•	B	1 1/2	770 040 108	68	58	49
•	G	1 1/2	770 040 208	68	58	49
•	B	2	770 040 109	81	70	57
•	G	2	770 040 209	81	70	57
•	B	2 1/2	770 040 110	99	86	72
•	G	2 1/2	770 040 210	99	86	72
•	B	3	770 040 111	113	100	83
•	G	3	770 040 211	113	100	83
-	B	4	770 040 112	141	130	105
-	G	4	770 040 212	141	130	105

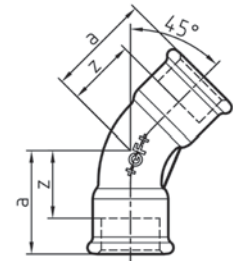

41 Long sweep bend 45°, ISO/EN G1/45°

EN	B/G	Dim. [inch]	Code	a [mm]	z [mm]
•	B	3/8	770 041 103	30	20
•	G	3/8	770 041 203	30	20
•	B	1/2	770 041 104	36	23
•	G	1/2	770 041 204	36	23
•	B	3/4	770 041 105	43	28
•	G	3/4	770 041 205	43	28
•	B	1	770 041 106	51	34
•	G	1	770 041 206	51	34
•	B	1 1/4	770 041 107	64	45
•	G	1 1/4	770 041 207	64	45
•	B	1 1/2	770 041 108	68	49
•	G	1 1/2	770 041 208	68	49
•	B	2	770 041 109	81	57
•	G	2	770 041 209	81	57
•	B	2 1/2	770 041 110	99	72
•	G	2 1/2	770 041 210	99	72
•	B	3	770 041 111	113	83
•	G	3	770 041 211	113	83
-	G	4	770 041 212	141	105

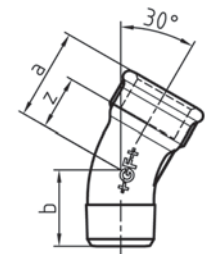

50 Bend 30°

EN	B/G	Code	Dim. [inch]	a [mm]	b [mm]	z [mm]
-	G	770 050 204	1/2	30	24	17
-	G	770 050 205	3/4	36	30	21
-	G	770 050 206	1	44	36	27
-	G	770 050 207	1 1/4	52	44	33
-	G	770 050 208	1 1/2	56	46	37
-	G	770 050 209	2	66	54	42
-	G	770 050 210	2 1/2	80	66	53
-	G	770 050 211	3	92	77	62
-	G	770 050 212	4	114	100	78



51 Bend 30°

EN	B/G	Dim. [inch]	Code	a [mm]	z [mm]
-	G	1/2	770 051 204	30	17
-	G	3/4	770 051 205	36	21
-	G	1	770 051 206	44	27
-	G	1 1/4	770 051 207	52	33
-	G	1 1/2	770 051 208	56	37
-	G	2	770 051 209	66	42

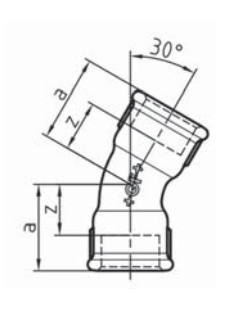

53 Bend 15°

EN	B/G	Code	Dim. [inch]	a [mm]	b [mm]	z [mm]
-	G	770 053 204	1/2	28	21	15
-	G	770 053 205	3/4	33	25	18
-	G	770 053 206	1	37	29	20
-	G	770 053 207	1 1/4	43	34	24
-	G	770 053 208	1 1/2	45	35	26
-	G	770 053 209	2	51	41	27
-	G	770 053 210	2 1/2	62	52	35

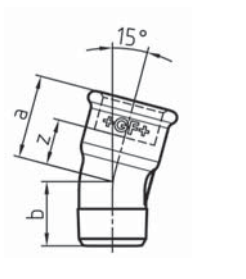

54 Bend 15°

EN	B/G	Dim. [inch]	Code	a [mm]	z [mm]
-	G	1/2	770 054 204	28	15
-	G	3/4	770 054 205	33	18
-	G	1	770 054 206	37	20
-	G	1 1/4	770 054 207	45	26
-	G	1 1/2	770 054 208	47	28
-	G	2	770 054 209	51	27

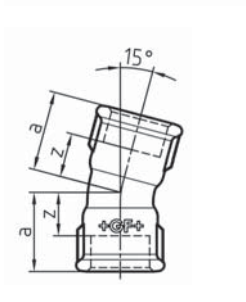

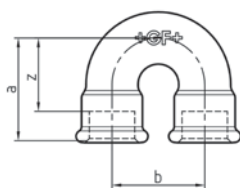

60 Return bend

EN	B/G	Dim. [inch]	Code	a [mm]	b [mm]	z [mm]
-	B	1/2	770 060 104	45	38	32
-	G	1/2	770 060 204	45	38	32
-	B	3/4	770 060 105	52	50	37
-	G	3/4	770 060 205	52	50	37
-	B	1	770 060 106	64	64	47
-	G	1	770 060 206	64	64	47
-	B	1 1/4	770 060 107	73	76	54
-	G	1 1/4	770 060 207	73	76	54
-	B	1 1/2	770 060 108	80	89	61
-	G	1 1/2	770 060 208	80	89	61
-	B	2	770 060 109	90	102	66
-	G	2	770 060 209	90	102	66

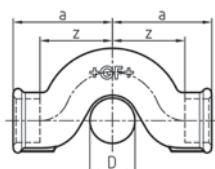

85 Crossover

• * D=3/4

EN	B/G	Dim. [inch]	Code	a [mm]	D [inch]	z [mm]
-	B	3/8	770 085 103	38	3/8	28
-	G	3/8	770 085 203	38	3/8	28
-	B	1/2	770 085 104	47	1/2	34
-	G	1/2	770 085 204	47	1/2	34
* -	B	1/2	770 085 115	49	3/4	36
* -	G	1/2	770 085 215	49	3/4	36
-	B	3/4	770 085 105	55	3/4	40
-	G	3/4	770 085 205	55	3/4	40
-	B	1	770 085 106	70	1	53
-	G	1	770 085 206	70	1	53
-	B	1 1/4	770 085 107	85	1 1/4	66
-	G	1 1/4	770 085 207	85	1 1/4	66

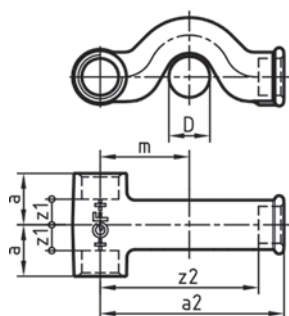

87 Tee with crossover branch

EN	B/G	Dim. [inch]	Code	a [mm]	a2 [mm]	z1 [mm]	z2 [mm]	D [inch]	m [mm]
-	G	1/2	770 087 204	26	93	13	80	1/2	45

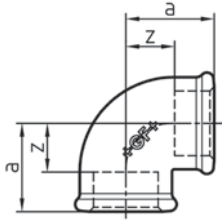

90 Elbow 90°, equal, ISO/EN A1

EN	B/G	Dim. [inch]	Code	a [mm]	z [mm]
•	B	1/8	770 090 101	19	12
•	G	1/8	770 090 201	19	12
•	B	1/4	770 090 102	21	11
•	G	1/4	770 090 202	21	11
•	B	3/8	770 090 103	25	15
•	G	3/8	770 090 203	25	15
•	B	1/2	770 090 104	28	15
•	G	1/2	770 090 204	28	15
•	B	3/4	770 090 105	33	18
•	G	3/4	770 090 205	33	18
•	B	1	770 090 106	38	21
•	G	1	770 090 206	38	21
•	B	1 1/4	770 090 107	45	26
•	G	1 1/4	770 090 207	45	26
•	B	1 1/2	770 090 108	50	31
•	G	1 1/2	770 090 208	50	31
•	B	2	770 090 109	58	34
•	G	2	770 090 209	58	34
•	B	2 1/2	770 090 110	69	42
•	G	2 1/2	770 090 210	69	42
•	B	3	770 090 111	78	48
•	G	3	770 090 211	78	48
•	B	4	770 090 112	96	60
•	G	4	770 090 212	96	60

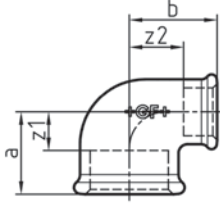

90 Elbow 90°, reducing, ISO/EN A1

EN	B/G	Dim. (1-2) [inch]	Code	a [mm]	b [mm]	z1 [mm]	z2 [mm]
-	B	¼ - ⅛	770 090 115	20	20	10	13
-	G	¼ - ⅛	770 090 215	20	20	10	13
•	B	⅜ - ¼	770 090 116	23	23	13	13
•	G	⅜ - ¼	770 090 216	23	23	13	13
-	B	½ - ¼	770 090 117	24	24	11	14
-	G	½ - ¼	770 090 217	24	24	11	14
•	B	½ - ⅜	770 090 118	26	26	13	16
•	G	½ - ⅜	770 090 218	26	26	13	16
•	B	¾ - ½	770 090 120	30	31	15	18
•	G	¾ - ½	770 090 220	30	31	15	18
-	B	1 - ⅜	770 090 145	32	34	15	24
-	G	1 - ⅜	770 090 245	32	34	15	24
•	B	1 - ½	770 090 121	32	34	15	21
•	G	1 - ½	770 090 221	32	34	15	21
•	B	1 - ¾	770 090 122	35	36	18	21
•	G	1 - ¾	770 090 222	35	36	18	21
-	B	1 ¼ - ½	770 090 132	35	38	16	25
-	G	1 ¼ - ½	770 090 232	35	38	16	25
•	B	1 ¼ - ⅜	770 090 123	36	41	17	26
•	G	1 ¼ - ⅜	770 090 223	36	41	17	26
•	B	1 ¼ - 1	770 090 124	40	42	21	25
•	G	1 ¼ - 1	770 090 224	40	42	21	25
-	B	1 ½ - ⅜	770 090 125	38	44	19	29
-	G	1 ½ - ⅜	770 090 225	38	44	19	29
•	B	1 ½ - 1	770 090 126	42	46	23	29
•	G	1 ½ - 1	770 090 226	42	46	23	29
•	B	1 ½ - 1 ¼	770 090 127	46	48	27	29
•	G	1 ½ - 1 ¼	770 090 227	46	48	27	29
-	B	2 - 1	770 090 128	44	52	20	35
-	G	2 - 1	770 090 228	44	52	20	35
-	B	2 - 1 ¼	770 090 129	48	54	24	35
-	G	2 - 1 ¼	770 090 229	48	54	24	35
•	B	2 - 1 ½	770 090 130	52	55	28	36
•	G	2 - 1 ½	770 090 230	52	55	28	36
•	G	2 ½ - 2	770 090 231	61	66	34	42



92 Elbow 90°, equal, ISO/EN A4

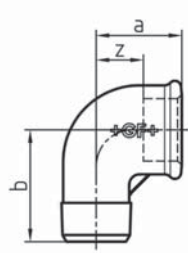

EN	B/G	Dim. [inch]	Code	a [mm]	b [mm]	z [mm]
•	B	1/8	770 092 101	19	25	12
•	G	1/8	770 092 201	19	25	12
•	B	1/4	770 092 102	21	28	11
•	G	1/4	770 092 202	21	28	11
•	B	3/8	770 092 103	25	32	15
•	G	3/8	770 092 203	25	32	15
•	B	1/2	770 092 104	28	37	15
•	G	1/2	770 092 204	28	37	15
•	B	3/4	770 092 105	33	43	18
•	G	3/4	770 092 205	33	43	18
•	B	1	770 092 106	38	52	21
•	G	1	770 092 206	38	52	21
•	B	1 1/4	770 092 107	45	60	26
•	G	1 1/4	770 092 207	45	60	26
•	B	1 1/2	770 092 108	50	65	31
•	G	1 1/2	770 092 208	50	65	31
•	B	2	770 092 109	58	74	34
•	G	2	770 092 209	58	74	34
•	B	2 1/2	770 092 110	69	88	42
•	G	2 1/2	770 092 210	69	88	42
•	B	3	770 092 111	78	98	48
•	G	3	770 092 211	78	98	48
•	B	4	770 092 112	96	118	60
•	G	4	770 092 212	96	118	60



92 Elbow 90°, male thread reduced, ISO/EN A4

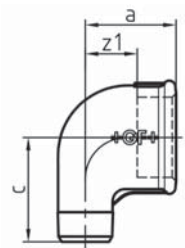

EN	B/G	Dim. (1-2) [inch]	Code	a [mm]	c [mm]	z1 [mm]
•	B	1/2 - 3/8	770 092 116	26	33	13
•	G	1/2 - 3/8	770 092 216	26	33	13
•	B	3/4 - 1/2	770 092 117	30	40	15
•	G	3/4 - 1/2	770 092 217	30	40	15
•	B	1 - 1/2	770 092 130	32	46	15
•	G	1 - 1/2	770 092 230	32	46	15
•	B	1 - 3/4	770 092 118	35	46	18
•	G	1 - 3/4	770 092 218	35	46	18
-	G	1 1/4 - 3/4	770 092 219	44	51	17
•	B	1 1/4 - 1	770 092 120	40	56	21
•	G	1 1/4 - 1	770 092 220	40	56	21
-	B	1 1/2 - 1	770 092 121	47	62	28
-	G	1 1/2 - 1	770 092 221	47	62	28
-	B	1 1/2 - 1 1/4	770 092 122	52	64	33
-	G	1 1/2 - 1 1/4	770 092 222	52	64	33

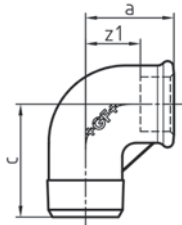

92 Elbow 90°, female thread reduced, ISO/EN A4

EN	B/G	Dim. (1-2) [inch]	Code	a [mm]	c [mm]	z1 [mm]
-	B	3/8 - 1/2	770 092 124	28	37	18
-	G	3/8 - 1/2	770 092 224	28	37	18
-	B	1/2 - 3/4	770 092 125	34	42	21
-	G	1/2 - 3/4	770 092 225	34	42	21
-	B	3/4 - 1	770 092 126	39	50	24
-	G	3/4 - 1	770 092 226	39	50	24
-	B	1 - 1 1/4	770 092 127	44	59	27
-	G	1 - 1 1/4	770 092 227	44	59	27

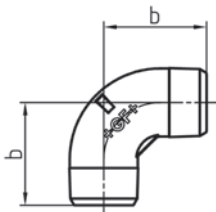

94 Elbow 90°

EN	B/G	Dim. [inch]	Code	b [mm]
-	B	3/8	770 094 103	29
-	G	3/8	770 094 203	29
-	B	1/2	770 094 104	37
-	G	1/2	770 094 204	37
-	B	3/4	770 094 105	40
-	G	3/4	770 094 205	40
-	B	1	770 094 106	47
-	G	1	770 094 206	47
-	B	1 1/4	770 094 107	56
-	G	1 1/4	770 094 207	56
-	B	1 1/2	770 094 108	59
-	G	1 1/2	770 094 208	59
-	B	2	770 094 109	68
-	G	2	770 094 209	68

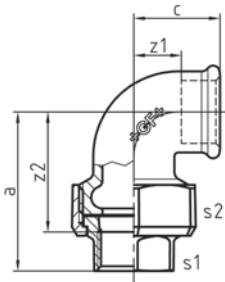

95 Union elbow, flat seat, ISO/EN UA1

- Supplied without sealing gaskets; a and z2 include the seal thickness as per table "Sealing Gasket Dimension".
- 374 G ... refers to the thread size G according to ISO 228 of the union nut 374.
- * Inside hexagon

EN	B/G	Dim. [inch]	374 G [inch]	Code	a [mm]	c [mm]	z1 [mm]	z2 [mm]	s1 [mm]	s2 [mm]
•	B	3/8	3/4	770 095 103	52	25	15	42	*12	32
•	G	3/8	3/4	770 095 203	52	25	15	42	*12	32
•	B	1/2	1	770 095 104	58	28	15	45	26	41
•	G	1/2	1	770 095 204	58	28	15	45	26	41
•	B	3/4	1 1/4	770 095 105	62	33	18	47	31	48
•	G	3/4	1 1/4	770 095 205	62	33	18	47	31	48
•	B	1	1 1/2	770 095 106	72	38	21	55	38	55
•	G	1	1 1/2	770 095 206	72	38	21	55	38	55
•	B	1 1/4	2	770 095 107	82	45	26	63	48	67
•	G	1 1/4	2	770 095 207	82	45	26	63	48	67
•	B	1 1/2	2 1/4	770 095 108	90	50	31	71	54	74
•	G	1 1/2	2 1/4	770 095 208	90	50	31	71	54	74
•	B	2	2 3/4	770 095 109	100	58	34	76	67	90
•	G	2	2 3/4	770 095 209	100	58	34	76	67	90

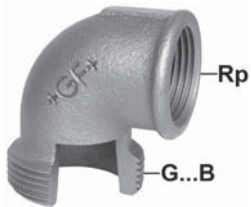

95 ET Union bush to fig. 95

- * Is usually not supplied as a separate piece.

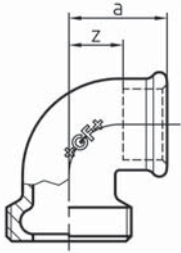

EN	B/G	Dim. Rp [inch]	G...B [inch]	Code	a [mm]	z [mm]
* -	B	3/8	3/4		25	15
* -	G	3/8	3/4		25	15
-	B	1/2	1	770 695 104	28	15
-	G	1/2	1	770 695 204	28	15
-	B	3/4	1 1/4	770 695 105	33	18
-	G	3/4	1 1/4	770 695 205	33	18
-	B	1	1 1/2	770 695 106	38	21
-	G	1	1 1/2	770 695 206	38	21
-	B	1 1/4	2	770 695 107	45	26
-	G	1 1/4	2	770 695 207	45	26
-	B	1 1/2	2 1/4	770 695 108	50	31
-	G	1 1/2	2 1/4	770 695 208	50	31
-	B	2	2 3/4	770 695 109	58	34
-	G	2	2 3/4	770 695 209	58	34



96 Union elbow, taper seat, ISO/EN UA11

- Torque and notes for installation please find in "Technical Product Notes".
- 374 G ... refers to the thread size G according to ISO 228 of the union nut 374.
- * Inside hexagon

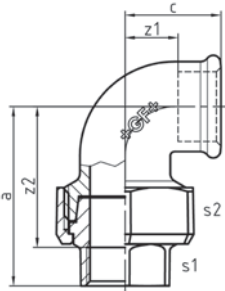

EN	B/G	Dim. [inch]	374 G [inch]	Code	a [mm]	c [mm]	z1 [mm]	z2 [mm]	s1 [mm]	s2 [mm]
•	B	1/4	5/8	770 096 102	48	21	11	38	*10	28
•	G	1/4	5/8	770 096 202	48	21	11	38	*10	28
•	B	3/8	3/4	770 096 103	52	25	15	42	*12	32
•	G	3/8	3/4	770 096 203	52	25	15	42	*12	32
•	B	1/2	1	770 096 104	58	28	15	45	25	41
•	G	1/2	1	770 096 204	58	28	15	45	25	41
•	B	3/4	1 1/4	770 096 105	62	33	18	47	32	48
•	G	3/4	1 1/4	770 096 205	62	33	18	47	32	48
•	B	1	1 1/2	770 096 106	72	38	21	55	38	55
•	G	1	1 1/2	770 096 206	72	38	21	55	38	55
•	B	1 1/4	2	770 096 107	82	45	26	63	48	67
•	G	1 1/4	2	770 096 207	82	45	26	63	48	67
•	B	1 1/2	2 1/4	770 096 108	90	50	31	71	54	74
•	G	1 1/2	2 1/4	770 096 208	90	50	31	71	54	74
•	B	2	2 3/4	770 096 109	100	58	34	76	66	90
•	G	2	2 3/4	770 096 209	100	58	34	76	66	90
-	B	2 1/2	3 1/2	770 096 110	130	72	45	103	85	111
-	G	2 1/2	3 1/2	770 096 210	130	72	45	103	85	111
-	B	3	4	770 096 111	134	79	49	104	96	131
-	G	3	4	770 096 211	134	79	49	104	96	131

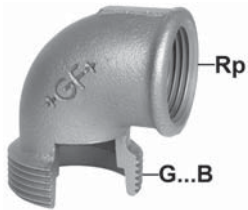

96 ET Union bush to fig. 96

- Is usually not supplied as a separate piece.

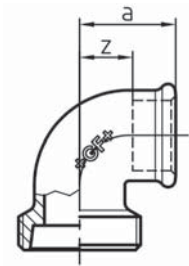

EN	B/G	Dim. Rp [inch]	G...B [inch]	Code	a [mm]	z [mm]
-	B	1/4	5/8		21	11
-	G	1/4	5/8		21	11
-	B	3/8	3/4		25	15
-	G	3/8	3/4		25	15
-	B	1/2	1		28	15
-	G	1/2	1		28	15
-	B	3/4	1 1/4		33	18
-	G	3/4	1 1/4		33	18
-	B	1	1 1/2		38	21
-	G	1	1 1/2		38	21
-	B	1 1/4	2		45	26
-	G	1 1/4	2		45	26
-	B	1 1/2	2 1/4		50	31
-	G	1 1/2	2 1/4		50	31
-	B	2	2 3/4		58	34
-	G	2	2 3/4		58	34
-	B	2 1/2	3 1/2		72	45
-	G	2 1/2	3 1/2		72	45
-	B	3	4		79	49
-	G	3	4		79	49



97 Union elbow, flat seat, ISO/EN UA2

- Supplied without sealing gaskets; b includes the seal thickness as per table "Sealing Gasket Dimension".
- 374 G ... refers to the thread size G according to ISO 228 of the union nut 374.

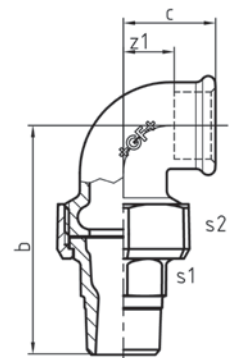

EN	B/G	Dim. [inch]	374 G [inch]	Code	b [mm]	c [mm]	z1 [mm]	s1 [mm]	s2 [mm]
•	B	3/8	3/4	770 097 103	65	25	15	19	32
•	G	3/8	3/4	770 097 203	65	25	15	19	32
•	B	1/2	1	770 097 104	79	28	15	23	41
•	G	1/2	1	770 097 204	79	28	15	23	41
•	B	3/4	1 1/4	770 097 105	82	33	18	30	48
•	G	3/4	1 1/4	770 097 205	82	33	18	30	48
•	B	1	1 1/2	770 097 106	93	38	21	36	55
•	G	1	1 1/2	770 097 206	93	38	21	36	55
•	B	1 1/4	2	770 097 107	107	45	26	48	67
•	G	1 1/4	2	770 097 207	107	45	26	48	67
•	B	1 1/2	2 1/4	770 097 108	115	50	31	54	74
•	G	1 1/2	2 1/4	770 097 208	115	50	31	54	74
•	B	2	2 3/4	770 097 109	128	58	34	66	90
•	G	2	2 3/4	770 097 209	128	58	34	66	90

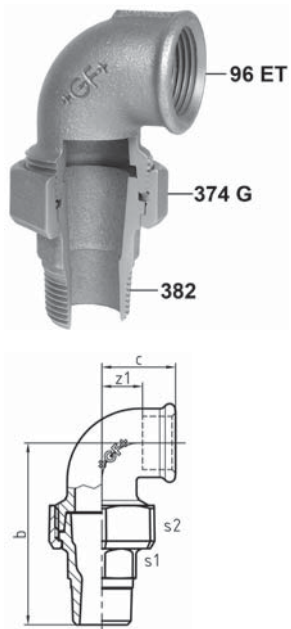

98 Union elbow, taper seat, ISO/EN UA12

- Torque and notes for installation please find in "Technical Product Notes".
- 374 G ... refers to the thread size G according to ISO 228 of the union nut 374.

EN	B/G	Dim. [inch]	374 G [inch]	Code	b [mm]	c [mm]	z1 [mm]	s1 [mm]	s2 [mm]
•	B	1/4	5/8	770 098 102	61	21	11	15	28
•	G	1/4	5/8	770 098 202	61	21	11	15	28
•	B	3/8	3/4	770 098 103	65	25	15	20	32
•	G	3/8	3/4	770 098 203	65	25	15	20	32
•	B	1/2	1	770 098 104	76	28	15	25	41
•	G	1/2	1	770 098 204	76	28	15	25	41
•	B	3/4	1 1/4	770 098 105	82	33	18	32	48
•	G	3/4	1 1/4	770 098 205	82	33	18	32	48
•	B	1	1 1/2	770 098 106	94	38	21	38	55
•	G	1	1 1/2	770 098 206	94	38	21	38	55
•	B	1 1/4	2	770 098 107	107	45	26	48	67
•	G	1 1/4	2	770 098 207	107	45	26	48	67
•	B	1 1/2	2 1/4	770 098 108	115	50	31	54	74
•	G	1 1/2	2 1/4	770 098 208	115	50	31	54	74
•	B	2	2 3/4	770 098 109	128	58	34	67	90
•	G	2	2 3/4	770 098 209	128	58	34	67	90
-	B	2 1/2	3 1/2	770 098 110	164	72	45	85	111
-	G	2 1/2	3 1/2	770 098 210	164	72	45	85	111
-	B	3	4	770 098 111	167	79	49	95	131
-	G	3	4	770 098 211	167	79	49	95	131

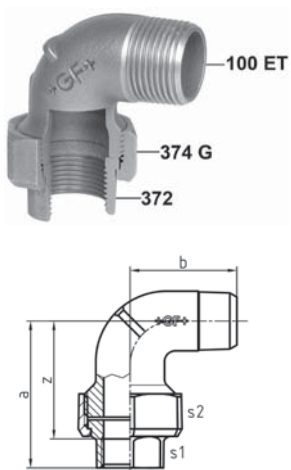

100 Union elbow, flat seat

- Supplied without sealing gaskets; a and z include the seal thickness as per table "Sealing Gasket Dimension".
- 374 G ... refers to the thread size G according to ISO 228 of the union nut 374.

EN	B/G	Dim. [inch]	374 G [inch]	Code	a [mm]	b [mm]	z [mm]	s1 [mm]	s2 [mm]
-	B	1/2	1	770 100 104	58	39	45	26	41
-	G	1/2	1	770 100 204	58	39	45	26	41
-	B	3/4	1 1/4	770 100 105	61	43	46	31	48
-	G	3/4	1 1/4	770 100 205	61	43	46	31	48
-	B	1	1 1/2	770 100 106	71	52	55	38	55
-	G	1	1 1/2	770 100 206	71	52	55	38	55

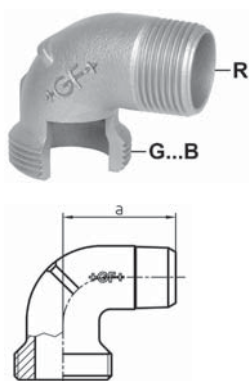

100 ET Union bush to fig. 100/101

EN	B/G	Dim. R [inch]	G...B [inch]	Code	a [mm]
-	B	1/2	1	770 600 104	39
-	G	1/2	1	770 600 204	39
-	B	3/4	1 1/4	770 600 105	43
-	G	3/4	1 1/4	770 600 205	43
-	B	1	1 1/2	770 600 106	52
-	G	1	1 1/2	770 600 206	52

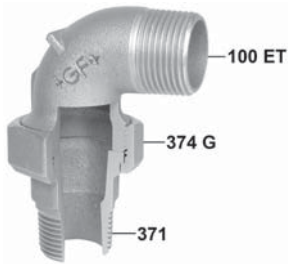

101 Union elbow, flat seat

- Supplied without sealing gaskets; a includes the seal thickness as per table "Sealing Gasket Dimension".
- 374 G ... refers to the thread size G according to ISO 228 of the union nut 374.

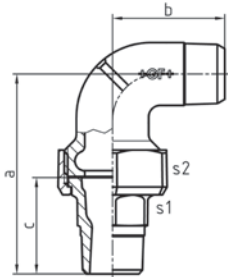

EN	B/G	Dim. [inch]	374 G [inch]	Code	a [mm]	b [mm]	c [mm]	s1 [mm]	s2 [mm]
-	B	1/2	1	770 101 104	77	39	40	23	41
-	G	1/2	1	770 101 204	77	39	40	23	41
-	B	3/4	1 1/4	770 101 105	81	43	42	30	48
-	G	3/4	1 1/4	770 101 205	81	43	42	30	48
-	B	1	1 1/2	770 101 106	93	52	47	36	55
-	G	1	1 1/2	770 101 206	93	52	47	36	55



102 Union elbow, taper seat

- Torque and notes for installation please find in "Technical Product Notes".
- 374 G ... refers to the thread size G according to ISO 228 of the union nut 374.

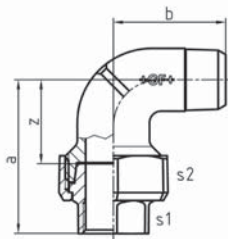

EN	B/G	Dim. [inch]	374 G [inch]	Code	a [mm]	b [mm]	z [mm]	s1 [mm]	s2 [mm]
-	B	1/2	1	770 102 104	59	39	46	25	41
-	G	1/2	1	770 102 204	59	39	46	25	41
-	B	3/4	1 1/4	770 102 105	61	43	46	32	48
-	G	3/4	1 1/4	770 102 205	61	43	46	32	48
-	B	1	1 1/2	770 102 106	71	52	54	38	55
-	G	1	1 1/2	770 102 206	71	52	54	38	55



102 ET Union bush to Fig. 102/103

- Is usually not supplied as a separate piece.

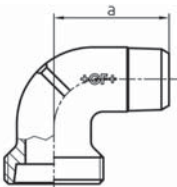

EN	B/G	Dim. R [inch]	G...B [inch]	Code	a [mm]
-	B	1/2	1		39
-	G	1/2	1		39
-	B	3/4	1 1/4		43
-	G	3/4	1 1/4		43
-	B	1	1 1/2		52
-	G	1	1 1/2		52



103 Union elbow, taper seat

- Torque and notes for installation please find in "Technical Product Notes".
- 374 G ... refers to the thread size G according to ISO 228 of the union nut 374.

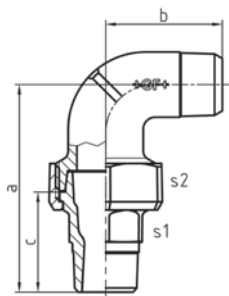

EN	B/G	Dim. [inch]	374 G [inch]	Code	a [mm]	b [mm]	c [mm]	s1 [mm]	s2 [mm]
-	B	1/2	1	770 103 104	76	39	40.5	25	39
-	G	1/2	1	770 103 204	76	39	40.5	25	39
-	B	3/4	1 1/4	770 103 105	81	43	42.5	32	48
-	G	3/4	1 1/4	770 103 205	81	43	42.5	32	48
-	B	1	1 1/2	770 103 106	93	52	47.5	38	55
-	G	1	1 1/2	770 103 206	93	52	47.5	38	55



120 Elbow 45°, ISO/EN A1/45°

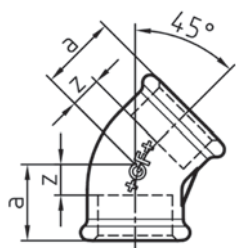

EN	B/G	Dim. [inch]	Code	a [mm]	z [mm]
•	B	3/8	770 120 103	20	10
•	G	3/8	770 120 203	20	10
•	B	1/2	770 120 104	22	9
•	G	1/2	770 120 204	22	9
•	B	3/4	770 120 105	25	10
•	G	3/4	770 120 205	25	10
•	B	1	770 120 106	28	11
•	G	1	770 120 206	28	11
•	B	1 1/4	770 120 107	33	14
•	G	1 1/4	770 120 207	33	14
•	B	1 1/2	770 120 108	36	17
•	G	1 1/2	770 120 208	36	17
•	B	2	770 120 109	43	19
•	G	2	770 120 209	43	19
-	B	2 1/2	770 120 110	48	21
-	G	2 1/2	770 120 210	48	21
-	B	3	770 120 111	54	24
-	G	3	770 120 211	54	24

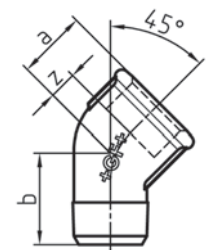

121 Elbow 45°, ISO/EN A4/45°

EN	B/G	Dim. [inch]	Code	a [mm]	b [mm]	z [mm]
•	B	3/8	770 121 103	20	26	10
•	G	3/8	770 121 203	20	26	10
•	B	1/2	770 121 104	22	28	9
•	G	1/2	770 121 204	22	28	9
•	B	3/4	770 121 105	25	32	10
•	G	3/4	770 121 205	25	32	10
•	B	1	770 121 106	28	39	11
•	G	1	770 121 206	28	39	11
•	B	1 1/4	770 121 107	33	43	14
•	G	1 1/4	770 121 207	33	43	14
•	B	1 1/2	770 121 108	36	46	17
•	G	1 1/2	770 121 208	36	46	17
•	B	2	770 121 109	43	55	19
•	G	2	770 121 209	43	55	19
-	B	2 1/2	770 121 110	46	54	19
-	G	2 1/2	770 121 210	46	54	19
-	B	3	770 121 111	52	61	22
-	G	3	770 121 211	52	61	22

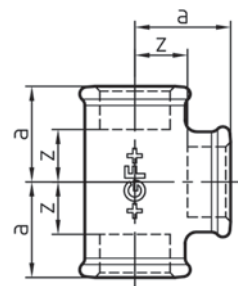

130 Tee, equal, ISO/EN B1

EN	B/G	Dim. [inch]	Code	a [mm]	z [mm]
•	B	1/8	770 130 101	19	12
•	G	1/8	770 130 201	19	12
•	B	1/4	770 130 102	21	11
•	G	1/4	770 130 202	21	11
•	B	3/8	770 130 103	25	15
•	G	3/8	770 130 203	25	15
•	B	1/2	770 130 104	28	15
•	G	1/2	770 130 204	28	15
•	B	3/4	770 130 105	33	18
•	G	3/4	770 130 205	33	18
•	B	1	770 130 106	38	21
•	G	1	770 130 206	38	21
•	B	1 1/4	770 130 107	45	26
•	G	1 1/4	770 130 207	45	26
•	B	1 1/2	770 130 108	50	31
•	G	1 1/2	770 130 208	50	31
•	B	2	770 130 109	58	34
•	G	2	770 130 209	58	34
•	B	2 1/2	770 130 110	69	42
•	G	2 1/2	770 130 210	69	42
•	B	3	770 130 111	78	48
•	G	3	770 130 211	78	48
•	B	4	770 130 112	96	60
•	G	4	770 130 212	96	60

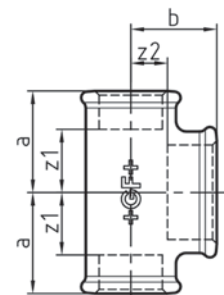
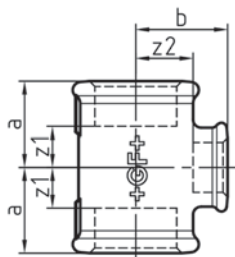

130 Tee, reducing or increasing on the branch, ISO/EN B1

EN	B/G	Dim. (1-2) [inch]	Code	a [mm]	b [mm]	z1 [mm]	z2 [mm]
•	B	3/8 - 1/4	770 130 115	23	23	13	13
•	G	3/8 - 1/4	770 130 215	23	23	13	13
•	B	3/8 - 1/2	770 130 116	26	26	16	13
•	G	3/8 - 1/2	770 130 216	26	26	16	13
•	B	1/2 - 1/4	770 130 117	24	24	11	14
•	G	1/2 - 1/4	770 130 217	24	24	11	14
•	B	1/2 - 3/8	770 130 119	26	26	13	16
•	G	1/2 - 3/8	770 130 219	26	26	13	16
•	B	1/2 - 3/4	770 130 121	31	30	18	15
•	G	1/2 - 3/4	770 130 221	31	30	18	15
•	B	1/2 - 1	770 130 130	34	32	21	15
•	G	1/2 - 1	770 130 230	34	32	21	15
•	B	3/4 - 1/4	770 130 122	26	27	11	17
•	G	3/4 - 1/4	770 130 222	26	27	11	17
•	B	3/4 - 3/8	770 130 124	28	28	13	18
•	G	3/4 - 3/8	770 130 224	28	28	13	18
•	B	3/4 - 1/2	770 130 127	30	31	15	18
•	G	3/4 - 1/2	770 130 227	30	31	15	18
•	B	3/4 - 1	770 130 132	36	35	21	18
•	G	3/4 - 1	770 130 232	36	35	21	18
•	B	1 - 1/4	770 130 133	28	31	11	21
•	G	1 - 1/4	770 130 233	28	31	11	21
•	B	1 - 3/8	770 130 134	30	32	13	22
•	G	1 - 3/8	770 130 234	30	32	13	22
•	B	1 - 1/2	770 130 137	32	34	15	21
•	G	1 - 1/2	770 130 237	32	34	15	21
•	B	1 - 3/4	770 130 140	35	36	18	21
•	G	1 - 3/4	770 130 240	35	36	18	21
•	B	1 - 1 1/4	770 130 145	42	40	25	21
•	G	1 - 1 1/4	770 130 245	42	40	25	21
•	B	1 - 1 1/2	770 130 159	46	42	29	23
•	G	1 - 1 1/2	770 130 259	46	42	29	23
•	B	1 1/4 - 3/8	770 130 146	32	36	13	26
•	G	1 1/4 - 3/8	770 130 246	32	36	13	26
•	B	1 1/4 - 1/2	770 130 148	34	38	15	25
•	G	1 1/4 - 1/2	770 130 248	34	38	15	25
•	B	1 1/4 - 3/4	770 130 151	36	41	17	26
•	G	1 1/4 - 3/4	770 130 251	36	41	17	26
•	B	1 1/4 - 1	770 130 155	40	42	21	25
•	G	1 1/4 - 1	770 130 255	40	42	21	25
•	B	1 1/4 - 1 1/2	770 130 161	48	46	29	27
•	G	1 1/4 - 1 1/2	770 130 261	48	46	29	27
•	B	1 1/4 - 2	770 130 177	54	48	35	24
•	G	1 1/4 - 2	770 130 277	54	48	35	24
-	B	1 1/2 - 3/8	770 130 162	33	38	14	28
-	G	1 1/2 - 3/8	770 130 262	33	38	14	28
•	B	1 1/2 - 1/2	770 130 164	36	42	17	29
•	G	1 1/2 - 1/2	770 130 264	36	42	17	29
•	B	1 1/2 - 3/4	770 130 166	38	44	19	29
•	G	1 1/2 - 3/4	770 130 266	38	44	19	29
•	B	1 1/2 - 1	770 130 169	42	46	23	29
•	G	1 1/2 - 1	770 130 269	42	46	23	29
•	B	1 1/2 - 1 1/4	770 130 172	46	48	27	29
•	G	1 1/2 - 1 1/4	770 130 272	46	48	27	29
•	B	1 1/2 - 2	770 130 179	55	52	36	28
•	G	1 1/2 - 2	770 130 279	55	52	36	28
•	B	2 - 1/2	770 130 181	38	48	14	35
•	G	2 - 1/2	770 130 281	38	48	14	35
•	B	2 - 3/4	770 130 183	40	50	16	35
•	G	2 - 3/4	770 130 283	40	50	16	35
•	B	2 - 1	770 130 185	44	52	20	35
•	G	2 - 1	770 130 285	44	52	20	35
•	B	2 - 1 1/4	770 130 188	48	54	24	35
•	G	2 - 1 1/4	770 130 288	48	54	24	35

table continued next page

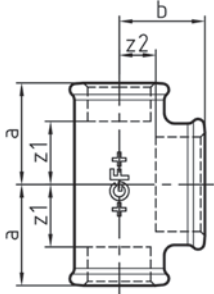
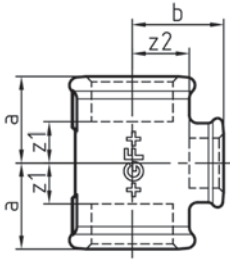

EN	B/G	Dim. (1-2) [inch]	Code	a [mm]	b [mm]	z1 [mm]	z2 [mm]
•	B	2 - 1 1/2	770 130 191	52	55	28	36
•	G	2 - 1 1/2	770 130 291	52	55	28	36
-	B	2 - 2 1/2	770 130 197	66	61	42	34
-	G	2 - 2 1/2	770 130 297	66	61	42	34
-	B	2 1/2 - 1/2	770 130 198	41	56	14	43
-	G	2 1/2 - 1/2	770 130 298	41	56	14	43
-	B	2 1/2 - 3/4	770 130 199	45	59	18	44
-	G	2 1/2 - 3/4	770 130 299	45	59	18	44
•	B	2 1/2 - 1	770 129 115	47	60	20	43
•	G	2 1/2 - 1	770 129 215	47	60	20	43
•	B	2 1/2 - 1 1/4	770 129 116	52	62	25	43
•	G	2 1/2 - 1 1/4	770 129 216	52	62	25	43
•	B	2 1/2 - 1 1/2	770 129 118	55	63	28	44
•	G	2 1/2 - 1 1/2	770 129 218	55	63	28	44
•	B	2 1/2 - 2	770 129 120	61	66	34	42
•	G	2 1/2 - 2	770 129 220	61	66	34	42
-	B	3 - 1/2	770 129 124	46	63	15	50
-	G	3 - 1/2	770 129 224	46	63	15	50
-	B	3 - 3/4	770 129 125	48	66	18	51
-	G	3 - 3/4	770 129 225	48	66	18	51
•	B	3 - 1	770 129 126	51	67	21	50
•	G	3 - 1	770 129 226	51	67	21	50
•	B	3 - 1 1/4	770 129 127	55	70	25	51
•	G	3 - 1 1/4	770 129 227	55	70	25	51
•	B	3 - 1 1/2	770 129 128	58	71	28	52
•	G	3 - 1 1/2	770 129 228	58	71	28	52
•	B	3 - 2	770 129 130	64	73	34	49
•	G	3 - 2	770 129 230	64	73	34	49
•	B	3 - 2 1/2	770 129 131	72	76	42	49
•	G	3 - 2 1/2	770 129 231	72	76	42	49
-	B	4 - 1	770 129 133	56	80	20	63
-	G	4 - 1	770 129 233	56	80	20	63
-	B	4 - 1 1/2	770 129 135	61	84	28	65
-	G	4 - 1 1/2	770 129 235	64	84	28	65
•	B	4 - 2	770 129 136	70	86	34	62
•	G	4 - 2	770 129 236	70	86	34	62
-	G	4 - 2 1/2	770 129 237	77	89	41	62
•	B	4 - 3	770 129 138	84	92	48	62
•	G	4 - 3	770 129 238	84	92	48	62

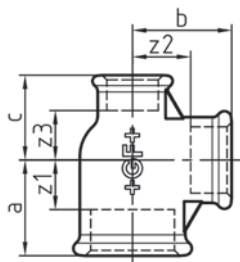

130

Tee, reducing or increasing on the branch, reducing on the run, ISO/EN B1

EN	B/G	Dim. (1-2-3) [inch]	Code	a [mm]	b [mm]	c [mm]	z1 [mm]	z2 [mm]	z3 [mm]
•	B	½ - ¾ - ¾	770 130 118	26	26	25	13	16	15
•	G	½ - ¾ - ¾	770 130 218	26	26	25	13	16	15
•	B	½ - ½ - ¾	770 130 120	28	28	26	15	15	16
•	G	½ - ½ - ¾	770 130 220	28	28	26	15	15	16
•	B	¾ - ¾ - ½	770 130 123	28	28	26	13	18	13
•	G	¾ - ¾ - ½	770 130 223	28	28	26	13	18	13
•	B	¾ - ½ - ¾	770 130 125	30	31	26	15	18	16
•	G	¾ - ½ - ¾	770 130 225	30	31	26	15	18	16
•	B	¾ - ½ - ½	770 130 126	30	31	28	15	18	15
•	G	¾ - ½ - ½	770 130 226	30	31	28	15	18	15
•	B	¾ - ¾ - ¾	770 130 128	33	33	28	18	18	18
•	G	¾ - ¾ - ¾	770 130 228	33	33	28	18	18	18
•	B	¾ - ¾ - ½	770 130 129	33	33	31	18	18	18
•	G	¾ - ¾ - ½	770 130 229	33	33	31	18	18	18
-	B	¾ - 1 - ½	770 130 131	36	35	34	21	18	21
-	G	¾ - 1 - ½	770 130 231	36	35	34	21	18	21
•	B	1 - ½ - ½	770 130 135	32	34	28	15	21	15
•	G	1 - ½ - ½	770 130 235	32	34	28	15	21	15
•	B	1 - ½ - ¾	770 130 136	32	34	30	15	21	15
•	G	1 - ½ - ¾	770 130 236	32	34	30	15	21	15
•	B	1 - ¾ - ½	770 130 138	35	36	31	18	21	18
•	G	1 - ¾ - ½	770 130 238	35	36	31	18	21	18
•	B	1 - ¾ - ¾	770 130 139	35	36	33	18	21	18
•	G	1 - ¾ - ¾	770 130 239	35	36	33	18	21	18
•	B	1 - 1 - ¾	770 130 141	38	38	32	21	21	22
•	G	1 - 1 - ¾	770 130 241	38	38	32	21	21	22
•	B	1 - 1 - ½	770 130 142	38	38	34	21	21	21
•	G	1 - 1 - ½	770 130 242	38	38	34	21	21	21
•	B	1 - 1 - ¾	770 130 143	38	38	36	21	21	21
•	G	1 - 1 - ¾	770 130 243	38	38	36	21	21	21
-	B	1 - 1 ¼ - ¾	770 130 144	42	40	41	25	21	26
-	G	1 - 1 ¼ - ¾	770 130 244	42	40	41	25	21	26
•	B	1 ¼ - ½ - 1	770 130 147	34	38	32	15	25	15
•	G	1 ¼ - ½ - 1	770 130 247	34	38	32	15	25	15
•	B	1 ¼ - ¾ - ¾	770 130 149	36	41	33	17	26	18
•	G	1 ¼ - ¾ - ¾	770 130 249	36	41	33	17	26	18
•	B	1 ¼ - ¾ - 1	770 130 150	36	41	35	17	26	18
•	G	1 ¼ - ¾ - 1	770 130 250	36	41	35	17	26	18
•	B	1 ¼ - 1 - ¾	770 130 153	40	42	36	21	25	21
•	G	1 ¼ - 1 - ¾	770 130 253	40	42	36	21	25	21
•	B	1 ¼ - 1 - 1	770 130 154	40	42	38	21	25	21
•	G	1 ¼ - 1 - 1	770 130 254	40	42	38	21	25	21
•	B	1 ¼ - 1 ¼ - ½	770 130 156	45	45	38	26	26	25
•	G	1 ¼ - 1 ¼ - ½	770 130 256	45	45	38	26	26	25
•	B	1 ¼ - 1 ¼ - ¾	770 130 157	45	45	41	26	26	26
•	G	1 ¼ - 1 ¼ - ¾	770 130 257	45	45	41	26	26	26
•	B	1 ¼ - 1 ¼ - 1	770 130 158	45	45	42	26	26	25
•	G	1 ¼ - 1 ¼ - 1	770 130 258	45	45	42	26	26	25
-	B	1 ¼ - 1 ½ - 1	770 130 160	48	46	46	29	27	29
-	G	1 ¼ - 1 ½ - 1	770 130 260	48	46	46	29	27	29
•	B	1 ½ - ½ - 1 ¼	770 130 163	36	42	34	17	29	15
•	G	1 ½ - ½ - 1 ¼	770 130 263	36	42	34	17	29	15
•	B	1 ½ - ¾ - 1 ¼	770 130 165	38	44	36	19	29	17
•	G	1 ½ - ¾ - 1 ¼	770 130 265	38	44	36	19	29	17
•	B	1 ½ - 1 - 1	770 130 167	42	46	38	23	29	21
•	G	1 ½ - 1 - 1	770 130 267	42	46	38	23	29	21
•	B	1 ½ - 1 - 1 ¼	770 130 168	42	46	38	23	29	21
•	G	1 ½ - 1 - 1 ¼	770 130 268	42	46	38	23	29	21
•	B	1 ½ - 1 ¼ - 1	770 130 170	46	48	42	27	29	25
•	G	1 ½ - 1 ¼ - 1	770 130 270	46	48	42	27	29	25
•	B	1 ½ - 1 ¼ - 1 ¼	770 130 171	46	48	45	27	29	26
•	G	1 ½ - 1 ¼ - 1 ¼	770 130 271	46	48	45	27	29	26
•	B	1 ½ - 1 ½ - ½	770 130 173	50	50	42	31	31	29

table continued next page

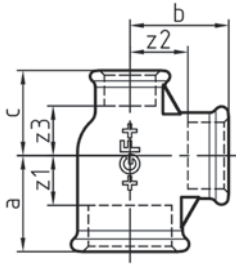

EN	B/G	Dim. (1-2-3) [inch]	Code	a [mm]	b [mm]	c [mm]	z1 [mm]	z2 [mm]	z3 [mm]
•	G	1 ½ - 1 ½ - ½	770 130 273	50	50	42	31	31	29
•	B	1 ½ - 1 ½ - ¾	770 130 174	50	50	44	31	31	29
•	G	1 ½ - 1 ½ - ¾	770 130 274	50	50	44	31	31	29
•	B	1 ½ - 1 ½ - 1	770 130 175	50	50	46	31	31	29
•	G	1 ½ - 1 ½ - 1	770 130 275	50	50	46	31	31	29
•	B	1 ½ - 1 ½ - 1 ¼	770 130 176	50	50	48	31	31	29
•	G	1 ½ - 1 ½ - 1 ¼	770 130 276	50	50	48	31	31	29
-	B	1 ½ - 2 - 1 ¼	770 130 178	56	54	56	37	30	37
-	G	1 ½ - 2 - 1 ¼	770 130 278	56	54	56	37	30	37
-	B	2 - ½ - 1 ½	770 130 180	38	48	38	14	35	19
-	G	2 - ½ - 1 ½	770 130 280	38	48	38	14	35	19
•	B	2 - ¾ - 1 ½	770 130 182	40	50	38	16	35	19
•	G	2 - ¾ - 1 ½	770 130 282	40	50	38	16	35	19
•	B	2 - 1 - 1 ½	770 130 184	44	52	42	20	35	23
•	G	2 - 1 - 1 ½	770 130 284	44	52	42	20	35	23
•	B	2 - 1 ¼ - 1 ¼	770 130 186	48	54	45	24	35	26
•	G	2 - 1 ¼ - 1 ¼	770 130 286	48	54	45	24	35	26
•	B	2 - 1 ¼ - 1 ½	770 130 187	48	54	46	24	35	27
•	G	2 - 1 ¼ - 1 ½	770 130 287	48	54	46	24	35	27
•	B	2 - 1 ½ - 1 ½	770 130 190	52	55	50	28	36	31
•	G	2 - 1 ½ - 1 ½	770 130 290	52	55	50	28	36	31
-	B	2 - 2 - ½	770 130 192	58	58	48	34	34	35
-	G	2 - 2 - ½	770 130 292	58	58	48	34	34	35
•	B	2 - 2 - ¾	770 130 193	58	58	50	34	34	35
•	G	2 - 2 - ¾	770 130 293	58	58	50	34	34	35
•	B	2 - 2 - 1	770 130 194	58	58	52	34	34	35
•	G	2 - 2 - 1	770 130 294	58	58	52	34	34	35
•	B	2 - 2 - 1 ¼	770 130 195	58	58	54	34	34	35
•	G	2 - 2 - 1 ¼	770 130 295	58	58	54	34	34	35
•	B	2 - 2 - 1 ½	770 130 196	58	58	55	34	34	36
•	G	2 - 2 - 1 ½	770 130 296	58	58	55	34	34	36
-	B	2 ½ - 2 - 2	770 129 119	67	72	62	40	48	38
-	G	2 ½ - 2 - 2	770 129 219	67	72	62	40	48	38
-	G	2 ½ - 2 ½ - 1	770 129 221	71	71	71	44	44	54
-	B	2 ½ - 2 ½ - 1 ½	770 129 122	69	69	64	42	42	45
-	G	2 ½ - 2 ½ - 1 ½	770 129 222	69	69	64	42	42	45
-	B	2 ½ - 2 ½ - 2	770 129 123	73	73	68	46	46	34
-	G	2 ½ - 2 ½ - 2	770 129 223	73	73	68	46	46	34
-	G	3 - 2 - 2	770 129 229	64	73	60	34	49	36
-	G	3 - 3 - 2	770 129 232	78	79	72	48	49	48

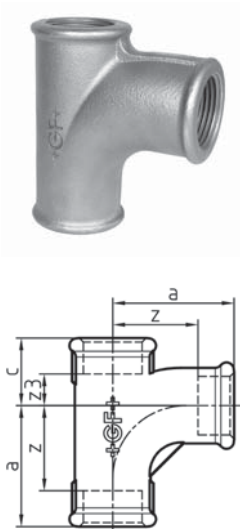

131 Pitcher tee, equal, ISO/EN E1

EN	B/G	Dim. [inch]	Code	a [mm]	c [mm]	z [mm]	z3 [mm]
•	B	½	770 131 104	45	24	32	11
•	G	½	770 131 204	45	24	32	11
•	B	¾	770 131 105	50	28	35	13
•	G	¾	770 131 205	50	28	35	13
•	B	1	770 131 106	63	33	46	16
•	G	1	770 131 206	63	33	46	16
•	B	1 ¼	770 131 107	76	40	57	21
•	G	1 ¼	770 131 207	76	40	57	21
•	B	1 ½	770 131 108	85	43	66	24
•	G	1 ½	770 131 208	85	43	66	24
•	B	2	770 131 109	102	53	78	29
•	G	2	770 131 209	102	53	78	29
-	B	2 ½	770 131 110	115	62	88	35
-	G	2 ½	770 131 210	115	62	88	35
-	B	3	770 131 111	127	70	97	40
-	G	3	770 131 211	127	70	97	40
-	B	4	770 131 112	165	87	129	51
-	G	4	770 131 212	165	87	129	51

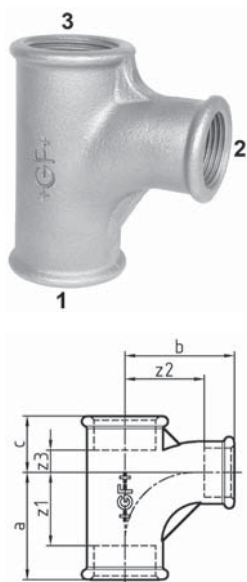

131 Pitcher tee, reducing on the branch, ISO/EN E1

EN	B/G	Dim. (1-2) [inch]	Code	a [mm]	b [mm]	c [mm]	z1 [mm]	z2 [mm]	z3 [mm]
•	B	¾ - ½	770 131 116	47	48	25	32	35	10
•	G	¾ - ½	770 131 216	47	48	25	32	35	10
•	B	1 - ½	770 131 119	49	51	28	32	38	11
•	G	1 - ½	770 131 219	49	51	28	32	38	11
•	B	1 - ¾	770 131 121	53	54	30	36	39	13
•	G	1 - ¾	770 131 221	53	54	30	36	39	13
•	B	1 ¼ - ½	770 131 122	51	56	30	32	43	11
•	G	1 ¼ - ½	770 131 222	51	56	30	32	43	11
•	B	1 ¼ - ¾	770 131 123	55	58	33	36	43	14
•	G	1 ¼ - ¾	770 131 223	55	58	33	36	43	14
•	B	1 ¼ - 1	770 131 125	66	68	36	47	51	17
•	G	1 ¼ - 1	770 131 225	66	68	36	47	51	17
-	B	1 ½ - ½	770 131 140	52	58	29	33	45	10
-	G	1 ½ - ½	770 131 240	52	58	29	33	45	10
•	B	1 ½ - ¾	770 131 126	55	61	33	36	46	14
•	G	1 ½ - ¾	770 131 226	55	61	33	36	46	14
•	B	1 ½ - 1	770 131 127	66	71	36	47	54	17
•	G	1 ½ - 1	770 131 227	66	71	36	47	54	17
•	B	1 ½ - 1 ¼	770 131 128	77	79	41	58	60	22
•	G	1 ½ - 1 ¼	770 131 228	77	79	41	58	60	22
-	B	2 - ½	770 131 137	54	64	32	30	51	8
-	B	2 - ¾	770 131 129	69	75	39	45	60	15
-	G	2 - ¾	770 131 229	69	75	39	45	60	15
•	B	2 - 1	770 131 130	70	77	40	46	60	16
•	G	2 - 1	770 131 230	70	77	40	46	60	16
•	B	2 - 1 ¼	770 131 131	80	85	45	56	66	21
•	G	2 - 1 ¼	770 131 231	80	85	45	56	66	21
•	B	2 - 1 ½	770 131 132	91	94	48	67	75	24
•	G	2 - 1 ½	770 131 232	91	94	48	67	75	24
-	G	2 ½ - 1 ¼	770 131 233	103	108	58	76	89	31
-	B	3 - 2	770 131 135	138	143	69	108	119	39
-	G	3 - 2	770 131 235	138	143	69	108	119	39

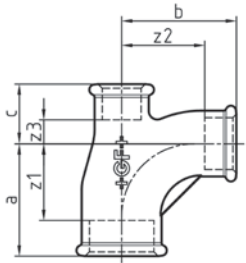

131

Pitcher tee, equal or reducing on the branch and run, ISO/EN E1

EN	B/G	Dim. (1-2-3) [inch]	Code	a [mm]	b [mm]	c [mm]	z1 [mm]	z2 [mm]	z3 [mm]
•	B	$\frac{3}{4}$ - $\frac{1}{2}$ - $\frac{1}{2}$	770 131 115	47	48	24	31	34	11
•	G	$\frac{3}{4}$ - $\frac{1}{2}$ - $\frac{1}{2}$	770 131 215	47	48	24	31	34	11
•	B	$\frac{3}{4}$ - $\frac{3}{4}$ - $\frac{1}{2}$	770 131 117	49	49	27	34	34	14
•	G	$\frac{3}{4}$ - $\frac{3}{4}$ - $\frac{1}{2}$	770 131 217	49	49	27	34	34	14
-	B	1 - $\frac{1}{2}$ - $\frac{3}{4}$	770 131 118	49	51	25	32	38	10
-	G	1 - $\frac{1}{2}$ - $\frac{3}{4}$	770 131 218	49	51	25	32	38	10
•	B	1 - $\frac{3}{4}$ - $\frac{3}{4}$	770 131 120	53	54	28	36	39	13
•	G	1 - $\frac{3}{4}$ - $\frac{3}{4}$	770 131 220	53	54	28	36	39	13

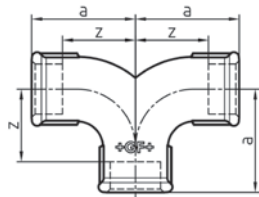

132

Twin elbow, equal, ISO/EN E2

EN	B/G	Dim. [inch]	Code	a [mm]	z [mm]
•	B	$\frac{1}{2}$	770 132 104	45	32
•	G	$\frac{1}{2}$	770 132 204	45	32
•	B	$\frac{3}{4}$	770 132 105	50	35
•	G	$\frac{3}{4}$	770 132 205	50	35
•	B	1	770 132 106	63	46
•	G	1	770 132 206	63	46
•	B	1 $\frac{1}{4}$	770 132 107	76	57
•	G	1 $\frac{1}{4}$	770 132 207	76	57
•	B	1 $\frac{1}{2}$	770 132 108	85	66
•	G	1 $\frac{1}{2}$	770 132 208	85	66
•	B	2	770 132 109	102	78
•	G	2	770 132 209	102	78

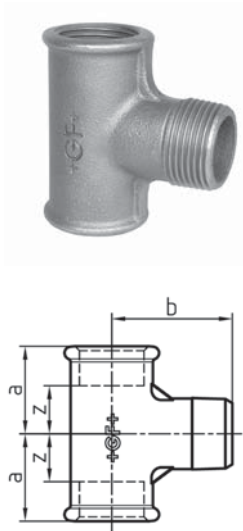

133 Tee, equal

EN	B/G	Dim. [inch]	Code	a [mm]	b [mm]	z [mm]
-	B	3/8	770 133 103	22	31	12
-	G	3/8	770 133 203	22	31	12
-	B	1/2	770 133 104	25	38	12
-	G	1/2	770 133 204	25	38	12
-	B	3/4	770 133 105	33	45	18
-	G	3/4	770 133 205	33	45	18
-	B	1	770 133 106	39	53	22
-	G	1	770 133 206	39	53	22

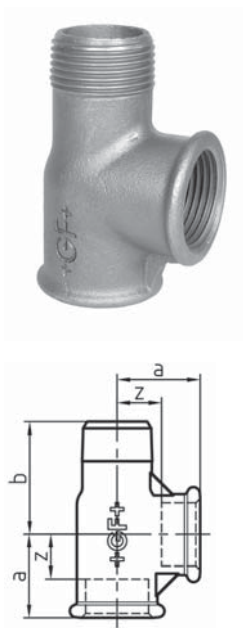

134 Tee, equal

EN	B/G	Dim. [inch]	Code	a [mm]	b [mm]	z [mm]
-	B	1/4	770 134 102	22	28	12
-	G	1/4	770 134 202	22	28	12
-	B	3/8	770 134 103	24	32	14
-	G	3/8	770 134 203	24	32	14
-	B	1/2	770 134 104	27	37	14
-	G	1/2	770 134 204	27	37	14
-	B	3/4	770 134 105	33	43	17
-	G	3/4	770 134 205	33	43	17
-	B	1	770 134 106	37	50	20
-	G	1	770 134 206	37	50	20
-	B	1 1/4	770 134 107	45	58	26
-	G	1 1/4	770 134 207	45	58	26
-	B	1 1/2	770 134 108	50	65	31
-	G	1 1/2	770 134 208	50	65	31
-	B	2	770 134 109	59	69	35
-	G	2	770 134 209	59	69	35

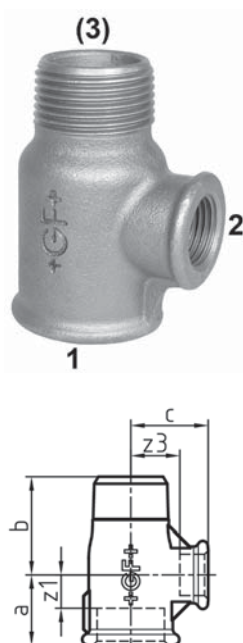

134 Tee, reducing on branch

EN	B/G	Dim. (1-2) [inch]	Code	a [mm]	b [mm]	c [mm]	z1 [mm]	z3 [mm]
-	B	1/2 - 1/4	770 134 116	24	34	24	11	14
-	G	1/2 - 1/4	770 134 216	24	34	24	11	14
-	B	3/4 - 1/2	770 134 118	30	40	30	15	17
-	G	3/4 - 1/2	770 134 218	30	40	30	15	17
-	B	1 - 1/2	770 134 119	32	44	35	15	22
-	G	1 - 1/2	770 134 219	32	44	35	15	22

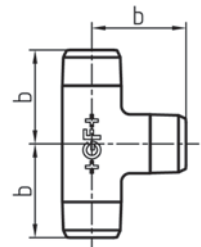

135 Tee, equal

EN	B/G	Dim. [inch]	Code	b [mm]
-	B	1/2	770 135 104	37
-	G	1/2	770 135 204	37
-	B	3/4	770 135 105	43
-	G	3/4	770 135 205	43
-	B	1	770 135 106	48
-	G	1	770 135 206	48

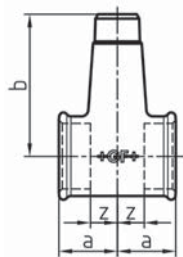

137 Distribution Tee reducing on branch

EN	B/G	Dim. (1-2)	Code	a [mm]	b [mm]	z [mm]
-	G	1 1/4 - 3/4	770 137 216	35	85	16
-	G	1 1/4 - 1	770 137 217	35	75	16
-	G	1 1/2 - 1	770 137 219	40	86	21

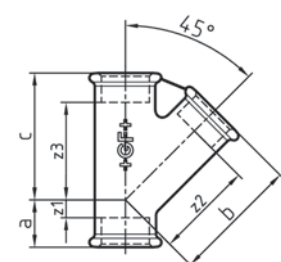

165 Tee 45°, equal

EN	B/G	Dim. [inch]	Code	a [mm]	b [mm]	c [mm]	z1 [mm]	z2 [mm]	z3 [mm]
-	B	3/8	770 165 103	16	46	46	6	36	36
-	B	1/2	770 165 104	23	54	54	10	41	41
-	G	1/2	770 165 204	23	54	54	10	41	41
-	B	3/4	770 165 105	24	64	64	9	49	49
-	G	3/4	770 165 205	24	64	64	9	49	49
-	B	1	770 165 106	28	77	77	11	60	60
-	G	1	770 165 206	28	77	77	11	60	60
-	B	1 1/4	770 165 107	34	91	91	14	72	72
-	G	1 1/4	770 165 207	34	91	91	14	72	72
-	B	1 1/2	770 165 108	34	98	98	15	79	79
-	G	1 1/2	770 165 208	34	98	98	15	79	79
-	B	2	770 165 109	39	115	115	15	91	91
-	G	2	770 165 209	39	115	115	15	91	91



180 Cross, equal, ISO/EN C1

• * Available as long as our stock will last

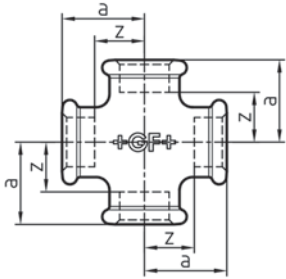

EN	B/G	Dim. [inch]	Code	a [mm]	z [mm]
•	B	1/4	770 180 102	21	11
•	G	1/4	770 180 202	21	11
•	B	3/8	770 180 103	25	15
•	G	3/8	770 180 203	25	15
•	B	1/2	770 180 104	28	15
•	G	1/2	770 180 204	28	15
•	B	3/4	770 180 105	33	18
•	G	3/4	770 180 205	33	18
•	B	1	770 180 106	38	21
•	G	1	770 180 206	38	21
•	B	1 1/4	770 180 107	45	26
•	G	1 1/4	770 180 207	45	26
•	B	1 1/2	770 180 108	50	31
•	G	1 1/2	770 180 208	50	31
•	B	2	770 180 109	58	34
•	G	2	770 180 209	58	34
•	B	2 1/2	770 180 110	69	42
•	G	2 1/2	770 180 210	69	42
•	B	3	770 180 111	78	48
•	G	3	770 180 211	78	48
* •	B	4	770 180 112	96	60
•	G	4	770 180 212	96	60



180 Cross, reducing, ISO/EN C1

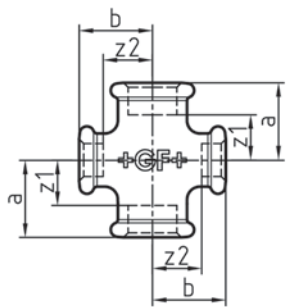

EN	B/G	Dim. (1-2) [inch]	Code	a [mm]	b [mm]	z1 [mm]	z2 [mm]
•	B	3/4 - 1/2	770 180 115	30	31	15	18
•	G	3/4 - 1/2	770 180 215	30	31	15	18
•	B	1 - 1/2	770 180 116	32	34	15	21
•	G	1 - 1/2	770 180 216	32	34	15	21
•	B	1 - 3/4	770 180 117	35	36	18	21
•	G	1 - 3/4	770 180 217	35	36	18	21
•	B	1 1/4 - 1	770 180 118	40	42	21	25
•	G	1 1/4 - 1	770 180 218	40	42	21	25
•	B	1 1/2 - 1	770 180 120	42	46	23	29
•	G	1 1/2 - 1	770 180 220	42	46	23	29
-	B	2 - 1	770 180 121	44	52	20	35
-	G	2 - 1	770 180 221	44	52	20	35

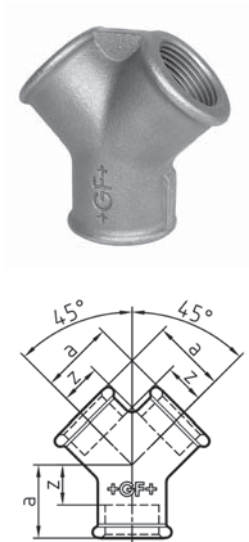

220 Y-piece

EN	B/G	Dim. [inch]	Code	a [mm]	z [mm]
-	B	3/8	770 220 103	24	14
-	G	3/8	770 220 203	24	14
-	B	1/2	770 220 104	27	14
-	G	1/2	770 220 204	27	14
-	B	3/4	770 220 105	33	18
-	G	3/4	770 220 205	33	18
-	B	1	770 220 106	40	23
-	G	1	770 220 206	40	23

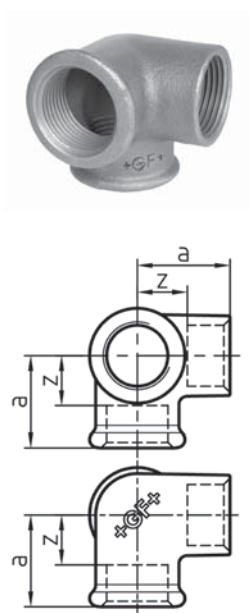

221 Side outlet elbow, ISO/EN Za1

EN	B/G	Dim. [inch]	Code	a [mm]	z [mm]
•	B	3/8	770 221 103	25	15
•	G	3/8	770 221 203	25	15
•	B	1/2	770 221 104	28	15
•	G	1/2	770 221 204	28	15
•	B	3/4	770 221 105	33	18
•	G	3/4	770 221 205	33	18
•	B	1	770 221 106	38	21
•	G	1	770 221 206	38	21
-	B	1 1/4	770 221 107	45	26
-	G	1 1/4	770 221 207	45	26
-	B	1 1/2	770 221 108	50	31
-	G	1 1/2	770 221 208	50	31
-	B	2	770 221 109	58	34
-	G	2	770 221 209	58	34

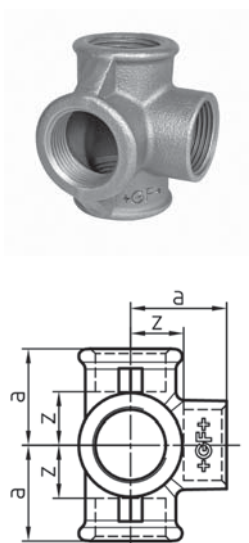

223 Side outlet tee, ISO/EN Za2

EN	B/G	Dim. [inch]	Code	a [mm]	z [mm]
•	B	1/2	770 223 104	28	15
•	G	1/2	770 223 204	28	15
•	B	3/4	770 223 105	33	18
•	G	3/4	770 223 205	33	18
•	B	1	770 223 106	38	21
•	G	1	770 223 206	38	21

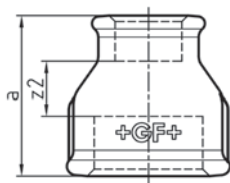

240 Socket, reducing, ISO/EN M2

- ST ... these types of fittings are made from steel (galvanised finish = electroplated) and not suitable for drinking water installations. Steel parts are hexagonal instead of beaded at the end no. 1.

EN	B/G	Dim. (1-2) [inch]	Code	a [mm]	s [mm]	z2 [mm]
ST •	B	¼ - ⅛	770 240 115	27	17	10
ST •	G	¼ - ⅛	770 240 215	27	17	10
ST •	B	⅜ - ⅛	770 240 116	30	22	13
ST •	G	⅜ - ⅛	770 240 216	30	22	13
ST •	B	⅜ - ¼	770 240 117	30	22	10
ST •	G	⅜ - ¼	770 240 217	30	22	10
•	B	½ - ¼	770 240 118	36		13
•	G	½ - ¼	770 240 218	36		13
•	B	½ - ⅜	770 240 119	36		13
•	G	½ - ⅜	770 240 219	36		13
•	B	¾ - ¼	770 240 120	39		14
•	G	¾ - ¼	770 240 220	39		14
•	B	¾ - ⅜	770 240 121	39		14
•	G	¾ - ⅜	770 240 221	39		14
•	B	¾ - ½	770 240 122	39		11
•	G	¾ - ½	770 240 222	39		11
•	B	1 - ⅜	770 240 123	45		18
•	G	1 - ⅜	770 240 223	45		18
•	B	1 - ½	770 240 124	45		15
•	G	1 - ½	770 240 224	45		15
•	B	1 - ¾	770 240 125	45		13
•	G	1 - ¾	770 240 225	45		13
-	B	1 ¼ - ⅜	770 240 126	50		21
-	G	1 ¼ - ⅜	770 240 226	50		21
•	B	1 ¼ - ½	770 240 127	50		18
•	G	1 ¼ - ½	770 240 227	50		18
•	B	1 ¼ - ¾	770 240 128	50		16
•	G	1 ¼ - ¾	770 240 228	50		16
•	B	1 ¼ - 1	770 240 129	50		14
•	G	1 ¼ - 1	770 240 229	50		14
•	B	1 ½ - ½	770 240 130	55		23
•	G	1 ½ - ½	770 240 230	55		23
•	B	1 ½ - ¾	770 240 131	55		21
•	G	1 ½ - ¾	770 240 231	55		21
•	B	1 ½ - 1	770 240 132	55		19
•	G	1 ½ - 1	770 240 232	55		19
•	B	1 ½ - 1 ¼	770 240 133	55		17
•	G	1 ½ - 1 ¼	770 240 233	55		17
•	B	2 - ½	770 240 134	65		28
•	G	2 - ½	770 240 234	65		28
•	B	2 - ¾	770 240 135	65		26
•	G	2 - ¾	770 240 235	65		26
•	B	2 - 1	770 240 136	65		24
•	G	2 - 1	770 240 236	65		24
•	B	2 - 1 ¼	770 240 137	65		22
•	G	2 - 1 ¼	770 240 237	65		22
•	B	2 - 1 ½	770 240 138	65		22
•	G	2 - 1 ½	770 240 238	65		22
-	B	2 ½ - 1	770 240 139	74		30
-	G	2 ½ - 1	770 240 239	74		30
•	B	2 ½ - 1 ½	770 240 141	74		28
•	G	2 ½ - 1 ½	770 240 241	74		28
•	B	2 ½ - 2	770 240 142	74		23
•	G	2 ½ - 2	770 240 242	74		23
-	B	3 - 1 ½	770 240 143	80		31
-	G	3 - 1 ½	770 240 243	80		31
•	B	3 - 2	770 240 144	80		26
•	G	3 - 2	770 240 244	80		26
•	B	3 - 2 ½	770 240 145	80		23
•	G	3 - 2 ½	770 240 245	80		23

table continued next page

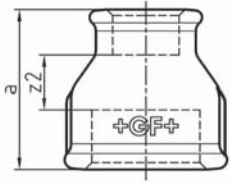

EN	B/G	Dim. (1-2) [inch]	Code	a [mm]	s [mm]	z2 [mm]
•	B	4 - 2	770 240 146	94		34
•	G	4 - 2	770 240 246	94		34
•	B	4 - 2 ½	770 240 147	94		31
•	G	4 - 2 ½	770 240 247	94		31
•	B	4 - 3	770 240 148	94		28
•	G	4 - 3	770 240 248	94		28

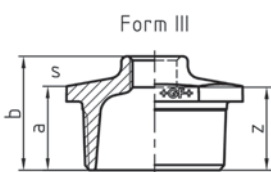
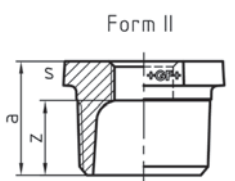
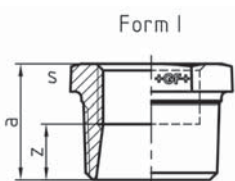

241 Reducing bush, ISO/EN N4

- Forms I, II, III are available only as marked under column "Form", Form I can also be supplied with continuous internal thread (=241D).
- ST ... these types of fittings are made from steel (galvanised finish = electroplated) and not suitable for drinking water installations.

EN	B/G	Dim. (1-2) [inch]	Form	Code	a [mm]	b [mm]	z [mm]	s [mm]
ST •	B	¼ - ⅙	I	770 241 115	20		13	17
ST •	G	¼ - ⅙	I	770 241 215	20		13	17
ST •	B	⅜ - ⅙	I	770 241 116	20		13	19
ST •	G	⅜ - ⅙	I	770 241 216	20		13	19
ST •	B	⅜ - ¼	I	770 241 117	20		10	19
ST •	G	⅜ - ¼	I	770 241 217	20		10	19
•	B	½ - ⅙	II	770 241 118	24		17	23
•	G	½ - ⅙	II	770 241 218	24		17	23
•	B	½ - ¼	II	770 241 119	24		14	23
•	G	½ - ¼	II	770 241 219	24		14	23
•	B	½ - ⅜	I	770 241 120	24		14	23
•	G	½ - ⅜	I	770 241 220	24		14	23
•	B	¾ - ¼	II	770 241 121	26		16	30
•	G	¾ - ¼	II	770 241 221	26		16	30
•	B	¾ - ⅜	II	770 241 122	27		16	30
•	G	¾ - ⅜	II	770 241 222	27		16	30
•	B	¾ - ½	I	770 241 123	26		13	30
•	G	¾ - ½	I	770 241 223	26		13	30
•	B	1 - ¼	II	770 241 124	29		19	36
•	G	1 - ¼	II	770 241 224	29		19	36
•	B	1 - ⅜	II	770 241 125	29		19	36
•	G	1 - ⅜	II	770 241 225	29		19	36
•	B	1 - ½	II	770 241 126	29		16	36
•	G	1 - ½	II	770 241 226	29		16	36
•	B	1 - ⅜	I	770 241 127	29		14	36
•	G	1 - ⅜	I	770 241 227	29		14	36
•	B	1 ¼ - ⅜	II	770 241 128	31		21	46
•	G	1 ¼ - ⅜	II	770 241 228	31		21	46
•	B	1 ¼ - ½	II	770 241 129	31		18	46
•	G	1 ¼ - ½	II	770 241 229	31		18	46
•	B	1 ¼ - ¾	II	770 241 130	31		16	46
•	G	1 ¼ - ¾	II	770 241 230	31		16	46
•	B	1 ¼ - 1	II	770 241 131	31		14	46
•	G	1 ¼ - 1	II	770 241 231	31		14	46
•	B	1 ½ - ⅜	II	770 241 132	31		21	50
•	G	1 ½ - ⅜	II	770 241 232	31		21	50
•	B	1 ½ - ½	II	770 241 133	31		18	50
•	G	1 ½ - ½	II	770 241 233	31		18	50
•	B	1 ½ - ¾	II	770 241 134	31		16	50
•	G	1 ½ - ¾	II	770 241 234	31		16	50
•	B	1 ½ - 1	II	770 241 135	31		14	50
•	G	1 ½ - 1	II	770 241 235	31		14	50
•	B	1 ½ - 1 ¼	I	770 241 136	33		12	50
•	G	1 ½ - 1 ¼	I	770 241 236	33		12	50
•	B	2 - ½	III	770 241 137	35	48	35	65
•	G	2 - ½	III	770 241 237	35	48	35	65
•	B	2 - ¾	III	770 241 138	35	48	33	65
•	G	2 - ¾	III	770 241 238	35	48	33	65
•	B	2 - 1	II	770 241 139	37		20	65
•	G	2 - 1	II	770 241 239	37		20	65
•	B	2 - 1 ¼	II	770 241 140	37		18	65
•	G	2 - 1 ¼	II	770 241 240	37		18	65
•	B	2 - 1 ½	II	770 241 141	37		18	65
•	G	2 - 1 ½	II	770 241 241	37		18	65
•	B	2 ½ - 1	III	770 241 142	44	54	37	80
•	G	2 ½ - 1	III	770 241 242	44	54	37	80
•	B	2 ½ - 1 ¼	III	770 241 143	40	54	37	80
•	G	2 ½ - 1 ¼	III	770 241 243	40	54	37	80
•	B	2 ½ - 1 ½	II	770 241 144	40		21	80

table continued next page

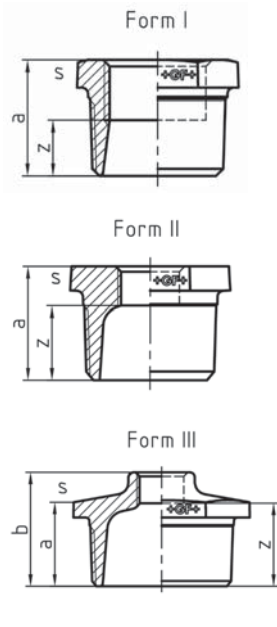

EN	B/G	Dim. (1-2) [inch]	Form	Code	a [mm]	b [mm]	z [mm]	s [mm]
•	G	2 ½ - 1 ½	II	770 241 244	40		21	80
•	B	2 ½ - 2	II	770 241 145	40		16	80
•	G	2 ½ - 2	II	770 241 245	40		16	80
•	B	3 - 1	III	770 241 146	44	59	42	95
•	G	3 - 1	III	770 241 246	44	59	42	95
•	B	3 - 1 ¼	III	770 241 147	44	59	40	95
•	G	3 - 1 ¼	III	770 241 247	44	59	40	95
•	B	3 - 1 ½	III	770 241 148	44	59	40	95
•	G	3 - 1 ½	III	770 241 248	44	59	40	95
•	B	3 - 2	II	770 241 149	44		20	95
•	G	3 - 2	II	770 241 249	44		20	95
•	B	3 - 2 ½	II	770 241 150	44		17	96
•	G	3 - 2 ½	II	770 241 250	44		17	96
•	B	4 - 2	III	770 241 151	51	69	45	120
•	G	4 - 2	III	770 241 251	51	69	45	120
•	B	4 - 2 ½	III	770 241 152	51	69	42	120
•	G	4 - 2 ½	III	770 241 252	51	69	42	120
•	B	4 - 3	II	770 241 153	53		23	120
•	G	4 - 3	II	770 241 253	53		23	120



245 Hexagon nipple, reducing, ISO/EN N8

- ST ... these types of fittings are made from steel (galvanised finish = electroplated) and not suitable for drinking water installations.

EN	B/G	Dim. (1-2) [inch]	Code	a [mm]	s [mm]
ST -	B	¼ - ⅛	770 245 115	35	17
ST -	G	¼ - ⅛	770 245 215	35	17
ST -	B	⅜ - ⅛	770 245 116	34	19
ST -	G	⅜ - ⅛	770 245 216	34	19
ST •	B	⅜ - ¼	770 245 117	38	19
ST •	G	⅜ - ¼	770 245 217	38	19
•	B	½ - ¼	770 245 118	44	27
•	G	½ - ¼	770 245 218	44	27
•	B	½ - ⅜	770 245 119	44	22
•	G	½ - ⅜	770 245 219	44	22
-	B	¾ - ¼	770 245 120	43	30
-	G	¾ - ¼	770 245 220	43	30
•	B	¾ - ⅜	770 245 121	47	30
•	G	¾ - ⅜	770 245 221	47	30
•	B	¾ - ½	770 245 122	47	31
•	G	¾ - ½	770 245 222	47	31
•	B	1 - ½	770 245 123	53	36
•	G	1 - ½	770 245 223	53	36
•	B	1 - ¾	770 245 124	53	36
•	G	1 - ¾	770 245 224	53	36
•	B	1 ¼ - ½	770 245 125	57	46
•	G	1 ¼ - ½	770 245 225	57	46
•	B	1 ¼ - ¾	770 245 126	57	46
•	G	1 ¼ - ¾	770 245 226	57	46
•	B	1 ¼ - 1	770 245 127	57	46
•	G	1 ¼ - 1	770 245 227	57	46
•	B	1 ½ - ¾	770 245 128	59	50
•	G	1 ½ - ¾	770 245 228	59	50
•	B	1 ½ - 1	770 245 129	59	50
•	G	1 ½ - 1	770 245 229	59	50
•	B	1 ½ - 1 ¼	770 245 130	59	50
•	G	1 ½ - 1 ¼	770 245 230	59	50
•	B	2 - 1	770 245 131	68	65
•	G	2 - 1	770 245 231	68	65
•	B	2 - 1 ¼	770 245 132	68	65
•	G	2 - 1 ¼	770 245 232	68	65
•	B	2 - 1 ½	770 245 133	68	65
•	G	2 - 1 ½	770 245 233	68	65
-	B	2 ½ - 1 ½	770 245 134	75	80
-	G	2 ½ - 1 ½	770 245 234	75	80
•	B	2 ½ - 2	770 245 135	75	80
•	G	2 ½ - 2	770 245 235	75	80
•	B	3 - 2	770 245 136	83	95
•	G	3 - 2	770 245 236	83	95
•	B	3 - 2 ½	770 245 137	83	95
•	G	3 - 2 ½	770 245 237	83	95
-	B	4 - 3	770 245 138	96	120
-	G	4 - 3	770 245 238	96	120

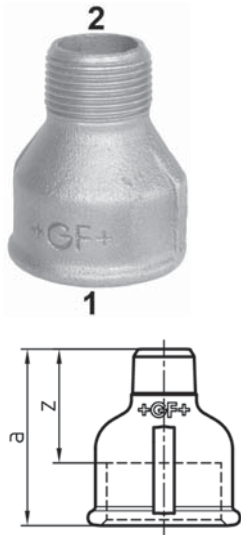

246 Socket, reducing, ISO/EN M4

- ST ... these types of fittings are made from steel (galvanised finish = electroplated) and not suitable for drinking water installations. Steel parts are hexagonal instead of beaded at the end no. 1.

EN	B/G	Dim. (1-2) [inch]	Code	a [mm]	s [mm]	z [mm]
ST -	B	¼ - ⅛	770 246 115	32	17	22
ST -	G	¼ - ⅛	770 246 215	32	17	22
ST •	B	⅜ - ¼	770 246 116	35	22	25
ST •	G	⅜ - ¼	770 246 216	35	22	25
•	B	½ - ¼	770 246 117	43		30
•	G	½ - ¼	770 246 217	43		30
•	B	½ - ⅜	770 246 118	43		30
•	G	½ - ⅜	770 246 218	43		30
•	B	¾ - ⅜	770 246 119	48		33
•	G	¾ - ⅜	770 246 219	48		33
•	B	¾ - ½	770 246 120	48		33
•	G	¾ - ½	770 246 220	48		33
•	B	1 - ½	770 246 121	55		38
•	G	1 - ½	770 246 221	55		38
•	B	1 - ¾	770 246 122	55		38
•	G	1 - ¾	770 246 222	55		38
-	B	1 ¼ - ½	770 246 123	60		41
-	G	1 ¼ - ½	770 246 223	60		41
•	B	1 ¼ - ¾	770 246 124	60		41
•	G	1 ¼ - ¾	770 246 224	60		41
•	B	1 ¼ - 1	770 246 125	60		41
•	G	1 ¼ - 1	770 246 225	60		41
-	B	1 ½ - ¾	770 246 126	60		41
-	G	1 ½ - ¾	770 246 226	60		41
•	B	1 ½ - 1	770 246 127	63		44
•	G	1 ½ - 1	770 246 227	63		44
•	B	1 ½ - 1 ¼	770 246 128	63		44
•	G	1 ½ - 1 ¼	770 246 228	63		44
-	B	2 - 1	770 246 129	70		46
-	G	2 - 1	770 246 229	70		46
•	B	2 - 1 ¼	770 246 130	70		46
•	G	2 - 1 ¼	770 246 230	70		46
•	B	2 - 1 ½	770 246 131	70		46
•	G	2 - 1 ½	770 246 231	70		46
-	B	2 ½ - 1 ½	770 246 132	83		56
-	G	2 ½ - 1 ½	770 246 232	83		56
-	B	2 ½ - 2	770 246 133	80		53
-	G	2 ½ - 2	770 246 233	80		53
-	B	3 - 2	770 246 134	87		57
-	G	3 - 2	770 246 234	87		57
-	B	3 - 2 ½	770 246 135	91		61
-	G	3 - 2 ½	770 246 235	91		61

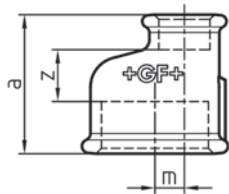

260 Socket eccentric, reducing

EN	B/G	Dim. (1-2) [inch]	Code	a [mm]	z [mm]	m [mm]
-	B	¾ - ½	770 260 122	41	13	3.0
-	G	¾ - ½	770 260 222	41	13	3.0
-	B	1 - ½	770 260 115	45	15	6.0
-	G	1 - ½	770 260 215	45	15	6.0
-	B	1 - ¾	770 260 116	45	13	3.5
-	G	1 - ¾	770 260 216	45	13	3.5
-	B	1 ¼ - ½	770 260 117	50	18	11.0
-	G	1 ¼ - ½	770 260 217	50	18	11.0
-	B	1 ¼ - ¾	770 260 118	50	16	8.0
-	G	1 ¼ - ¾	770 260 218	50	16	8.0
-	B	1 ¼ - 1	770 260 119	50	14	5.0
-	G	1 ¼ - 1	770 260 219	50	14	5.0
-	B	1 ½ - ½	770 260 120	56	24	14.0
-	G	1 ½ - ½	770 260 220	56	24	14.0
-	B	1 ½ - ¾	770 260 123	56	22	11.0
-	G	1 ½ - ¾	770 260 223	56	22	11.0
-	B	1 ½ - 1	770 260 121	56	20	8.0
-	G	1 ½ - 1	770 260 221	56	20	8.0
-	B	1 ½ - 1 ¼	770 260 124	56	18	3.0
-	G	1 ½ - 1 ¼	770 260 224	56	18	3.0
-	B	2 - ½	770 260 125	65	28	20.0
-	G	2 - ½	770 260 225	65	28	20.0
-	B	2 - ¾	770 260 126	65	26	17.0
-	G	2 - ¾	770 260 226	65	26	17.0
-	B	2 - 1	770 260 127	65	24	14.0
-	G	2 - 1	770 260 227	65	24	14.0
-	B	2 - 1 ¼	770 260 128	65	22	10.0
-	G	2 - 1 ¼	770 260 228	65	22	10.0
-	B	2 - 1 ½	770 260 129	65	22	7.0
-	G	2 - 1 ½	770 260 229	65	22	7.0
-	B	2 ½ - 2	770 260 130	74	23	8.0
-	G	2 ½ - 2	770 260 230	74	23	8.0



270 Socket, ISO/EN M2

- ST ... these types of fittings are made from steel (galvanised finish = electroplated) and not suitable for drinking water installations. Steel parts are hexagonal instead of beaded.

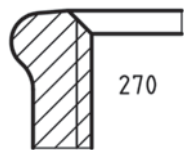
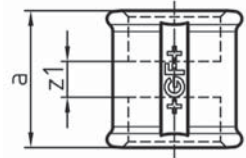

EN	B/G	Dim. [inch]	Code	a [mm]	s [mm]	z1 [mm]
ST •	B	1/8	770 270 101	25	17	11
ST •	G	1/8	770 270 201	25	17	11
ST •	B	1/4	770 270 102	27	19	7
ST •	G	1/4	770 270 202	27	19	7
•	B	3/8	770 270 103	30		10
•	G	3/8	770 270 203	30		10
•	B	1/2	770 270 104	36		10
•	G	1/2	770 270 204	36		10
•	B	3/4	770 270 105	39		9
•	G	3/4	770 270 205	39		9
•	B	1	770 270 106	45		11
•	G	1	770 270 206	45		11
•	B	1 1/4	770 270 107	50		12
•	G	1 1/4	770 270 207	50		12
•	B	1 1/2	770 270 108	55		17
•	G	1 1/2	770 270 208	55		17
•	B	2	770 270 109	65		17
•	G	2	770 270 209	65		17
•	B	2 1/2	770 270 110	74		20
•	G	2 1/2	770 270 210	74		20
•	B	3	770 270 111	80		20
•	G	3	770 270 211	80		20
•	B	4	770 270 112	94		22
•	G	4	770 270 212	94		22



270b Socket, equal

- Is usually not supplied as a separate piece.
- One side with larger chamfer, thread = fastening thread to ISO 228.

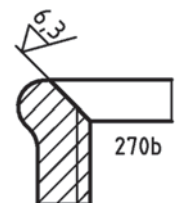
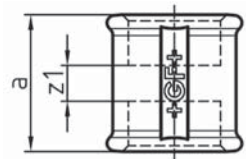

EN	B/G	Dim. [inch]	Code	a [mm]	z1 [mm]
-	G	1/2		36	10
-	G	3/4		39	9
-	G	1		45	11
-	G	1 1/4		50	12
-	G	1 1/2		55	17
-	G	2		65	17



271

Socket, right and left hand thread, ISO/EN M2 R-L

- RT ... right hand thread, LT ... left hand thread

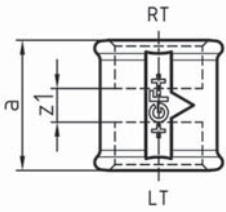

EN	B/G	Dim. [inch]	Code	a [mm]	z1 [mm]
•	B	3/8	770 271 103	30	10
•	G	3/8	770 271 203	30	10
•	B	1/2	770 271 104	36	10
•	G	1/2	770 271 204	36	10
•	B	3/4	770 271 105	39	9
•	G	3/4	770 271 205	39	9
•	B	1	770 271 106	45	11
•	G	1	770 271 206	45	11
•	B	1 1/4	770 271 107	50	12
•	G	1 1/4	770 271 207	50	12
•	B	1 1/2	770 271 108	55	17
•	G	1 1/2	770 271 208	55	17
-	B	2	770 271 109	65	17
-	G	2	770 271 209	65	17

280

Hexagon nipple, ISO/EN N8

- ST ... these types of fittings are made from steel (galvanised finish = electroplated) and not suitable for drinking water installations.

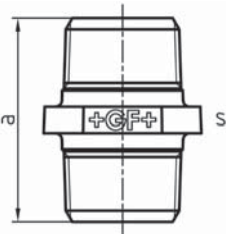

EN	B/G	Dim. [inch]	Code	a [mm]	s [mm]
ST •	B	1/8	770 280 101	29	17
ST •	G	1/8	770 280 201	29	17
ST •	B	1/4	770 280 102	36	19
ST •	G	1/4	770 280 202	36	19
•	B	3/8	770 280 103	38	22
•	G	3/8	770 280 203	38	22
•	B	1/2	770 280 104	44	28
•	G	1/2	770 280 204	44	28
•	B	3/4	770 280 105	47	33
•	G	3/4	770 280 205	47	33
•	B	1	770 280 106	53	42
•	G	1	770 280 206	53	42
•	B	1 1/4	770 280 107	57	50
•	G	1 1/4	770 280 207	57	50
•	B	1 1/2	770 280 108	59	55
•	G	1 1/2	770 280 208	59	55
•	B	2	770 280 109	68	70
•	G	2	770 280 209	68	70
•	B	2 1/2	770 280 110	75	85
•	G	2 1/2	770 280 210	75	85
•	B	3	770 280 111	83	100
•	G	3	770 280 211	83	100
•	B	4	770 280 112	95	131
•	G	4	770 280 212	95	131



281

Hexagon nipple, right and left hand thread, ISO/EN N8 R-L

- RT ... right hand thread, LT ... left hand thread

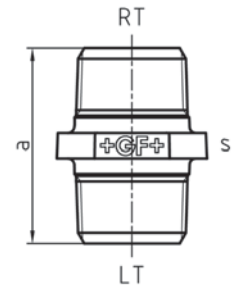

EN	B/G	Dim. [inch]	Code	a [mm]	s [mm]
-	G	3/8	770 281 203	38	22
•	B	1/2	770 281 104	44	28
•	G	1/2	770 281 204	44	28
•	B	3/4	770 281 105	47	33
•	G	3/4	770 281 205	47	33
•	B	1	770 281 106	53	42
•	G	1	770 281 206	53	42
-	B	1 1/4	770 281 107	57	50
-	G	1 1/4	770 281 207	57	50
-	B	1 1/2	770 281 108	59	55
-	G	1 1/2	770 281 208	59	55
-	B	2	770 281 109	68	70
-	G	2	770 281 209	68	70



290

Plug, beaded, ISO/EN T9

- ST ... these types of fittings are made from steel (galvanised finish = electroplated) and not suitable for drinking water installations.
- * Solid

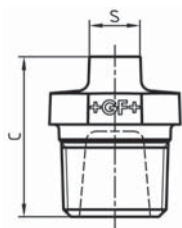

EN	B/G	Dim. [inch]	Code	c [mm]	s [mm]
*ST •	B	1/8	770 290 101	20	7
*ST •	G	1/8	770 290 201	20	7
*ST •	B	1/4	770 290 102	24	8
*ST •	G	1/4	770 290 202	24	8
•	B	3/8	770 290 103	28	10
•	G	3/8	770 290 203	28	10
•	B	1/2	770 290 104	32	11
•	G	1/2	770 290 204	32	11
•	B	3/4	770 290 105	37	17
•	G	3/4	770 290 205	37	17
•	B	1	770 290 106	41	19
•	G	1	770 290 206	41	19
•	B	1 1/4	770 290 107	47	22
•	G	1 1/4	770 290 207	47	22
•	B	1 1/2	770 290 108	47	22
•	G	1 1/2	770 290 208	47	22
•	B	2	770 290 109	54	27
•	G	2	770 290 209	54	27
•	B	2 1/2	770 290 110	64	32
•	G	2 1/2	770 290 210	64	32
•	B	3	770 290 111	71	36
•	G	3	770 290 211	71	36
•	B	4	770 290 112	81	41
•	G	4	770 290 212	81	41



291 Plug, plain, ISO/EN T8

- ST ... these types of fittings are made from steel (galvanised finish = electroplated) and not suitable for drinking water installations. Steel parts are made solid.

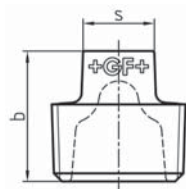

EN	B/G	Dim. [inch]	Code	b [mm]	s [mm]
ST •	B	1/8	770 291 101	16	7
ST •	G	1/8	770 291 201	16	7
ST •	B	1/4	770 291 102	18	8
ST •	G	1/4	770 291 202	18	8
ST •	B	3/8	770 291 103	20	10
ST •	G	3/8	770 291 203	20	10
•	B	1/2	770 291 104	24	11
•	G	1/2	770 291 204	24	11
•	B	3/4	770 291 105	26	17
•	G	3/4	770 291 205	26	17
•	B	1	770 291 106	33	19
•	G	1	770 291 206	33	19
•	B	1 1/4	770 291 107	36	22
•	G	1 1/4	770 291 207	36	22
•	B	1 1/2	770 291 108	37	22
•	G	1 1/2	770 291 208	37	22
•	B	2	770 291 109	44	27
•	G	2	770 291 209	44	27
•	B	2 1/2	770 291 110	52	32
•	G	2 1/2	770 291 210	52	32
•	B	3	770 291 111	59	36
•	G	3	770 291 211	59	36
•	B	4	770 291 112	66	41
•	G	4	770 291 212	66	41



291a Plug, plain, solid

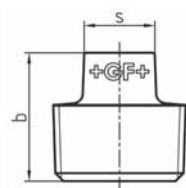

EN	B/G	Dim. [inch]	Code	b [mm]	s [mm]
-	B	3/4	770 292 105	28	17
-	G	3/4	770 292 205	28	17
-	B	1	770 292 106	33	19
-	G	1	770 292 206	33	19
-	B	1 1/4	770 292 107	36	22
-	G	1 1/4	770 292 207	36	22
-	B	1 1/2	770 292 108	38	23
-	G	1 1/2	770 292 208	38	23
-	B	2	770 292 109	44	27
-	G	2	770 292 209	44	27

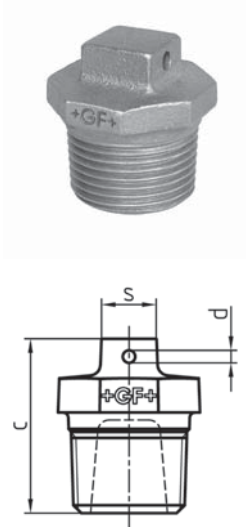

294 Plug, with hole in square head

EN	B/G	Dim. [inch]	Code	c [mm]	s [mm]	d [mm]
-	B	1/2	770 294 104	32	11	4
-	G	1/2	770 294 204	32	11	4
-	B	3/4	770 294 105	37	17	4
-	G	3/4	770 294 205	37	17	4
-	B	1	770 294 106	41	19	5
-	G	1	770 294 206	41	19	5
-	B	1 1/4	770 294 107	47	22	5
-	G	1 1/4	770 294 207	47	22	5
-	B	1 1/2	770 294 108	47	22	5
-	G	1 1/2	770 294 208	47	22	5
-	B	2	770 294 109	54	27	5
-	G	2	770 294 209	54	27	5

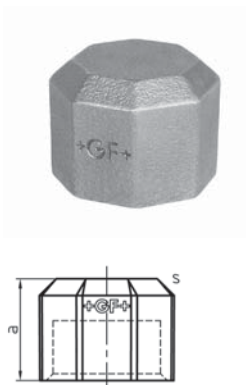

300 Cap, ISO/EN T1

- ST ... these types of fittings are made from steel (galvanised finish = electroplated) and not suitable for drinking water installations.

EN	B/G	Dim. [inch]	Code	a [mm]	s [mm]	Shape
ST •	B	1/8	770 300 101	14	14	hexagon
ST •	G	1/8	770 300 201	14	14	hexagon
ST •	B	1/4	770 300 102	17	17	hexagon
ST •	G	1/4	770 300 202	17	17	hexagon
ST •	B	3/8	770 300 103	18	22	hexagon
ST •	G	3/8	770 300 203	18	22	hexagon
•	B	1/2	770 300 104	24	26	hexagon
•	G	1/2	770 300 204	24	26	hexagon
•	B	3/4	770 300 105	26	32	hexagon
•	G	3/4	770 300 205	26	32	hexagon
•	B	1	770 300 106	29	38	octagon
•	G	1	770 300 206	29	38	octagon
•	B	1 1/4	770 300 107	34	47	octagon
•	G	1 1/4	770 300 207	34	47	octagon
•	B	1 1/2	770 300 108	34	53	octagon
•	G	1 1/2	770 300 208	34	53	octagon
•	B	2	770 300 109	39	68	octagon
•	G	2	770 300 209	39	68	octagon
•	B	2 1/2	770 300 110	44	86	octagon
•	G	2 1/2	770 300 210	44	86	octagon
•	B	3	770 300 111	50	96	octagon
•	G	3	770 300 211	50	96	octagon
•	B	4	770 300 112	54	128	octagon
•	G	4	770 300 212	54	128	octagon

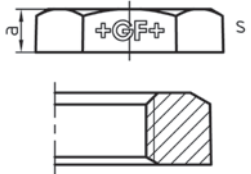

310 Backnut, ISO/EN P4

• ST ... these types of fittings are made from steel (galvanised finish = electroplated).

EN	B/G	G...B [inch]	Code	a [mm]	s [mm]
ST •	B	1/8	770 310 101	7.0	19
ST •	G	1/8	770 310 201	7.0	19
ST •	B	1/4	770 310 102	7.5	22
ST •	G	1/4	770 310 202	7.5	22
ST •	B	3/8	770 310 103	8.0	27
ST •	G	3/8	770 310 203	8.0	27
•	B	1/2	770 310 104	9.0	32
•	G	1/2	770 310 204	9.0	32
•	B	3/4	770 310 105	10.0	36
•	G	3/4	770 310 205	10.0	36
•	B	1	770 310 106	11.5	46
•	G	1	770 310 206	11.5	46
•	B	1 1/4	770 310 107	13.0	56
•	G	1 1/4	770 310 207	13.0	56
•	B	1 1/2	770 310 108	14.0	60
•	G	1 1/2	770 310 208	14.0	60
•	B	2	770 310 109	16.0	73
•	G	2	770 310 209	16.0	73
•	B	2 1/2	770 310 110	19.0	95
•	G	2 1/2	770 310 210	19.0	95
•	B	3	770 310 111	22.0	105
•	G	3	770 310 211	22.0	105

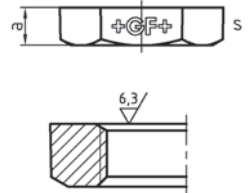

310a Backnut, with one machined face, ISO/EN P4

EN	B/G	G...B [inch]	Code	a [mm]	s [mm]
•	B	1/2	770 309 104	8.5	32
•	G	1/2	770 309 204	8.5	32
•	B	3/4	770 309 105	9.5	36
•	G	3/4	770 309 205	9.5	36
•	B	1	770 309 106	11.5	46
•	G	1	770 309 206	11.5	46
•	B	1 1/4	770 309 107	12.5	56
•	G	1 1/4	770 309 207	12.5	56
•	B	1 1/2	770 309 108	13.5	60
•	G	1 1/2	770 309 208	13.5	60
•	B	2	770 309 109	15.5	73
•	G	2	770 309 209	15.5	73

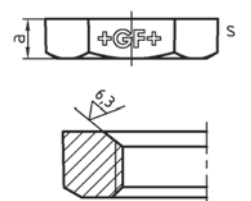

310b Backnut, strongly faced on one end, ISO/EN P4

EN	B/G	G...B [inch]	Code	a [mm]	s [mm]
•	G	1/2	770 308 204	9.0	32
•	G	3/4	770 308 205	10.0	36
•	G	1	770 308 206	11.5	46
•	G	1 1/4	770 308 207	13.0	56
•	G	1 1/2	770 308 208	14.0	60
•	G	2	770 308 209	16.0	73

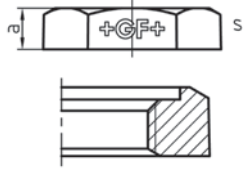

312 Backnut, recessed, ISO/EN P4

• ST ... these types of fittings are made from steel (galvanised finish = electroplated).

EN	B/G	G...B [inch]	Code	a [mm]	s [mm]
ST •	B	¼	770 312 102	7.5	22
ST •	G	¼	770 312 202	7.5	22
ST •	B	⅜	770 312 103	8.0	27
ST •	G	⅜	770 312 203	8.0	27
•	B	½	770 312 104	9.0	32
•	G	½	770 312 204	9.0	32
•	B	¾	770 312 105	10.0	37
•	G	¾	770 312 205	10.0	37
•	B	1	770 312 106	12.0	46
•	G	1	770 312 206	12.0	46
•	B	1 ¼	770 312 107	13.0	55
•	G	1 ¼	770 312 207	13.0	55
•	B	1 ½	770 312 108	14.0	60
•	G	1 ½	770 312 208	14.0	60
•	B	2	770 312 109	16.0	73
•	G	2	770 312 209	16.0	73

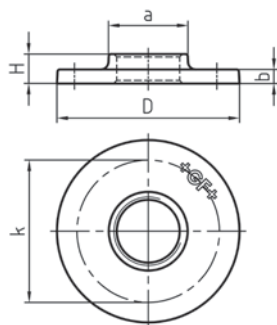

321 Screwed flange, undrilled

EN	B/G	Dim. [inch]	PN	Code	a [mm]	b [mm]	k [mm]	H [mm]	D [mm]
-	B	½	PN 1	770 320 104	28	5	55	13	80
-	G	½	PN 1	770 320 204	28	5	55	13	80
-	B	¾	PN 1	770 320 105	38	6	65	14	90
-	G	¾	PN 1	770 320 205	38	6	65	14	90
-	B	1	PN 1	770 320 106	47	9	75	17	100
-	G	1	PN 1	770 320 206	47	9	75	17	100
-	B	1 ¼	PN 1	770 320 107	51	10	90	21	120
-	G	1 ¼	PN 1	770 320 207	51	10	90	21	120
-	B	1 ½	PN 1	770 320 108	56	10	100	21	130
-	G	1 ½	PN 1	770 320 208	56	10	100	21	130
-	B	2	PN 1	770 320 109	68	11	110	22	140
-	G	2	PN 1	770 320 209	68	11	110	22	140

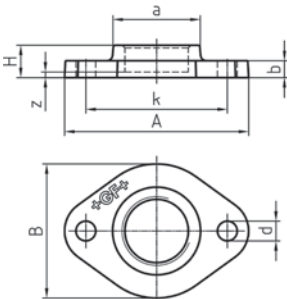

326 Screwed flange, drilled, 2 holes

EN	B/G	Dim. [inch]	PN	Code	a [mm]	b [mm]	d [mm]	k [mm]	z [mm]	A [mm]	B [mm]	H [mm]
-	B	½	PN 10	770 326 104	32	11	11.5	55	4	80	45	17
-	G	½	PN 10	770 326 204	32	11	11.5	55	4	80	45	17
-	B	¾	PN 10	770 326 105	38	11	11.5	65	4	90	64	19
-	G	¾	PN 10	770 326 205	38	11	11.5	65	4	90	64	19
-	B	1	PN 10	770 326 106	46	11	11.5	75	3	100	72	20
-	G	1	PN 10	770 326 206	46	11	11.5	75	3	100	72	20
-	B	1 ¼	PN 10	770 326 107	56	12	14.0	90	3	120	85	22
-	G	1 ¼	PN 10	770 326 207	56	12	14.0	90	3	120	85	22
-	B	1 ½	PN 10	770 326 108	63	13	14.0	100	4	130	95	23
-	G	1 ½	PN 10	770 326 208	63	13	14.0	100	4	130	95	23
-	B	2	PN 10	770 326 109	77	13	14.0	110	0	140	100	24
-	G	2	PN 10	770 326 209	77	13	14.0	110	0	140	100	24



329 Screwed flange, drilled, 4 holes

- Diameter of pitch circle and sealing face compatible to EN 1092-2 and DIN 2566.
- * 8 holes

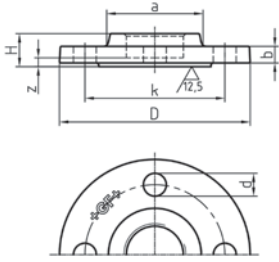

EN	B/G	Dim. [inch]	PN	Code	a [mm]	b [mm]	d [mm]	k [mm]	z [mm]	H [mm]	D [mm]
-	B	1/2	PN 16	770 329 104	35	14	14	65	7	20	95
-	G	1/2	PN 16	770 329 204	35	14	14	65	7	20	95
-	B	3/4	PN 16	770 329 105	45	16	14	75	9	24	105
-	G	3/4	PN 16	770 329 205	45	16	14	75	9	24	105
-	B	1	PN 16	770 329 106	52	17	14	85	7	24	115
-	G	1	PN 16	770 329 206	52	17	14	85	7	24	115
-	B	1 1/4	PN 16	770 329 107	60	17	19	100	7	26	140
-	G	1 1/4	PN 16	770 329 207	60	17	19	100	7	26	140
-	B	1 1/2	PN 16	770 329 108	72	13	19	110	8	26	150
-	G	1 1/2	PN 16	770 329 208	72	13	19	110	8	26	150
-	B	2	PN 16	770 329 109	87	16	19	125	5	29	165
-	G	2	PN 16	770 329 209	87	16	19	125	5	29	165
-	B	2 1/2	PN 16	770 329 110	100	16	19	145	5	32	185
-	G	2 1/2	PN 16	770 329 210	100	16	19	145	5	32	185
-	B	3	PN 10	770 329 111	115	18	19	160	6	36	200
-	G	3	PN 10	770 329 211	115	18	19	160	6	36	200
*	B	3	PN 16	770 329 115	115	18	19	160	6	36	200
*	G	3	PN 16	770 329 215	115	18	19	160	6	36	200
*	B	4	PN 16	770 329 112	140	20	19	180	2	38	220
*	G	4	PN 16	770 329 212	140	20	19	180	2	38	220

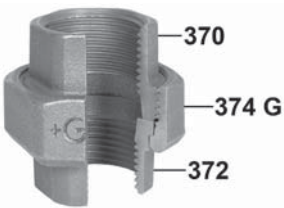

330 Union flat seat, ISO/EN U1

- Supplied without sealing gaskets; a and z1 include the seal thickness as per table "Sealing Gasket Dimension".
- 374 G ... refers to the thread size G according to ISO 228 of the union nut 374.
- * Inside hexagon

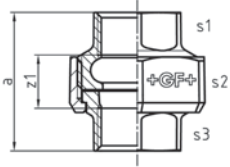

EN	B/G	Dim. [inch]	374 G [inch]	Code	a [mm]	z1 [mm]	s1 [mm]	s2 [mm]	s3 [mm]
•	B	1/4	5/8	770 330 102	42	22	19	28	*10
•	G	1/4	5/8	770 330 202	42	22	19	28	*10
•	B	3/8	3/4	770 330 103	47	27	22	32	*12
•	G	3/8	3/4	770 330 203	47	27	22	32	*12
•	B	1/2	1	770 330 104	48	22	26	41	26
•	G	1/2	1	770 330 204	48	22	26	41	26
•	B	3/4	1 1/4	770 330 105	52	22	31	48	31
•	G	3/4	1 1/4	770 330 205	52	22	31	48	31
•	B	1	1 1/2	770 330 106	59	25	38	55	38
•	G	1	1 1/2	770 330 206	59	25	38	55	38
•	B	1 1/4	2	770 330 107	65	27	48	67	48
•	G	1 1/4	2	770 330 207	65	27	48	67	48
•	B	1 1/2	2 1/4	770 330 108	70	32	54	74	54
•	G	1 1/2	2 1/4	770 330 208	70	32	54	74	54
•	B	2	2 3/4	770 330 109	80	32	66	90	66
•	G	2	2 3/4	770 330 209	80	32	66	90	66
•	B	2 1/2	3 1/2	770 330 110	85	31	85	111	85
•	G	2 1/2	3 1/2	770 330 210	85	31	85	111	85
•	B	3	4	770 330 111	96	36	96	130	96
•	G	3	4	770 330 211	96	36	96	130	96
-	B	4	5	770 330 112	111	39	120	151	122
-	G	4	5	770 330 212	111	39	120	151	122

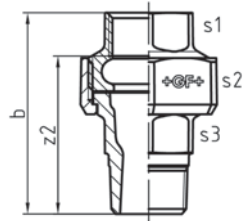
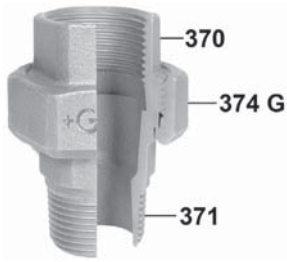

331 Union flat seat, ISO/EN U2

- Supplied without sealing gaskets; b and z2 include the seal thickness as per table "Sealing Gasket Dimension".
- 374 G ... refers to the thread size G according to ISO 228 of the union nut 374.

EN	B/G	Dim. [inch]	374 G [inch]	Code	b [mm]	z2 [mm]	s1 [mm]	s2 [mm]	s3 [mm]
•	B	¼	⅝	770 331 102	55	45	19	28	15
•	G	¼	⅝	770 331 202	55	45	19	28	15
•	B	⅜	¾	770 331 103	58	48	22	32	19
•	G	⅜	¾	770 331 203	58	48	22	32	19
•	B	½	1	770 331 104	66	53	26	41	23
•	G	½	1	770 331 204	66	53	26	41	23
•	B	¾	1 ¼	770 331 105	72	57	31	48	30
•	G	¾	1 ¼	770 331 205	72	57	31	48	30
•	B	1	1 ½	770 331 106	80	63	38	55	36
•	G	1	1 ½	770 331 206	80	63	38	55	36
•	B	1 ¼	2	770 331 107	90	71	48	67	48
•	G	1 ¼	2	770 331 207	90	71	48	67	48
•	B	1 ½	2 ¼	770 331 108	95	76	54	74	54
•	G	1 ½	2 ¼	770 331 208	95	76	54	74	54
•	B	2	2 ¾	770 331 109	107	83	66	90	66
•	G	2	2 ¾	770 331 209	107	83	66	90	66
-	B	2 ½	3 ½	770 331 110	118	91	85	111	85
-	G	2 ½	3 ½	770 331 210	118	91	85	111	85
-	B	3	4	770 331 111	131	101	96	130	95
-	G	3	4	770 331 211	131	101	96	130	95

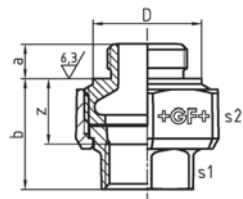
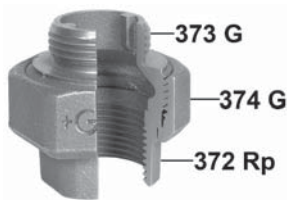

332 Union flat seat

- Supplied without sealing gaskets; b and z include the seal thickness as per table "Sealing Gasket Dimension".
- 374 G ... refers to the thread size G according to ISO 228 of the union nut 374.

EN	B/G	Dim. Rp/G [inch]	374 G [inch]	Code	a [mm]	b [mm]	z [mm]	s1 [mm]	s2 [mm]	D [mm]	
-	B		¾	1 ¼	770 332 105	12	39	24	31	48	36
-	G		¾	1 ¼	770 332 205	12	39	24	31	48	36
-	B		1	1 ½	770 332 106	14	42	25	38	55	43
-	G		1	1 ½	770 332 206	14	42	25	38	55	43
-	B		1 ¼	2	770 332 107	16	50	31	48	67	53
-	G		1 ¼	2	770 332 207	16	50	31	48	67	53

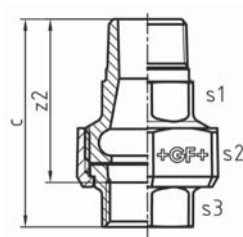
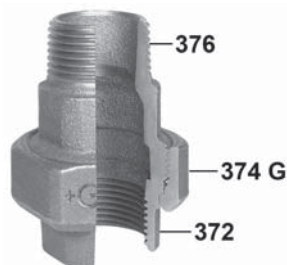

335 Union flat seat

- Supplied without sealing gaskets; c and z2 include the seal thickness as per table "Sealing Gasket Dimension".
- 374 G ... refers to the thread size G according to ISO 228 of the union nut 374.

EN	B/G	Dim. [inch]	374 G [inch]	Code	c [mm]	z2 [mm]	s1 [mm]	s2 [mm]	s3 [mm]
-	B	½	1	770 335 104	66	53	26	41	26
-	G	½	1	770 335 204	66	53	26	41	26
-	B	¾	1 ¼	770 335 105	72	57	32	48	31
-	G	¾	1 ¼	770 335 205	72	57	32	48	31
-	B	1	1 ½	770 335 106	82	65	38	55	38
-	G	1	1 ½	770 335 206	82	65	38	55	38
-	B	1 ¼	2	770 335 107	90	71	48	67	48
-	G	1 ¼	2	770 335 207	90	71	48	67	48
-	B	1 ½	2 ¼	770 335 108	95	76	54	74	54
-	G	1 ½	2 ¼	770 335 208	95	76	54	74	54

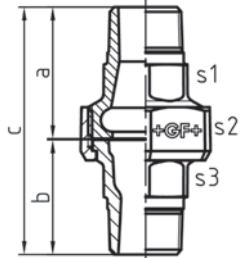
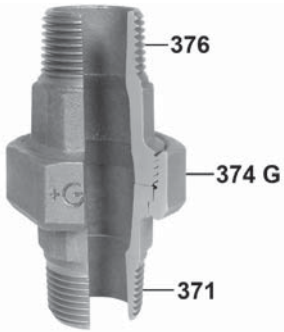

336 Union flat seat

- Supplied without sealing gaskets; c includes the seal thickness as per table "Sealing Gasket Dimension".
- 374 G ... refers to the thread size G according to ISO 228 of the union nut 374.

EN	B/G	Dim. [inch]	374 G [inch]	Code	a [mm]	b [mm]	c [mm]	s1 [mm]	s2 [mm]	s3 [mm]
-	B	1/2	1	770 336 104	43	40	85	26	41	23
-	G	1/2	1	770 336 204	43	40	85	26	41	23
-	B	3/4	1 1/4	770 336 105	48	42	92	32	48	30
-	G	3/4	1 1/4	770 336 205	48	42	92	32	48	30
-	B	1	1 1/2	770 336 106	54	47	103	38	55	36
-	G	1	1 1/2	770 336 206	54	47	103	38	55	36
-	B	1 1/4	2	770 336 107	57	55	114	48	67	48
-	G	1 1/4	2	770 336 207	57	55	114	48	67	48
-	B	1 1/2	2 1/4	770 336 108	61	57	120	54	74	54
-	G	1 1/2	2 1/4	770 336 208	61	57	120	54	74	54

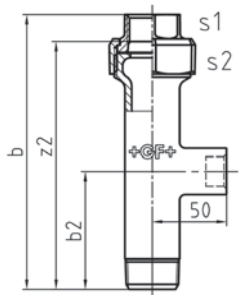
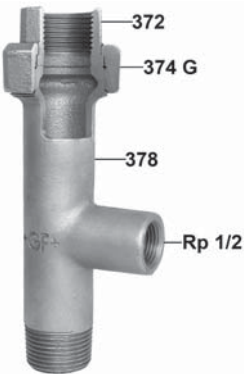

338 Distribution union flat seat

- Supplied without sealing gaskets; b and z2 include the seal thickness as per table "Sealing Gasket Dimension".
- 374 G ... refers to the thread size G according to ISO 228 of the union nut 374.

EN	B/G	Dim. [inch]	374 G [inch]	Code	b [mm]	b2 [mm]	z2 [mm]	s1 [mm]	s2 [mm]
-	G	3/4	1 1/4	770 338 220	177	74	160	31	48
-	G	1	1 1/2	770 338 221	174	67	155	38	55
-	G	1 1/4	2	770 338 222	174	59	153	48	67

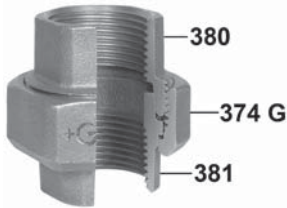

340 Union taper seat, ISO/EN U11

- Torque and notes for installation please find in "Technical Product Notes".
- 374 G ... refers to the thread size G according to ISO 228 of the union nut 374.
- * Inside hexagon
- ** Version

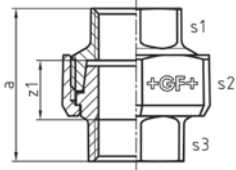

EN	B/G	Dim. [inch]	**	374 G [inch]	Code	a [mm]	z1 [mm]	s1 [mm]	s2 [mm]	s3 [mm]
•	B	1/8		1/2	770 340 101	38	24	15	26	15
•	G	1/8		1/2	770 340 201	38	24	15	26	15
•	B	1/4		5/8	770 340 102	42	22	19	28	*10
•	G	1/4		5/8	770 340 202	42	22	19	28	*10
•	B	3/8		3/4	770 340 103	48	28	22	32	*12
•	G	3/8		3/4	770 340 203	48	28	22	32	*12
•	B	1/2		1	770 340 104	48	22	26	41	25
•	G	1/2		1	770 340 204	48	22	26	41	25
•	B	1/2	s	1 1/8	770 340 120	48	22	26	44	26
•	G	1/2	s	1 1/8	770 340 220	48	22	26	44	26
•	B	3/4		1 1/4	770 340 105	52	22	31	48	32
•	G	3/4		1 1/4	770 340 205	52	22	31	48	32
•	B	1		1 1/2	770 340 106	58	24	38	55	38
•	G	1		1 1/2	770 340 206	58	24	38	55	38
•	B	1 1/4		2	770 340 107	65	27	48	67	48
•	G	1 1/4		2	770 340 207	65	27	48	67	48
•	B	1 1/2		2 1/4	770 340 108	70	32	54	74	54
•	G	1 1/2		2 1/4	770 340 208	70	32	54	74	54
•	B	2		2 3/4	770 340 109	78	30	66	90	66
•	G	2		2 3/4	770 340 209	78	30	66	90	66
•	B	2 1/2		3 1/2	770 340 110	90	36	85	111	85
•	G	2 1/2		3 1/2	770 340 210	90	36	85	111	85
•	B	3		4	770 340 111	101	41	96	130	96
•	G	3		4	770 340 211	101	41	96	130	96
•	B	4		5	770 340 112	114	42	120	151	120
•	G	4		5	770 340 212	114	42	120	151	120



341 Union taper seat, ISO/EN U12

- Torque and notes for installation please find in "Technical Product Notes".
- 374 G ... refers to the thread size G according to ISO 228 of the union nut 374.

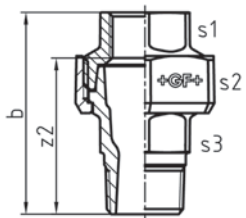

EN	B/G	Dim. [inch]	374 G [inch]	Code	b [mm]	z2 [mm]	s1 [mm]	s2 [mm]	s3 [mm]
•	B	1/4	5/8	770 341 102	55	45	19	28	15
•	G	1/4	5/8	770 341 202	55	45	19	28	15
•	B	3/8	3/4	770 341 103	59	49	22	32	20
•	G	3/8	3/4	770 341 203	59	49	22	32	20
•	B	1/2	1	770 341 104	66	53	26	41	23
•	G	1/2	1	770 341 204	66	53	26	41	23
•	B	3/4	1 1/4	770 341 105	72	57	31	48	30
•	G	3/4	1 1/4	770 341 205	72	57	31	48	30
•	B	1	1 1/2	770 341 106	80	63	38	55	36
•	G	1	1 1/2	770 341 206	80	63	38	55	36
•	B	1 1/4	2	770 341 107	90	71	48	67	48
•	G	1 1/4	2	770 341 207	90	71	48	67	48
•	B	1 1/2	2 1/4	770 341 108	96	77	54	74	54
•	G	1 1/2	2 1/4	770 341 208	96	77	54	74	54
•	B	2	2 3/4	770 341 109	106	82	66	90	66
•	G	2	2 3/4	770 341 209	106	82	66	90	66
•	B	2 1/2	3 1/2	770 341 110	122	95	85	111	85
•	G	2 1/2	3 1/2	770 341 210	122	95	85	111	85
•	B	3	4	770 341 111	134	104	96	130	95
•	G	3	4	770 341 211	134	104	96	130	95
-	B	4	5	770 341 112	153	117	120	151	120
-	G	4	5	770 341 212	153	117	120	151	120

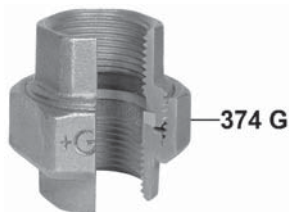

342 Union, spherical seat/taper seat Bronze to Iron, ISO/EN U11

- Torque and notes for installation please find in "Technical Product Notes".
- Not suitable for drinking water installation!
- 374 G ... refers to the thread size G according to ISO 228 of the union nut 374.

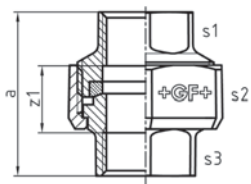

EN	B/G	Dim. [inch]	374 G [inch]	Code	a [mm]	z1 [mm]	s1 [mm]	s2 [mm]	s3 [mm]
•	B	½	1 ⅛	770 342 104	48	22	26	44	26
•	G	½	1 ⅛	770 342 204	48	22	26	44	26
•	B	¾	1 ¼	770 342 105	52	23	31	48	31
•	G	¾	1 ¼	770 342 205	52	23	31	48	31
•	B	1	1 ½	770 342 106	58	24	38	55	38
•	G	1	1 ½	770 342 206	58	24	38	55	38
•	B	1 ¼	2	770 342 107	65	27	48	67	48
•	G	1 ¼	2	770 342 207	65	27	48	67	48
•	B	1 ½	2 ¼	770 342 108	70	32	54	73	54
•	G	1 ½	2 ¼	770 342 208	70	32	54	73	54
•	B	2	2 ¾	770 342 109	78	32	66	90	66
•	G	2	2 ¾	770 342 209	78	32	66	90	66

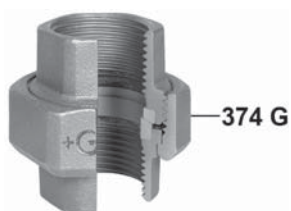

342a Union, spherical seat/taper seat Bronze to Bronze, ISO/ENU11

- Torque and notes for installation please find in "Technical Product Notes".
- Not suitable for drinking water installation!
- 374 G ... refers to the thread size G according to ISO 228 of the union nut 374.

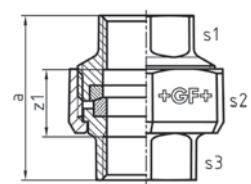

EN	B/G	Dim. [inch]	374 G [inch]	Code	a [mm]	z1 [mm]	s1 [mm]	s2 [mm]	s3 [mm]
•	B	½	1 ⅛	770 345 104	48	22	26	44	26
•	G	½	1 ⅛	770 345 204	48	22	26	44	26
•	B	¾	1 ¼	770 345 105	52	23	31	48	31
•	G	¾	1 ¼	770 345 205	52	23	31	48	31
•	B	1	1 ½	770 345 106	58	24	38	55	38
•	G	1	1 ½	770 345 206	58	24	38	55	38
•	B	1 ¼	2	770 345 107	65	27	48	67	48
•	G	1 ¼	2	770 345 207	65	27	48	67	48
•	B	1 ½	2 ¼	770 345 108	75	32	54	73	54
•	G	1 ½	2 ¼	770 345 208	75	32	54	73	54
•	B	2	2 ¾	770 345 109	85	32	66	90	66
•	G	2	2 ¾	770 345 209	85	32	66	90	66

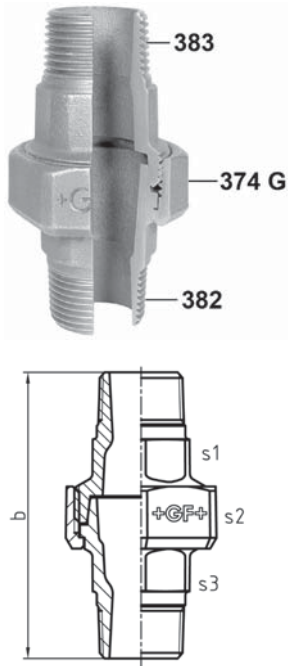

344 Union taper seat

- Torque and notes for installation please find in "Technical Product Notes".
- 374 G ... refers to the thread size G according to ISO 228 of the union nut 374.

EN	B/G	Dim. [inch]	374 G [inch]	Code	b [mm]	s1 [mm]	s2 [mm]	s3 [mm]
-	B	1/4	5/8	770 344 102	69	18	28	15
-	G	1/4	5/8	770 344 202	69	18	28	15
-	B	3/8	3/4	770 344 103	75	22	32	20
-	G	3/8	3/4	770 344 203	75	22	32	20
-	B	1/2	1	770 344 104	85	26	39	23
-	G	1/2	1	770 344 204	85	26	39	23
-	B	3/4	1 1/4	770 344 105	93	32	48	30
-	G	3/4	1 1/4	770 344 205	93	32	48	30
-	B	1	1 1/2	770 344 106	103	38	55	36
-	G	1	1 1/2	770 344 206	103	38	55	36
-	B	1 1/4	2	770 344 107	114	48	67	48
-	G	1 1/4	2	770 344 207	114	48	67	48
-	B	1 1/2	2 1/4	770 344 108	123	54	74	54
-	G	1 1/2	2 1/4	770 344 208	123	54	74	54
-	B	2	2 3/4	770 344 109	136	66	90	67
-	G	2	2 3/4	770 344 209	136	66	90	67

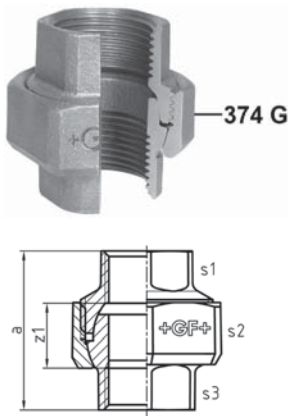

346 Union, spherical seat angular deviation max. 6°, ISO/EN U11

- Torque and notes for installation please find in "Technical Product Notes".
- 374 G ... refers to the thread size G according to ISO 228 of the union nut 374.

EN	B/G	Dim. [inch]	374 G [inch]	Code	a [mm]	z1 [mm]	s1 [mm]	s2 [mm]	s3 [mm]
•	B	1/2	1 1/8	770 346 104	48	22	26	44	26
•	G	1/2	1 1/8	770 346 204	48	22	26	44	26
•	B	3/4	1 1/4	770 346 105	52	23	31	48	31
•	G	3/4	1 1/4	770 346 205	52	23	31	48	31
•	B	1	1 1/2	770 346 106	58	24	38	55	38
•	G	1	1 1/2	770 346 206	58	24	38	55	38
•	B	1 1/4	2	770 346 107	65	27	48	67	48
•	G	1 1/4	2	770 346 207	65	27	48	67	48
•	B	1 1/2	2 1/4	770 346 108	75	32	54	73	54
•	G	1 1/2	2 1/4	770 346 208	75	32	54	73	54
•	B	2	2 3/4	770 346 109	85	32	66	90	66
•	G	2	2 3/4	770 346 209	85	32	66	90	66



350 Service union flat seat, with internal threads

- Information about application and installation please find in "Technical Product Notes".
- Supplied with sealing gaskets; a and z1 include the seal thickness of 2mm each.
- 374 G ... refers to the thread size G according to ISO 228 of the union nut 374.

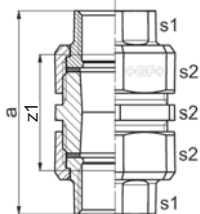

EN	B/G	Dim. [inch]	374 G [inch]	Code	a [mm]	z1 [mm]	s1 [mm]	s2 [mm]
-	B	½	1	770 350 104	81	55	26	41
-	G	½	1	770 350 204	81	55	26	41
-	B	¾	1 ¼	770 350 105	85	55	31	48
-	G	¾	1 ¼	770 350 205	85	55	31	48
-	B	1	1 ½	770 350 106	93	59	38	55
-	G	1	1 ½	770 350 206	93	59	38	55



351 Service union flat seat, with internal and external thread

- Information about application and installation please find in "Technical Product Notes".
- Supplied with sealing gaskets; b and z2 include the seal thickness of 2mm each.
- 374 G ... refers to the thread size G according to ISO 228 of the union nut 374.

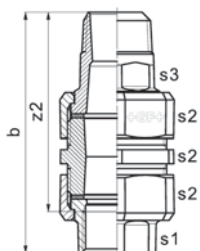

EN	B/G	Dim. [inch]	374 G [inch]	Code	b [mm]	z2 [mm]	s1 [mm]	s2 [mm]	s3 [mm]
-	B	½	1	770 351 104	99	86	26	41	23
-	G	½	1	770 351 204	99	86	26	41	23
-	B	¾	1 ¼	770 351 105	105	90	31	48	30
-	G	¾	1 ¼	770 351 205	105	90	31	48	30
-	B	1	1 ½	770 351 106	114	97	38	55	36
-	G	1	1 ½	770 351 206	114	97	38	55	36

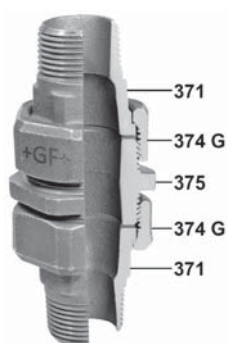

356 Service union flat seat, with external threads

- Information about application and installation please find in "Technical Product Notes".
- Supplied with sealing gaskets; c includes the seal thickness of 2mm each.
- 374 G ... refers to the thread size G according to ISO 228 of the union nut 374.

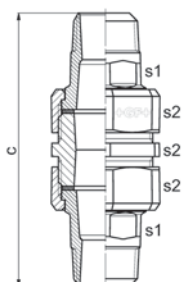

EN	B/G	Dim. [inch]	374 G [inch]	Code	c [mm]	s1 [mm]	s2 [mm]
-	B	½	1	770 356 104	117	23	41
-	G	½	1	770 356 204	117	23	41
-	B	¾	1 ¼	770 356 105	125	30	48
-	G	¾	1 ¼	770 356 205	125	30	48
-	B	1	1 ½	770 356 106	135	36	55
-	G	1	1 ½	770 356 206	135	36	55

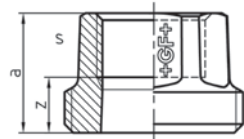
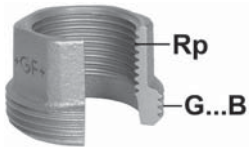

370 Union bush flat seat

- * Is usually not supplied as a separate piece.
- ** Version

EN	B/G	Dim. Rp [inch]	**	G...B [inch]	Code	a [mm]	z [mm]	s [mm]	Shape
* -	B	1/4		5/8		21	11	19	hexagon
* -	G	1/4		5/8		21	11	19	hexagon
* -	B	3/8		3/4		23	13	22	hexagon
* -	G	3/8		3/4		23	13	22	hexagon
-	B	1/2		1	770 370 119	25	12	26	hexagon
-	G	1/2		1	770 370 219	25	12	26	hexagon
-	B	1/2	s	1 1/8	770 370 120	25	12	26	hexagon
-	G	1/2	s	1 1/8	770 370 220	25	12	26	hexagon
-	B	3/4		1 1/4	770 370 105	28	13	32	hexagon
-	G	3/4		1 1/4	770 370 205	28	13	32	hexagon
-	B	1		1 1/2	770 370 106	31	14	38	hexagon
-	G	1		1 1/2	770 370 206	31	14	38	hexagon
-	B	1 1/4		2	770 370 107	33	14	48	hexagon
-	G	1 1/4		2	770 370 207	33	14	48	hexagon
-	B	1 1/2		2 1/4	770 370 108	36	17	54	hexagon
-	G	1 1/2		2 1/4	770 370 208	36	17	54	hexagon
-	B	2		2 3/4	770 370 109	42	18	66	hexagon
-	G	2		2 3/4	770 370 209	42	18	66	hexagon
-	B	2 1/2		3 1/2	770 370 110	41	14	85	octagon
-	G	2 1/2		3 1/2	770 370 210	41	14	85	octagon
-	B	3		4	770 370 111	48	18	96	octagon
-	G	3		4	770 370 211	48	18	96	octagon
* -	B	4		5		62	26	122	octagon
* -	G	4		5		62	26	122	octagon

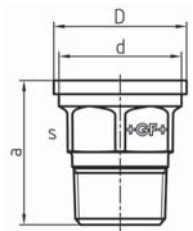
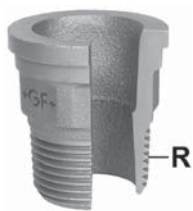

371 Union end flat seat, equal

- G ... refers to the thread size G of the union nut 374, which can be combined with the union end.
- * Is usually not supplied as a separate piece.

EN	B/G	Dim. R [inch]	G [inch]	Code	a [mm]	D [mm]	d [mm]	s [mm]	Shape
* -	B	1/4	5/8		32	20.3	18.1	15	hexagon
* -	G	1/4	5/8		32	20.3	18.1	15	hexagon
* -	B	3/8	3/4		34	23.8	21.6	19	octagon
* -	G	3/8	3/4		34	23.8	21.6	19	octagon
-	B	1/2	1	770 371 104	40	30.0	27.0	23	hexagon
-	G	1/2	1	770 371 204	40	30.0	27.0	23	hexagon
-	B	3/4	1 1/4	770 371 105	42	38.6	35.5	30	hexagon
-	G	3/4	1 1/4	770 371 205	42	38.6	35.5	30	hexagon
-	B	1	1 1/2	770 371 106	47	44.4	40.9	36	hexagon
-	G	1	1 1/2	770 371 206	47	44.4	40.9	36	hexagon
-	B	1 1/4	2	770 371 107	57	56.3	52.4	48	hexagon
-	G	1 1/4	2	770 371 207	57	56.3	52.4	48	hexagon
-	B	1 1/2	2 1/4	770 371 108	57	62.3	58.4	54	hexagon
-	G	1 1/2	2 1/4	770 371 208	57	62.3	58.4	54	hexagon
-	B	2	2 3/4	770 371 109	62	78.2	73.4	66	hexagon
-	G	2	2 3/4	770 371 209	62	78.2	73.4	66	hexagon
-	B	2 1/2	3 1/2	770 371 110	75	97.0	91.9	85	octagon
-	G	2 1/2	3 1/2	770 371 210	75	97.0	91.9	85	octagon
-	B	3	4	770 371 111	80	109.6	104.4	95	octagon
-	G	3	4	770 371 211	80	109.6	104.4	95	octagon



371 Union end flat seat, reducing

- Union end for 374 1 d=42.5
- G ... refers to the thread size G of the union nut 374, which can be combined with the union end.

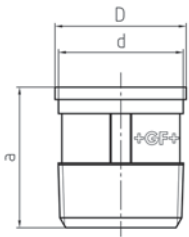

EN	B/G	Dim. R [inch]	G [inch]	Code	a [mm]	D [mm]	d [mm]	Shape
-	B	1 - 1 ¼	1 ½	770 371 115	47	44.4	42.2	round



372 Union end flat seat, equal

- G ... refers to the thread size G of the union nut 374, which can be combined with the union end.
- * Is usually not supplied as a separate piece.
- ** Version
- I hex = Internal hexagon

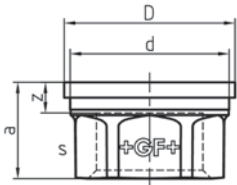

EN	B/G	Dim. Rp [inch]	**	G [inch]	Code	a [mm]	D [mm]	d [mm]	z [mm]	s [mm]	Shape
* -	B	¼		⅝		20.0	20.3	18.1	10.0	10	I hex
* -	G	¼		⅝		20.0	20.3	18.1	10.0	10	I hex
* -	B	⅜		¾		22.0	23.8	21.6	12.0	12	I hex
* -	G	⅜		¾		22.0	23.8	21.6	12.0	12	I hex
-	B	½		1	770 372 119	22.0	30.0	27.1	9.0	25	hexagon
-	G	½		1	770 372 219	22.0	30.0	27.1	9.0	25	hexagon
-	B	½	s	1 ⅛	770 372 104	22.0	34.6	31.5	9.0	26	hexagon
-	G	½	s	1 ⅛	770 372 204	22.0	34.6	31.5	9.0	26	hexagon
-	B	¾		1 ¼	770 372 105	22.0	38.6	35.5	7.0	31	hexagon
-	G	¾		1 ¼	770 372 205	22.0	38.6	35.5	7.0	31	hexagon
-	B	1		1 ½	770 372 106	26.0	44.4	40.9	9.0	38	hexagon
-	G	1		1 ½	770 372 206	26.0	44.4	40.9	9.0	38	hexagon
-	B	1 ¼		2	770 372 107	31.0	56.3	52.4	12.0	48	hexagon
-	G	1 ¼		2	770 372 207	31.0	56.3	52.4	12.0	48	hexagon
-	B	1 ½		2 ¼	770 372 108	32.5	62.3	58.4	13.5	54	hexagon
-	G	1 ½		2 ¼	770 372 208	32.5	62.3	58.4	13.5	54	hexagon
-	B	2		2 ¾	770 372 109	35.0	78.2	73.4	11.0	66	hexagon
-	G	2		2 ¾	770 372 209	35.0	78.2	73.4	11.0	66	hexagon
-	B	2 ½		3 ½	770 372 110	39.0	97.0	91.9	12.0	85	octagon
-	G	2 ½		3 ½	770 372 210	39.0	97.0	91.9	12.0	85	octagon
-	B	3		4	770 372 111	45.0	109.6	104.4	15.0	96	octagon
-	G	3		4	770 372 211	45.0	109.6	104.4	15.0	96	octagon
* -	B	4		5		46.0	135.0	128.7	12.0	122	octagon
* -	G	4		5		46.0	135.0	128.7	12.0	122	octagon

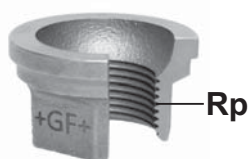

372 Union end flat seat, reducing

- G ... refers to the thread size G of the union nut 374, which can be combined with the union end.

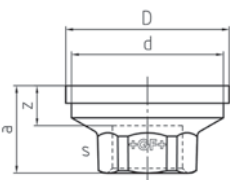

EN	B/G	Dim. Rp [inch]	G [inch]	Code	a [mm]	D [mm]	d [mm]	z [mm]	s [mm]	Shape
-	B	1 - ¾	1 ½	770 372 115	25	44.4	41.0	10	32	hexagon
-	G	1 - ¾	1 ½	770 372 215	25	44.4	41.0	10	32	hexagon
-	B	1 ¼ - ¾	2	770 372 133	30	56.3	52.5	15	32	hexagon
-	G	1 ¼ - ¾	2	770 372 233	30	56.3	52.5	15	32	hexagon
-	B	1 ¼ - 1	2	770 372 116	31	56.3	52.4	14	38	hexagon
-	G	1 ¼ - 1	2	770 372 216	31	56.3	52.4	14	38	hexagon

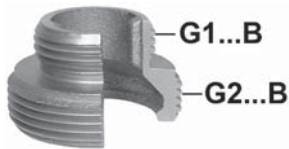

373 Union bush flat seat

- Sealing gaskets for sealing surface as per table "Sealing Gasket Dimension" (catalogue no. 332, symbol ◯).

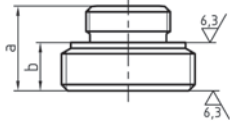

EN	B/G	G1...B [inch]	G2...B [inch]	Code	a [mm]	b [mm]
-	B	3/4	1 1/4	770 373 105	27	15
-	G	3/4	1 1/4	770 373 205	27	15
-	B	1	1 1/2	770 373 106	29	15
-	G	1	1 1/2	770 373 206	29	15
-	B	1 1/4	2	770 373 107	33	17
-	G	1 1/4	2	770 373 207	33	17



374 Union nut

- * Is usually not supplied as a separate piece.
- ** Version
- *** Union nut for 371 1 - 1 1/4

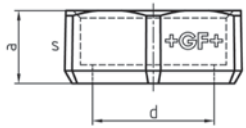

EN	B/G	Dim. [inch]	**	Dim. G [inch]	Code	a [mm]	d [mm]	s [mm]	Shape
* -	B	1/8		1/2		15	16.5	26	hexagon
* -	G	1/8		1/2		15	16.5	26	hexagon
* -	B	1/4	s	5/8		15	18.4	28	hexagon
* -	G	1/4	s	5/8		15	18.4	28	hexagon
* -	B	1/4		3/4		16	21.9	32	hexagon
* -	G	1/4		3/4		16	21.9	32	hexagon
-	B	3/8		3/4	770 374 116	16	21.9	32	hexagon
-	G	3/8		3/4	770 374 216	16	21.9	32	hexagon
-	B	3/8	s	7/8	770 374 118	17	24.9	36	hexagon
-	G	3/8	s	7/8	770 374 218	17	24.9	36	hexagon
-	B	1/2		1	770 374 119	18	27.3	41	hexagon
-	G	1/2		1	770 374 219	18	27.3	41	hexagon
-	B	1/2	s	1 1/8	770 374 120	19	31.8	44	hexagon
-	G	1/2	s	1 1/8	770 374 220	19	31.8	44	hexagon
-	B	3/4		1 1/4	770 374 105	20	35.8	48	hexagon
-	G	3/4		1 1/4	770 374 205	20	35.8	48	hexagon
-	B	3/4	34,4	1 1/4	770 374 135	20	34.4	48	hexagon
-	B	1	s	1 1/2	770 374 106	22	41.3	55	hexagon
-	G	1	s	1 1/2	770 374 206	22	41.3	55	hexagon
-	B	1		1 1/2	770 960 180	22	41.3	55	octagon
*** -	B	1	42,5	1 1/2	770 374 121	22	42.5	55	hexagon
-	B	1 1/4		2	770 374 107	24	52.8	67	hexagon
-	G	1 1/4		2	770 374 207	24	52.8	67	hexagon
-	B	1 1/2		2 1/4	770 374 108	25	58.8	74	hexagon
-	G	1 1/2		2 1/4	770 374 208	25	58.8	74	hexagon
-	B	2		2 3/4	770 374 109	27	73.8	90	hexagon
-	G	2		2 3/4	770 374 209	27	73.8	90	hexagon
-	B	2 1/2		3 1/2	770 374 110	30	92.3	111	octagon
-	G	2 1/2		3 1/2	770 374 210	30	92.3	111	octagon
-	B	3		4	770 374 111	31	104.8	131	octagon
-	G	3		4	770 374 211	31	104.8	131	octagon
* -	B	4		5		35	129.2	151	octagon
* -	G	4		5		35	129.2	151	octagon

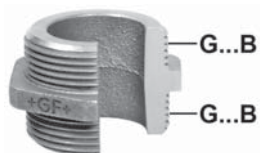

375 Union bush flat seat

- Union bush for 350, 351 and 356

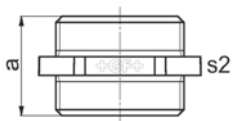

EN	B/G	Dim. [inch]	G...B [inch]	Code	a [mm]	s2 [mm]
-	B	1/2	1	770 375 104	33	41
-	G	1/2	1	770 375 204	33	41
-	B	3/4	1 1/4	770 375 105	37	48
-	G	3/4	1 1/4	770 375 205	37	48
-	B	1	1 1/2	770 375 106	37	55
-	G	1	1 1/2	770 375 206	37	55

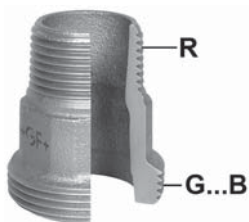

376 Union bush flat seat

- ** Version

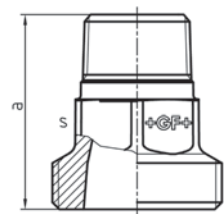

EN	B/G	Dim. R [inch]	**	G...B [inch]	Code	a [mm]	s [mm]	Shape
-	B	1/2		1	770 376 105	43.0	26	hexagon
-	G	1/2		1	770 376 205	43.0	26	hexagon
-	B	1/2	s	1 1/8	770 376 125	41.5	26	hexagon
-	G	1/2	s	1 1/8	770 376 225	41.5	26	hexagon
-	B	3/4		1 1/4	770 376 106	48.0	32	hexagon
-	G	3/4		1 1/4	770 376 206	48.0	32	hexagon
-	B	1		1 1/2	770 376 107	54.0	38	hexagon
-	G	1		1 1/2	770 376 207	54.0	38	hexagon
-	B	1 1/4		2	770 376 108	57.0	48	hexagon
-	G	1 1/4		2	770 376 208	57.0	48	hexagon
-	B	1 1/2		2 1/4	770 376 109	61.0	54	hexagon
-	G	1 1/2		2 1/4	770 376 209	61.0	54	hexagon
-	B	2		2 3/4	770 376 110	71.0	66	hexagon
-	G	2		2 3/4	770 376 210	71.0	66	hexagon



378 Distribution union bush, flat seat

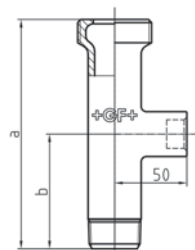

EN	B/G	Dim. R [inch]	G...B [inch]	Code	a [mm]	b [mm]
-	G	3/4	1 1/4	770 378 220	153	74
-	G	1	1 1/2	770 378 221	146	67
-	G	1 1/4	2	770 378 222	141	59

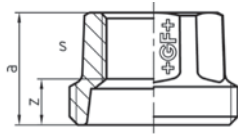
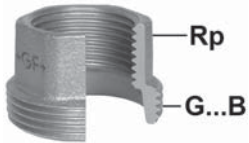

380 Union bush taper seat

- Is usually not supplied as a separate piece.
- ** Version

EN	B/G	Dim. Rp [inch]	**	G...B [inch]	Code	a [mm]	z [mm]	s [mm]	Shape
-	B	1/8		1/2		19	12	15	hexagon
-	G	1/8		1/2		19	12	15	hexagon
-	B	1/4		5/8		21	11	19	hexagon
-	G	1/4		5/8		21	11	19	hexagon
-	B	3/8		3/4		23	13	22	hexagon
-	G	3/8		3/4		23	13	22	hexagon
-	B	1/2		1		25	11	26	hexagon
-	G	1/2		1		25	11	26	hexagon
-	B	1/2	s	1 1/8		25	11	26	hexagon
-	G	1/2	s	1 1/8		25	11	26	hexagon
-	B	3/4		1 1/4		28	13	32	hexagon
-	G	3/4		1 1/4		28	13	32	hexagon
-	B	1		1 1/2		31	14	38	hexagon
-	G	1		1 1/2		31	14	38	hexagon
-	B	1 1/4		2		33	14	48	hexagon
-	G	1 1/4		2		33	14	48	hexagon
-	B	1 1/2		2 1/4		36	17	54	hexagon
-	G	1 1/2		2 1/4		36	17	54	hexagon
-	B	2		2 3/4		42	18	66	hexagon
-	G	2		2 3/4		42	18	66	hexagon
-	B	2 1/2		3 1/2		41	14	85	octagon
-	G	2 1/2		3 1/2		41	14	85	octagon
-	B	3		4		48	18	96	octagon
-	G	3		4		48	18	96	octagon
-	B	4		5		62	26	120	octagon
-	G	4		5		62	26	120	octagon

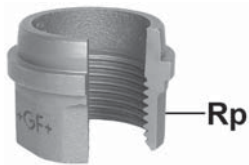

381 Union end taper seat

- Is usually not supplied as a separate piece.
- G ... refers to the thread size G of the union nut 374, which can be combined with the union end.
- ** Version
- I hex = Internal hexagon

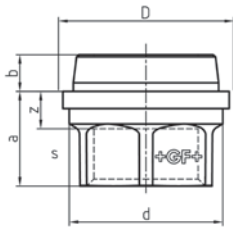

EN	B/G	Dim. Rp [inch]	**	G [inch]	Code	a [mm]	b [mm]	D [mm]	d [mm]	z [mm]	s [mm]	Shape
-	B	1/8		1/2		17.5	6.5	18.4	15.8	10.5	15	hexagon
-	G	1/8		1/2		17.5	6.5	18.4	15.8	10.5	15	hexagon
-	B	1/4		5/8		20.5	6.0	20.3	18.1	10.5	10	I hex
-	G	1/4		5/8		20.5	6.0	20.3	18.1	10.5	10	I hex
-	B	3/8		3/4		22.0	6.5	23.8	21.6	12.0	12	I hex
-	G	3/8		3/4		22.0	6.5	23.8	21.6	12.0	12	I hex
-	B	1/2		1		22.5	7.5	30.0	27.0	9.5	25	octagon
-	G	1/2		1		22.5	7.5	30.0	27.0	9.5	25	octagon
-	B	1/2	s	1 1/8		21.0	8.0	34.6	31.5	8.0	26	hexagon
-	G	1/2	s	1 1/8		21.0	8.0	34.6	31.5	8.0	26	hexagon
-	B	3/4		1 1/4		22.5	8.0	38.6	35.5	6.5	30	hexagon
-	G	3/4		1 1/4		22.5	8.0	38.6	35.5	6.5	30	hexagon
-	B	1		1 1/2		26.5	8.5	44.4	40.9	8.5	38	hexagon
-	G	1		1 1/2		26.5	8.5	44.4	40.9	8.5	38	hexagon
-	B	1 1/4		2		31.5	9.0	56.3	52.4	12.0	48	hexagon
-	G	1 1/4		2		31.5	9.0	56.3	52.4	12.0	48	hexagon
-	B	1 1/2		2 1/4		33.0	9.5	62.3	58.4	14.0	54	hexagon
-	G	1 1/2		2 1/4		33.0	9.5	62.3	58.4	14.0	54	hexagon
-	B	2		2 3/4		35.5	11.5	78.2	73.4	10.5	66	hexagon
-	G	2		2 3/4		35.5	11.5	78.2	73.4	10.5	66	hexagon
-	B	2 1/2		3 1/2		42.5	13.5	97.0	91.9	15.5	85	octagon
-	G	2 1/2		3 1/2		42.5	13.5	97.0	91.9	15.5	85	octagon
-	B	3		4		45.5	14.5	109.6	104.4	15.5	96	octagon
-	G	3		4		45.5	14.5	109.6	104.4	15.5	96	octagon
-	B	4		5		46.5	15.5	135.0	128.7	10.5	120	octagon
-	G	4		5		46.5	15.5	135.0	128.7	10.5	120	octagon

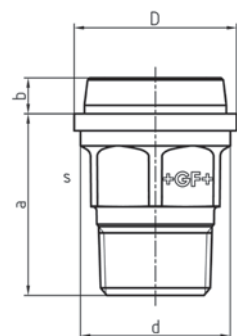

382 Union end taper seat

- Is usually not supplied as a separate piece.
- G ... refers to the thread size G of the union nut 374, which can be combined with the union end.

EN	B/G	Dim. R [inch]	G [inch]	Code	a [mm]	b [mm]	D [mm]	d [mm]	s [mm]	Shape
-	B	1/4	5/8		32.0	6.0	20.3	18.1	15	hexagon
-	G	1/4	5/8		32.0	6.0	20.3	18.1	15	hexagon
-	B	3/8	3/4		34.0	6.5	23.8	21.6	19	octagon
-	G	3/8	3/4		34.0	6.5	23.8	21.6	19	octagon
-	B	1/2	1		40.5	7.5	30.0	27.0	23	hexagon
-	G	1/2	1		40.5	7.5	30.0	27.0	23	hexagon
-	B	3/4	1 1/4		43.8	8.0	38.6	35.5	30	hexagon
-	G	3/4	1 1/4		43.8	8.0	38.6	35.5	30	hexagon
-	B	1	1 1/2		49.5	8.5	44.4	40.9	36	hexagon
-	G	1	1 1/2		49.5	8.5	44.4	40.9	36	hexagon
-	B	1 1/4	2		56.0	9.0	56.3	52.4	48	hexagon
-	G	1 1/4	2		56.0	9.0	56.3	52.4	48	hexagon
-	B	1 1/2	2 1/4		58.0	9.5	62.3	58.4	54	hexagon
-	G	1 1/2	2 1/4		58.0	9.5	62.3	58.4	54	hexagon
-	B	2	2 3/4		62.5	11.5	78.2	73.4	66	hexagon
-	G	2	2 3/4		62.5	11.5	78.2	73.4	66	hexagon
-	B	2 1/2	3 1/2		75.5	13.5	97.0	91.9	85	octagon
-	G	2 1/2	3 1/2		75.5	13.5	97.0	91.9	85	octagon
-	B	3	4		80.5	14.5	109.6	104.4	95	octagon
-	G	3	4		80.5	14.5	109.6	104.4	95	octagon
-	B	4	5		87.0	15.5	135.0	128.7	120	hexagon
-	G	4	5		87.0	15.5	135.0	128.7	120	hexagon

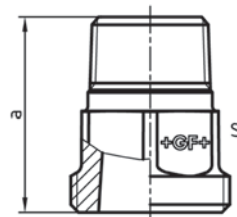
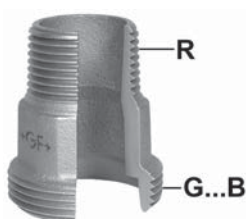

383 Union bush taper seat

- Is usually not supplied as a separate piece.

EN	B/G	Dim. R [inch]	G...B [inch]	Code	a [mm]	s [mm]	Shape
-	B	1/4	5/8		35	19	hexagon
-	G	1/4	5/8		35	19	hexagon
-	B	3/8	3/4		39	22	hexagon
-	G	3/8	3/4		39	22	hexagon
-	B	1/2	1		43	26	hexagon
-	G	1/2	1		43	26	hexagon
-	B	3/4	1 1/4		48	32	hexagon
-	G	3/4	1 1/4		48	32	hexagon
-	B	1	1 1/2		54	38	hexagon
-	G	1	1 1/2		54	38	hexagon
-	B	1 1/4	2		58	48	hexagon
-	G	1 1/4	2		58	48	hexagon
-	B	1 1/2	2 1/4		61	54	hexagon
-	G	1 1/2	2 1/4		61	54	hexagon
-	B	2	2 3/4		71	66	hexagon
-	G	2	2 3/4		71	66	hexagon



471 Bracket elbow

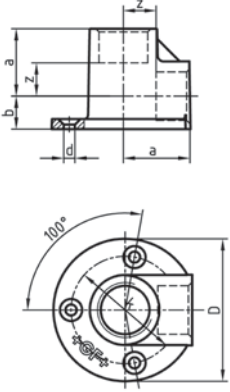

EN	B/G	Dim. [inch]	Code	a [mm]	b [mm]	d [mm]	z [mm]	k [mm]	D [mm]
-	G	3/8	770 471 203	25	12	4.5	15	41.5	60
-	G	1/2	770 471 204	28	14	5.5	15	44.5	62
-	G	3/4	770 471 205	33	17	5.5	18	53.5	70



526 Extension tube

- * Due to overall fitting length, the length of the external thread does not comply with the standard.

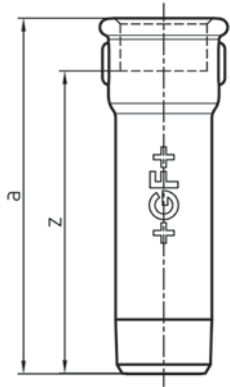

EN	B/G	Dim. [inch]	Length [mm]	Code	a [mm]	z [mm]
-	B	3/8	100	770 526 119	100	90
-	G	3/8	100	770 526 219	100	90
* -	B	1/2	30	770 526 120	30	17
* -	G	1/2	30	770 526 220	30	17
-	B	1/2	50	770 526 121	50	37
-	G	1/2	50	770 526 221	50	37
-	B	1/2	60	770 526 122	60	47
-	G	1/2	60	770 526 222	60	47
-	B	1/2	70	770 526 123	70	57
-	G	1/2	70	770 526 223	70	57
-	B	1/2	80	770 526 124	80	67
-	G	1/2	80	770 526 224	80	67
-	B	1/2	100	770 526 125	100	87
-	G	1/2	100	770 526 225	100	87
-	B	1/2	120	770 526 126	120	107
-	G	1/2	120	770 526 226	120	107
* -	B	3/4	30	770 526 127	30	15
* -	G	3/4	30	770 526 227	30	15
* -	B	3/4	40	770 526 128	40	25
* -	G	3/4	40	770 526 228	40	25
-	B	3/4	60	770 526 129	60	45
-	G	3/4	60	770 526 229	60	45
-	B	3/4	70	770 526 130	70	55
-	G	3/4	70	770 526 230	70	55
-	B	3/4	80	770 526 131	80	65
-	G	3/4	80	770 526 231	80	65
-	B	3/4	100	770 526 132	100	85
-	G	3/4	100	770 526 232	100	85
* -	B	1	40	770 526 133	40	23
* -	G	1	40	770 526 233	40	23
-	B	1	80	770 526 134	80	63
-	G	1	80	770 526 234	80	63
-	B	1	100	770 526 135	100	83
-	G	1	100	770 526 235	100	83

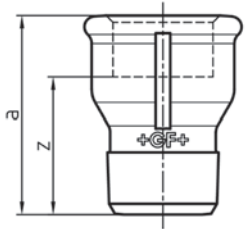

529a

Socket, internal and external thread, ISO/EN M4

- ST ... these types of fittings are made from steel (galvanised finish = electroplated) and not suitable for drinking water installations. Steel parts are hexagonal instead of beaded.

EN	B/G	Dim. [inch]	Code	a [mm]	s [mm]	z [mm]
ST -	B	¼	770 529 102	28	17	18
ST -	G	¼	770 529 202	28	17	18
ST •	B	⅜	770 529 103	35	22	25
ST •	G	⅜	770 529 203	35	22	25
•	B	½	770 529 104	43		30
•	G	½	770 529 204	43		30
•	B	¾	770 529 105	48		33
•	G	¾	770 529 205	48		33
•	B	1	770 529 106	55		38
•	G	1	770 529 206	55		38
-	B	1 ¼	770 529 107	60		41
-	G	1 ¼	770 529 207	60		41
-	B	1 ½	770 529 108	63		44
-	G	1 ½	770 529 208	63		44
-	B	2	770 529 109	70		46
-	G	2	770 529 209	70		46

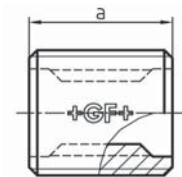
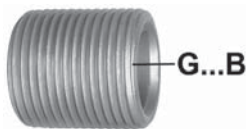

531

Nipple

- ST ... these types of fittings are made from steel (galvanised finish = electroplated) and not suitable for drinking water installations.

EN	B/G	G...B [inch]	Code	a [mm]
ST -	B	⅜	770 970 145	23
ST -	G	⅜	770 970 245	23
ST -	B	½	770 970 146	25
ST -	G	½	770 970 246	25
ST -	B	¾	770 970 147	30
ST -	G	¾	770 970 247	30
ST -	B	1	770 970 148	35
ST -	G	1	770 970 248	35

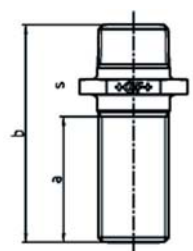
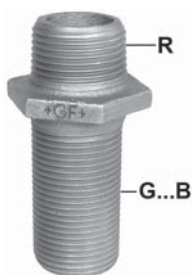

534

Longscrew hexagon nipple

- Hot dip galvanised, thread electroplated.

EN	B/G	Dim. [inch]	Code	a [mm]	b [mm]	s [mm]
-	G	½	770 534 204	46	77	32
-	G	¾	770 534 205	49	82	36
-	G	1	770 534 206	56	92	46

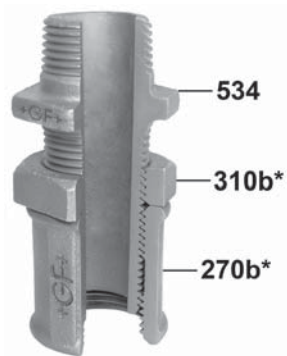

535 Longscrew hexagon nipple, complete

- * Large chamfer (gasket chamber)

EN	B/G	Dim. [inch]	Code	a [mm]	b [mm]	s [mm]
-	G	1/2	770 535 204	46	77	32
-	G	3/4	770 535 205	49	82	36
-	G	1	770 535 206	56	92	46

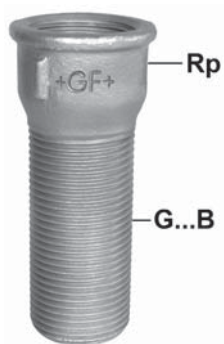
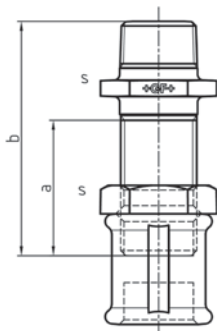

536 Longscrew socket

- Hot dip galvanised, thread electroplated.

EN	B/G	Dim. [inch]	Length [mm]	Code	a [mm]	b [mm]
-	G	1/2	80	770 536 204	50	80
-	G	3/4	90	770 536 205	57	90
-	G	1	100	770 536 206	65	100
-	G	1 1/4	116	770 536 207	75	116
-	G	1 1/2	125	770 536 208	84	125
-	G	2	143	770 536 209	98	143

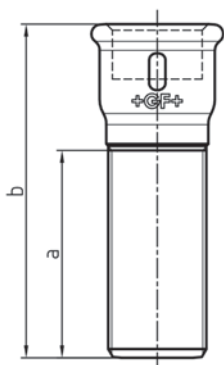

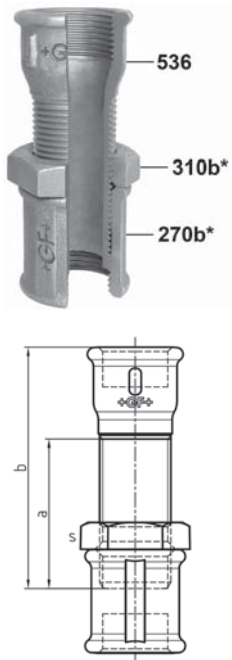

537 Longscrew socket, complete

- * Large chamfer (gasket chamber)

EN	B/G	Dim. [inch]	Code	a [mm]	b [mm]	s [mm]
-	G	1/2	770 537 204	50	80	32
-	G	3/4	770 537 205	57	90	36
-	G	1	770 537 206	65	100	46
-	G	1 1/4	770 537 207	75	116	55
-	G	1 1/2	770 537 208	84	125	60
-	G	2	770 537 209	98	143	73

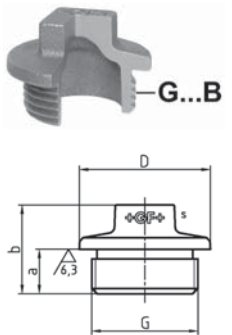

595 Plug with one machined face

EN	B/G	G...B [inch]	Code	a [mm]	b [mm]	D [mm]	s [mm]
-	B	1/2	770 595 104	11	23	28	11
-	G	1/2	770 595 204	11	23	28	11
-	B	3/4	770 595 105	11	24	35	17
-	G	3/4	770 595 205	11	24	35	17
-	B	1	770 595 106	14	28	41	19
-	G	1	770 595 206	14	28	41	19

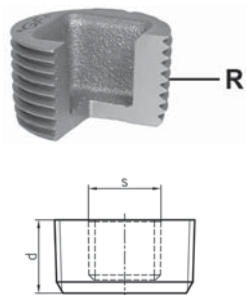

596 Plug, hexagon/square inside, ISO/EN T11

- ST ... these types of fittings are made from steel (galvanised finish = electroplated) and not suitable for drinking water installations.

EN	B/G	Dim. R [inch]	Code	d [mm]	s [mm]	Shape
ST -	B	1/8	770 596 101	8	5	hexagonal
ST -	G	1/8	770 596 201	8	5	hexagonal
ST -	B	1/4	770 596 102	10	7	hexagonal
ST -	G	1/4	770 596 202	10	7	hexagonal
ST •	B	3/8	770 596 103	10	8	hexagonal
ST •	G	3/8	770 596 203	10	8	hexagonal
•	B	1/2	770 596 104	15	10	square
•	G	1/2	770 596 204	15	10	square
•	B	3/4	770 596 105	17	12	square
•	G	3/4	770 596 205	17	12	square
•	B	1	770 596 106	19	16	square
•	G	1	770 596 206	19	16	square
-	B	1 1/4	770 596 107	22	22	square
-	G	1 1/4	770 596 207	22	22	square
-	B	1 1/2	770 596 108	22	22	square
-	G	1 1/2	770 596 208	22	22	square
-	B	2	770 596 109	27	27	square
-	G	2	770 596 209	27	27	square

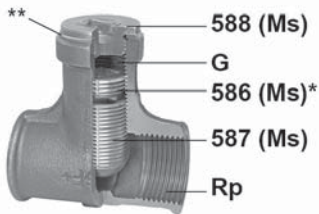

599a Regulation socket

- * with backnut for anti-twist device
- ** Gasket

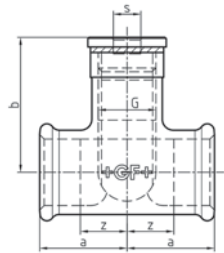

EN	B/G	Dim. Rp [inch]	G...B [inch]	Code	a [mm]	b [mm]	z [mm]	s [mm]
-	B	1/2	3/8	770 599 104	27	46	14	8
-	G	1/2	3/8	770 599 204	27	46	14	8
-	B	3/4	1/2	770 599 105	32	56	17	10
-	G	3/4	1/2	770 599 205	32	56	17	10
-	B	1	3/4	770 599 106	38	65	21	12
-	G	1	3/4	770 599 206	38	65	21	12
-	B	1 1/4	1 1/8	770 599 107	45	81	26	17
-	G	1 1/4	1 1/8	770 599 207	45	81	26	17
-	B	1 1/2	1 1/4	770 599 108	47	77	28	22
-	B	2	1 3/4	770 599 109	57	99	33	27

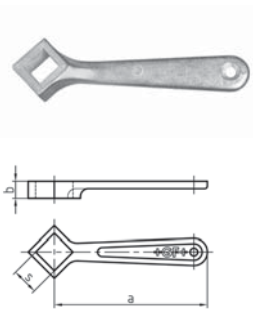

901 Stopcock spanner

Dim. s [mm]	Code	a [mm]	b [mm]
10	770 901 215	88	11
12	770 901 217	95	12
14	770 901 218	110	13
17	770 901 219	130	14

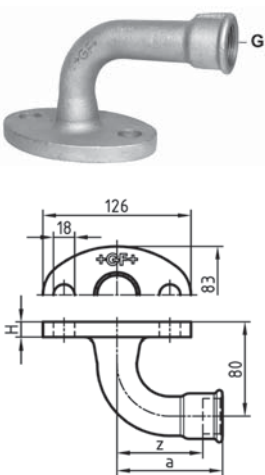

933 Water meter bend

EN	B/G	G...B [inch]	Code	a [mm]	z [mm]	H [mm]
-	G	3/4	770 933 205	115	100	14
-	G	1	770 933 206	90	73	13
-	G	1 1/4	770 933 207	90	71	13

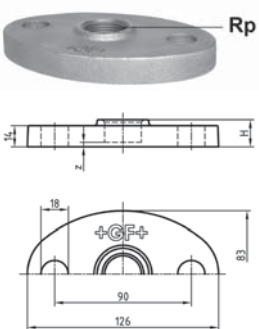

933a Counter Flange to fig. 933

EN	B/G	Code	Dim. Rp [inch]	H [mm]	z [mm]
-	G	770 932 205	3/4	18	3
-	G	770 932 206	1	19	2
-	G	770 932 207	1 1/4	22	3

FM certified assortment

Equal fittings, sizes $\frac{1}{2}$ - $\frac{3}{4}$ - 1 - $1\frac{1}{4}$ - $1\frac{1}{2}$ - 2

1	Long sweep bend	90	Elbow	280	Hexagon nipple
2		92		290	Plug, beaded
3		94		291	Plug, plain, hollow
40	Long sweep bend 45°	120	Elbow 45°	291a	(a ... solid)
41		121		300	Cap
1a	Short bend	130	Tee	340	Union taper seat
2a		134		341	
50	Bend 30°	*133	Tee (* $\frac{1}{2}$ - $\frac{3}{4}$ - 1)		
51		*135			
53	Bend 15°	180	Cross		
54		270	Socket		

Reduced fittings

90 reducing	
	
$\frac{1}{2}$ - $\frac{1}{4}$	
$\frac{1}{2}$ - $\frac{3}{8}$	
$\frac{3}{4}$ - $\frac{3}{8}$	
$\frac{3}{4}$ - $\frac{1}{2}$	
1 - $\frac{1}{2}$	
1 - $\frac{3}{4}$	
1 $\frac{1}{4}$ - $\frac{1}{2}$	
1 $\frac{1}{4}$ - $\frac{3}{4}$	
1 $\frac{1}{4}$ - 1	
1 $\frac{1}{2}$ - $\frac{3}{4}$	
1 $\frac{1}{2}$ - 1	
1 $\frac{1}{2}$ - $1\frac{1}{4}$	
2 - 1	
2 - $1\frac{1}{4}$	
2 - $1\frac{1}{2}$	

130 reducing	
	
$\frac{1}{2}$ - $\frac{1}{4}$	1 $\frac{1}{4}$ - 1 $\frac{1}{4}$ - $\frac{1}{2}$
$\frac{1}{2}$ - $\frac{3}{8}$	1 $\frac{1}{4}$ - 1 $\frac{1}{4}$ - $\frac{3}{4}$
$\frac{1}{2}$ - $\frac{3}{4}$	1 $\frac{1}{4}$ - 1 $\frac{1}{4}$ - 1
$\frac{1}{2}$ - 1	1 $\frac{1}{4}$ - 1 $\frac{1}{2}$
$\frac{3}{4}$ - $\frac{1}{4}$	1 $\frac{1}{4}$ - 1 $\frac{1}{2}$ - 1
$\frac{3}{4}$ - $\frac{3}{8}$	1 $\frac{1}{4}$ - 2
$\frac{3}{4}$ - $\frac{1}{2}$	1 $\frac{1}{2}$ - $\frac{1}{2}$
$\frac{3}{4}$ - $\frac{1}{2}$ - $\frac{1}{2}$	1 $\frac{1}{2}$ - $\frac{1}{2}$ - 1 $\frac{1}{4}$
$\frac{3}{4}$ - $\frac{3}{4}$ - $\frac{3}{8}$	1 $\frac{1}{2}$ - $\frac{3}{4}$
$\frac{3}{4}$ - $\frac{3}{4}$ - $\frac{1}{2}$	1 $\frac{1}{2}$ - $\frac{3}{4}$ - 1 $\frac{1}{4}$
$\frac{3}{4}$ - 1	1 $\frac{1}{2}$ - 1
$\frac{3}{4}$ - 1 - $\frac{1}{2}$	1 $\frac{1}{2}$ - 1 - 1
1 - $\frac{1}{4}$	1 $\frac{1}{2}$ - 1 $\frac{1}{4}$
1 - $\frac{3}{8}$	1 $\frac{1}{2}$ - 1 $\frac{1}{4}$ - 1 $\frac{1}{4}$
1 - $\frac{1}{2}$	1 $\frac{1}{2}$ - 1 $\frac{1}{2}$ - $\frac{1}{2}$
1 - $\frac{1}{2}$ - $\frac{1}{2}$	1 $\frac{1}{2}$ - 1 $\frac{1}{2}$ - $\frac{3}{4}$
1 - $\frac{1}{2}$ - $\frac{3}{4}$	1 $\frac{1}{2}$ - 1 $\frac{1}{2}$ - 1
1 - $\frac{3}{4}$	1 $\frac{1}{2}$ - 1 $\frac{1}{2}$ - 1 $\frac{1}{4}$
1 - $\frac{3}{4}$ - $\frac{1}{2}$	1 $\frac{1}{2}$ - 2
1 - $\frac{3}{4}$ - $\frac{3}{4}$	1 $\frac{1}{2}$ - 2 - 1 $\frac{1}{4}$
1 - 1 - $\frac{3}{8}$	2 - $\frac{1}{2}$
1 - 1 - $\frac{1}{2}$	2 - $\frac{1}{2}$ - 1 $\frac{1}{2}$
1 - 1 - $\frac{3}{4}$	2 - $\frac{3}{4}$
1 - 1 $\frac{1}{4}$	2 - $\frac{3}{4}$ - 1 $\frac{1}{2}$
1 - 1 $\frac{1}{4}$ - $\frac{3}{4}$	2 - 1
1 - 1 $\frac{1}{2}$	2 - 1 - 1 $\frac{1}{2}$
1 $\frac{1}{4}$ - $\frac{3}{8}$	2 - 1 $\frac{1}{4}$
1 $\frac{1}{4}$ - $\frac{1}{2}$	2 - 1 $\frac{1}{4}$ - 1 $\frac{1}{2}$
1 $\frac{1}{4}$ - $\frac{1}{2}$ - 1	2 - 1 $\frac{1}{2}$
1 $\frac{1}{4}$ - $\frac{3}{4}$	2 - 1 $\frac{1}{2}$ - 1 $\frac{1}{2}$
1 $\frac{1}{4}$ - $\frac{3}{4}$ - $\frac{3}{4}$	2 - 2 - $\frac{1}{2}$
1 $\frac{1}{4}$ - $\frac{3}{4}$ - 1	2 - 2 - $\frac{3}{4}$
1 $\frac{1}{4}$ - 1	2 - 2 - 1
1 $\frac{1}{4}$ - 1 - $\frac{3}{4}$	2 - 2 - 1 $\frac{1}{4}$
1 $\frac{1}{4}$ - 1 - 1	2 - 2 - 1 $\frac{1}{2}$

180 reducing	
	
$\frac{3}{4}$ - $\frac{1}{2}$	
1 - $\frac{1}{2}$	
1 - $\frac{3}{4}$	
1 $\frac{1}{4}$ - 1	
1 $\frac{1}{2}$ - 1	
2 - 1	

240, 241	
	
$\frac{1}{2}$ - $\frac{3}{8}$	
$\frac{3}{4}$ - $\frac{3}{8}$	
$\frac{3}{4}$ - $\frac{1}{2}$	
1 - $\frac{1}{2}$	
1 - $\frac{3}{4}$	
1 $\frac{1}{4}$ - $\frac{1}{2}$	
1 $\frac{1}{4}$ - $\frac{3}{4}$	
1 $\frac{1}{4}$ - 1	
1 $\frac{1}{2}$ - $\frac{1}{2}$	
1 $\frac{1}{2}$ - $\frac{3}{4}$	
1 $\frac{1}{2}$ - 1	
1 $\frac{1}{2}$ - 1 $\frac{1}{4}$	
2 - $\frac{1}{2}$	
2 - $\frac{3}{4}$	
2 - 1	
2 - 1 $\frac{1}{4}$	
2 - 1 $\frac{1}{2}$	

246	
	
$\frac{1}{2}$ - $\frac{3}{8}$	
$\frac{3}{4}$ - $\frac{3}{8}$	
$\frac{3}{4}$ - $\frac{1}{2}$	
1 - $\frac{1}{2}$	
1 - $\frac{3}{4}$	
1 $\frac{1}{4}$ - $\frac{1}{2}$	
1 $\frac{1}{4}$ - $\frac{3}{4}$	
1 $\frac{1}{4}$ - 1	
1 $\frac{1}{2}$ - $\frac{3}{4}$	
1 $\frac{1}{2}$ - 1	
1 $\frac{1}{2}$ - 1 $\frac{1}{4}$	
2 - 1	
2 - 1 $\frac{1}{4}$	
2 - 1 $\frac{1}{2}$	

92 reducing	
	
$\frac{1}{2}$ - $\frac{3}{4}$	
$\frac{3}{4}$ - $\frac{1}{2}$	
1 - $\frac{3}{4}$	
1 - $\frac{3}{4}$	
1 - 1 $\frac{1}{4}$	
1 $\frac{1}{4}$ - $\frac{3}{4}$	
1 $\frac{1}{4}$ - 1	
1 $\frac{1}{2}$ - 1	
1 $\frac{1}{2}$ - 1 $\frac{1}{4}$	

Available in black and galvanised finish, code-numbers (as standard article) see Product Range.

Technical Product Notes

Fittings sizes

Fitting sizes are designated based on the thread sizes defined in EN 10226-1 and ISO 7-1. Connection sizes of pipes, flanges or plumbing fixtures are designated according to thread sizes or nominal diameters (DN).

The following table shows the relationship between size of fittings and the nominal diameter (DN):

Thread size / fitting size	1/8	1/4	3/8	1/2	3/4	1	1 1/4	1 1/2	2	2 1/2	3	4
Nominal diameter DN (mm)	6	8	10	15	20	25	32	40	50	65	80	100

Material - malleable cast iron

Malleable cast iron is an iron-carbon alloy which combines the outstanding properties of cast iron (pourability) and steel (strength and ductility).

The chemical composition of the cast produces excellent castability, which makes malleable cast iron particularly suitable for making complicated shapes and producing thin walled parts.

In its cast state malleable cast iron is hard, brittle and unworkable, it only acquires its final microstructure after subsequent heat treatment known as annealing.

As a result of the annealing process (= malleabilising) very good workability and very good ductility are achieved while sufficiently high material strength is maintained.

There are two distinct types of malleable cast iron which are dependent on the annealing method. Their designation is a result of the appearance of the fracture surfaces:

1. Blackheart malleable cast iron

is annealed in an inert atmosphere (protective gas or vacuum) and has a uniform microstructure with a higher carbon content.

2. Whiteheart malleable cast iron

is annealed in an oxidising atmosphere, and in the process the carbon content of the surface zone is greatly reduced.

Due to the decarburisation of the microstructure whiteheart has a number of advantages when compared to blackheart malleable cast iron:

- **better galvanisability**
(more homogenous formation of iron-zinc-alloy at the fittings surface)
- **higher strength** with the same elongation
- a limited weldability and solderability can be achieved by additional heat treatment in the factory (see also page 78).

Hot dip galvanising

With hot dip galvanizing a zinc layer is achieved by dipping the fitting into melted (liquid) zinc. Doing so multiple iron-zinc-layers are formed at the fitting surface, which provide an optimum of adhesion of the pure-zinc-layer on top.

Galvanising is a very commonly used process for increasing the corrosion resistance of iron based materials.
Zinc is in fact a relatively base metal and corrodes quickly in the presence of oxygen, but in the process it forms a very homogeneous outer layer, which protects from further corrosion.

Georg Fischer malleable cast iron fittings are hot dip galvanised to the requirements in EN 10242, using special procedural technique ensuring that uniform coating thicknesses significantly above the norm-requirement (500 g/m² equivalent to 70 µm in average) are achieved.
Due to the use of highly pure zinc raw material continuous receiving inspections and liquid zinc inspections Georg Fischer ensures the conformity with drinking water requirements and several other regulations (e.g. RoHS)

Thread

General

Threads for pipes, valves, fittings and other pipework components which have a threaded connection are determined by international and national standards.

A basic distinction must be made between:

- **Jointing threads:**
Pipe threads where pressure tight joints are made on the threads according to **EN 10226-1/-2*** respectively ISO 7-1. The respective national issue of EN 10226 replaced DIN 2999, BS 21,
- **Fastening threads:**
Thread for joints not sealing on the threads according to **EN ISO 228-1**.

* EN 10226-2 covers the taper internal thread Rc. This type of thread is not used in Continental Europe. As it is not produced by Georg Fischer no further explanations are given.

Full designation of pipe threads

using the example of thread size 1 ½

Jointing thread to EN 10226-1

Internal thread (right-hand)	parallel	Rp 1 ½
External thread (right-hand)	taper	R 1 ½
Comment: the symbol LH is added to designate left-hand thread. Example: Rp 1 ½ - LH		

Electroplating

With electroplating zinc is deposited from an electrolyte by applying an electric current to the surface of the workpiece.

The zinc coating achieved in this way is simply a thin protection layer which is deposited on the base material (no alloy formation takes place with the base material).

The zinc coat thickness is a maximum of 25 µm. Due to the lower corrosion protection electroplated zinc surfaces are not suitable for drinking water application (see also chapter steel fittings page 74).

Difference between jointing threads/ fastening threads

The fundamental difference consists of the fact that:

- the pipe thread to **EN 10226-1** achieves a seal on the thread, mainly as a result of metallic compression (taper/parallel) of the interlocking thread surfaces in the jointing area. The sealing effect is improved by using an appropriate jointing medium.
- In contrast, the pipe thread to **EN ISO 228-1** is a purely mechanical fastening thread. Sealing of the components being connected is achieved between sealing faces with flat seat gaskets or by metal sealing surfaces.

Fastening thread to EN ISO 228-1

Internal thread (right-hand)	parallel	G 1 ½
External thread (right-hand) Tolerance class A	parallel	G 1 ½ A
External thread (right-hand) Tolerance class B	parallel	G 1 ½ B
Comment: the symbol LH is added to designate left-hand thread. Example: G 1 ½ - LH		

For external threads to EN ISO 228-1 Georg Fischer exclusively uses part of the class B tolerances (see illustr. 1).

Comparison of the tolerances of jointing and fastening threads

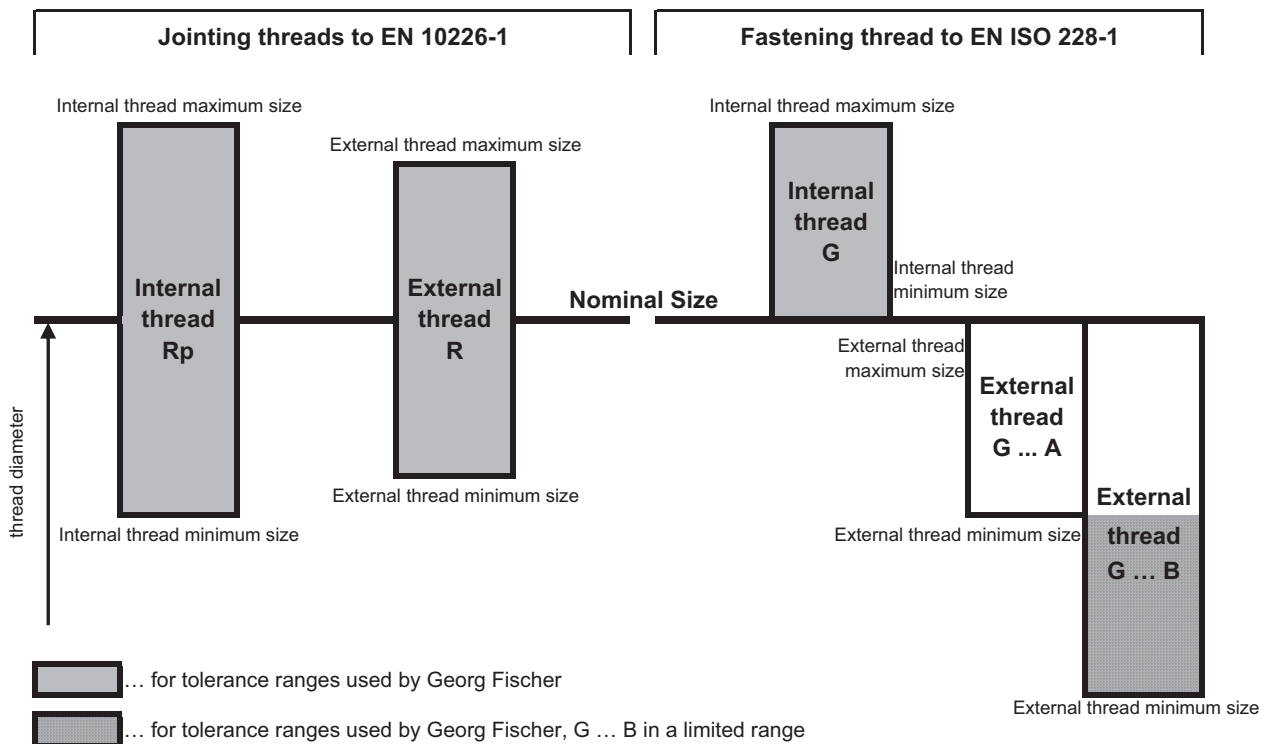

illustr. 1 Tolerances of jointing and fastening threads

Combination of jointing threads (sealing on the thread) with fastening threads (not sealing on the thread)

Connection of a parallel external thread according to EN ISO 228-1 with a parallel internal thread according to EN 10226-1: Due to the overlapping of the tolerance fields of the thread diameter (illustr. 1) of G ... A and G ... B with Rp it is not ensured that both threads can be screwed together. This can be secured by manufacturing the external thread G ... B with limited range (illustr. 1 – lower half of G ... B). Because of the missing metallic contact between the threads a sealing joint is not automatically achieved.

Connection of a taper external thread according to EN 10226-1 with a parallel internal thread according to EN ISO 228-1: Other than in the first case there is no problem in screwing both threads together / with the thread diameter. But EN ISO 228-1 does not require a minimum length of the internal thread or a fully shaped thread profile. Both may lead to sealing problems and thus has to be regulated in the norm of the product foreseeing the G - thread.

Construction and function of jointing threads (which are sealing on the threads) to EN 10226-1 (ISO 7-1)

Thread types, dimensions, tolerances and designations per thread size are specified in standard EN 10226-1 (ISO 7-1).

The most important dimensions for these jointing threads (pipe threads) and medium and heavy-duty pipes are given in the table on page 74. Illustr. 2 shows the thread profile with its most important characteristics.

For taper external threads

(illustr. 3) There are some details to be considered. The taper is in the ratio of 1:16 (illustr. 4).

The total pipe thread length consists of 3 sections:

- Gauge length "a" (illustr. 3) is specified and may vary within the tolerances. The design is such that even with the minimum possible internal thread diameter the external thread can easily be screwed in and the sparingly applied sealing material is drawn perfectly into the joint.
- Distance "b" (illustr. 3) is the thread zone which is decisive for sealing. The length of the fully formed thread roots behind the gauge plane is dedicated to provide a sufficient tightening length for the tool, even with the maximum permissible internal thread diameter; this produces tight compression between the threads due to the taper 1:16 and thus a permanently reliable seal.
- The washout thread is not fully formed at the root, and must remain visible after a joint is made. If it is screwed in too tightly, (beyond the fitting allowance) there is a risk of leakage. To avoid a leak path the crests should be fully formed towards the whole useful thread length.

For parallel internal threads

(illustr. 5) Care must be taken that the useful thread length allows the external thread to be screwed in, to achieve adequate compression and sealing, even when the external thread is at the maximum permitted gauge length.

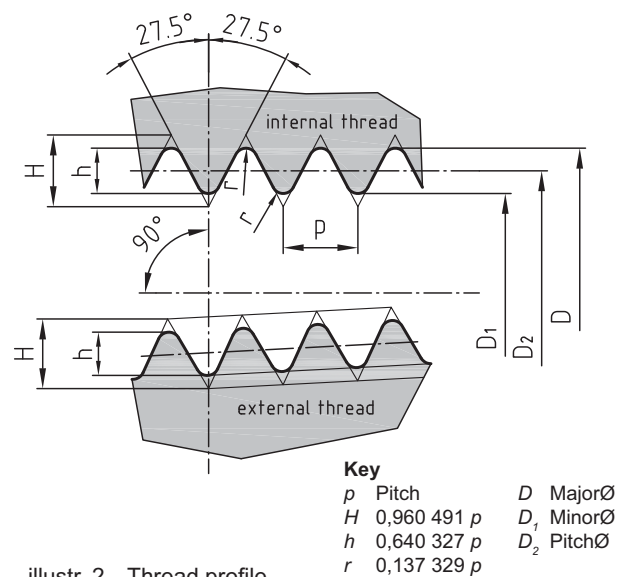

illustr. 2 Thread profile

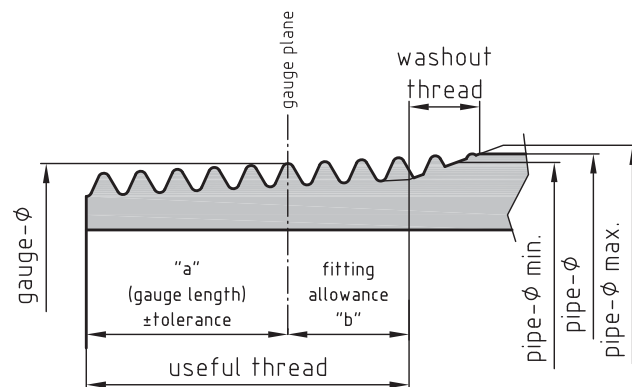

illustr. 3 Taper external thread R

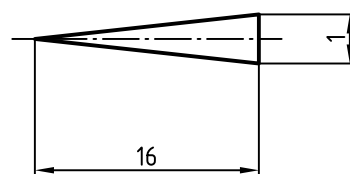

illustr. 4 Taper form of the 1:16 external thread diameter. The thread profile is at a right angle to the pipe axis.

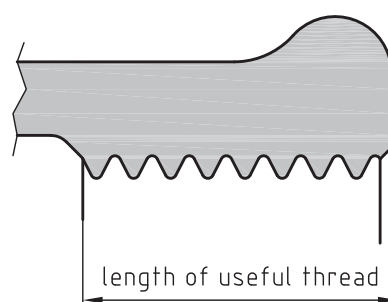

illustr. 5 Parallel internal thread Rp

As an example illustr. 6 shows a 1 inch joint with a fitting screwed on hand tight. There are still $2\frac{3}{4}$ threads available on the external thread for tightening with a wrench (see pipe thread table page 74 fitting allowance "b").

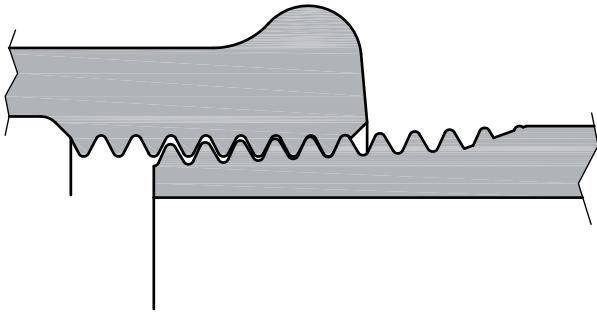

illustr. 6 Hand tight engagement

Illustr. 7 shows, the thread connection tightened according to the standard. It can be screwed together a little less or a little more to adjust the direction of the fitting's outlet (or the overall length of the pre-assembled pipeline). The connection is nevertheless perfectly pressure tight.

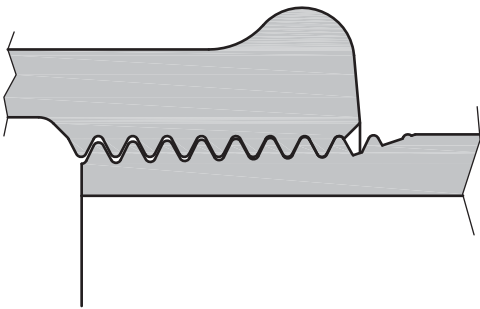

illustr. 7 Tightened with wrench

The **sealing effect on the thread** is achieved by the fact that the internal and external threads (pitch diameters) touch from the first moment of contact on and then compress when further tightened with a wrench.

Thus in a taper/parallel joint the **sealing material** only has to fill the inevitable deviations from the theoretical thread profile and roughness of the thread surfaces. Therefore only a small amount of suitable sealing material is necessary.

Tensile load, compressive stress or reversed bending stress on the joint are absorbed by the metal to metal contact.

To ensure the sealing effect of the taper/parallel joint actually takes place, the following points must be taken into account:

- The **thread cutting tool** must be adjusted so that the fitting can be screwed by hand, leaving enough thread (without sealant) for tightening with a wrench. In this way the necessary compression to achieve a seal is obtained even when the internal thread diameter is the maximum permissible.
- The end of the useful external thread (length $a + b$, see illustr. 3) should not be screwed in deeper than to the first fully formed thread of the internal thread (see illustr. 7), otherwise the compression required for sealing may be reduced by the incomplete root of the washout on the external threads.

Gauging

The inspection of both the jointing thread and the fastening thread is done with standardised plug and ring gauges.

It must be considered that gauges - inspection means comparative checking, not measuring.

Thread gauges for fastening threads:

The thread gauges used for checking fastening threads are go and no go plug gauges and/or go and no go ring gauges. These are standardised in EN ISO 228-2. To assess the dimensional conformity to EN ISO 228-1 of thin walled parts the pitch diameter must be taken as an average between two diameter measurements offset by 90° . This is e.g. the case for union nuts.

Thread gauges for jointing threads:

The thread gauges used for checking jointing threads are limit gauges, plug gauges for internal threads and ring gauges for external thread. These were standardised to EN 10226-3 in 2005, identical to ISO 7-2 of 2000. The inspection takes place with so called limit gauges, not with go and no go gauges. Essential feature of these limit gauges is to show the result of a diameter-check by projection to the length of engagement of the gauge.

The face of the test specimen indicates the result at the tolerance step of the limit gauge. Details of the gauges and the inspection procedure are described in both above mentioned norms. Additional information about an important aspect of the gauging is given in the following paragraphs.

Gauging with the character of comparative checking has an implication for parallel internal threads Rp according to EN 10226-1, especially if they are chamfered.

This is because of the thread section removed by the chamfer. The bigger the chamfer, the deeper the taper plug gauge enters in; this means the thread diameter is shown bigger at the tolerance step, than it is in reality.

The plug gauges according to EN 10226-3 and ISO 7-2 imply a chamfer, removing 1/2 pitch of the internal thread. The resulting chamfer diameter on the example of a 90° chamfer is given in the table of illustr.8.

To indicate the distortion of the gauging result by a chamfer other than 1/2 pitch Georg Fischer has developed the nomogramm illustr. 8, which should be used as follows:

The outer diameter D_a (illustr. 8) of the thread chamfer is measured first. Then a straight line is drawn on the nomogram to join the points corresponding to the thread size and the measured diameter (D_a). The point of intersection of this straight line with the n axis, indicates the number of necessary correction revolutions n.

Correction is carried out by retracting the plug gauge by n revolutions, back from the hand tight position. The new position of the plug gauge indicates the actual size of the internal thread diameter.

Example:

On the elbow 90- 3/4 G a chamfer diameter of ($D_a=$) 28.2 mm was measured. By joining the points $D_a= 28.2$ and 3/4, and extending the line $n = 1/4$ is read on the n axis.

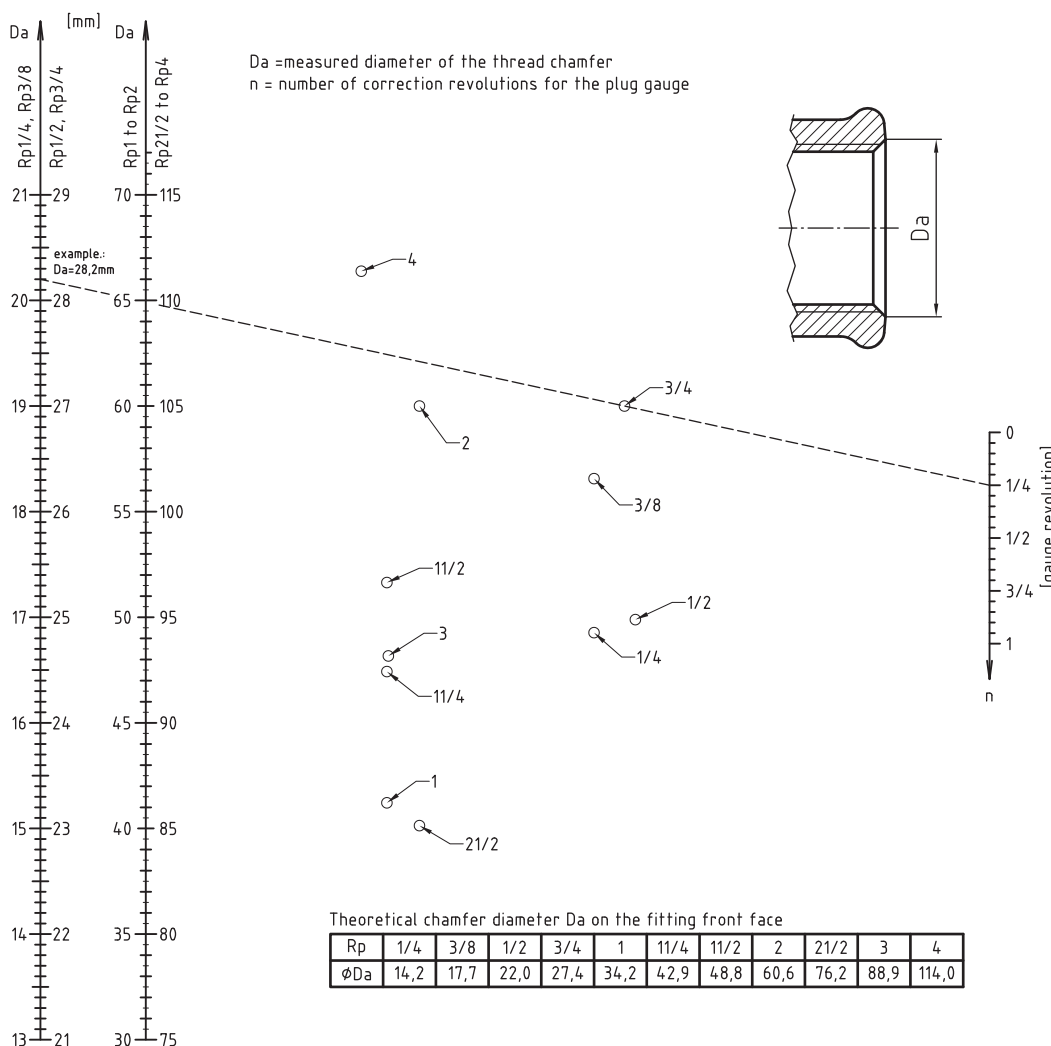

illustr. 8 Nomogram (to be reproduced only with the express permission of Georg Fischer)

Pipe threads (EN 10226/ISO 7) and threaded pipes (EN 10255/ISO 65)

The most important dimensions

Thread size		1/8	1/4	3/8	1/2	3/4	1	1 1/4	1 1/2	2	2 1/2	3	4
Nominal diameter DN		6	8	10	15	20	25	32	40	50	65	80	100
Pipe threads													
Plug gauge diameter (thread external diameter in the measuring plane)	mm	9,728	13,157	16,662	20,955	26,441	33,249	41,910	47,803	59,614	75,184	87,884	113,030
Pitch	mm	0,907	1,337	1,337	1,814	1,814	2,309	2,309	2,309	2,309	2,309	2,309	2,309
Number of threads per inch		28	19	19	14	14	11	11	11	11	11	11	11
Gauge length «a» (external thread)	mm	4,0	6,0	6,4	8,2	9,5	10,4	12,7	12,7	15,9	17,5	20,6	25,4
Tolerance for «a»	mm	± 0,9	± 1,3	± 1,3	± 1,8	± 1,8	± 2,3	± 2,3	± 2,3	± 2,3	± 3,5	± 3,5	± 3,5
Fitting allowance «b»	mm	2,5	3,7	3,7	5,0	5,0	6,4	6,4	6,4	7,5	9,2	9,2	10,4
Number of threads pitch length [ca.=approx.]	ca. mm	7,0	10,0	10,0	13,0	15,0	17,0	19,0	19,0	24,0	27,0	30,0	36,0
Threaded pipes													
Outside diameter	mm	10,2	13,5	17,2	21,3	26,9	33,7	42,4	48,3	60,3	76,1	88,9	114,3
Surface area of the pipe	ca. m ² /m	0,032	0,042	0,054	0,067	0,085	0,106	0,133	0,152	0,189	0,239	0,279	0,359
Medium duty													
Wall thickness	ca. mm	2,0	2,3	2,3	2,6	2,6	3,2	3,2	3,2	3,6	3,6	4,0	4,5
Inside diameter	ca. mm	6,2	8,9	12,6	16,1	21,7	27,3	36,0	41,9	53,1	68,9	80,9	105,3
Clear opening	ca. cm ²	0,30	0,62	1,25	2,04	3,70	5,85	10,18	13,79	22,15	37,28	51,40	87,09
Capacity	ca. l/m	0,030	0,062	0,125	0,204	0,370	0,585	1,018	1,379	2,215	3,728	5,140	8,709
Pipe mass, plain end black pipe	ca. kg/m	0,40	0,64	0,84	1,21	1,56	2,41	3,10	3,56	5,03	6,42	8,36	12,20
Heavy duty													
Wall thickness	ca. mm	2,6	2,9	2,9	3,2	3,2	4,0	4,0	4,0	4,5	4,5	5,0	5,4
Inside diameter	ca. mm	5,0	7,7	11,4	14,9	20,4	25,7	34,4	40,3	51,3	67,1	78,9	103,5
Clear opening	ca. cm ²	0,19	0,47	1,02	1,74	3,27	5,19	9,29	12,76	20,66	35,36	48,89	84,13
Capacity	ca. l/m	0,020	0,047	0,102	0,174	0,327	0,519	0,929	1,276	2,066	3,536	4,889	8,413
Pipe mass, plain end black pipe	ca. kg/m	0,49	0,77	1,02	1,44	1,87	2,93	3,79	4,37	6,19	7,93	10,30	14,50

For details see the relevant standards

Length tolerances

The permitted length tolerances for standardised types of fittings are given in the table below.

For straight parts (nipples, sockets, etc.) the tolerance refers to the face to face dimension.

For fittings with changes of direction (bends, elbows, tees) the tolerance refers to the face to centre (axis) dimension.

The stated tolerances for **unions** are referring to the individual union parts and not to the complete fitting.

Length tolerance Dimensions in mm

Dimensions (overall lengths)	tolerance
to 30	± 1,5
over 30 to 50	± 2,0
over 50 to 75	± 2,5
over 75 to 100	± 3,0
over 100 to 150	± 3,5
over 150 to 200	± 4,0
over 200	± 5,0

Angle tolerance

The axis of the fitting threads may deviate by a maximum of 0.5° from the specified angle.

Width across flats for malleable iron fittings

The catalogue section gives the sizes of wrenches required.

Steel fittings

Some fittings up to max. 3/8 inch with straight design are exclusively offered by Georg Fischer in steel material. This option is foreseen by EN 10242, because of (casting-) technological reasons. These steel fittings are marked with "ST" in the catalogue section. For technical reasons the zinc coating of the steel fittings is done by electroplating. Galvanised steel fittings are therefore not suitable for drinking water installations. Georg Fischer steel fittings (apart from cat. nos. 290, 291, 531, 596) can be recognised by a code groove on the hexagon.

Union fittings

Flat seat unions

Flat seat unions are supplied without sealing gaskets (except fig. 350, 351, 356, 599a). The overall lengths and z dimensions refer to the assembled union with a sealing gasket 2 or 3 mm thick (see page 80 for sizes of sealing gaskets). The choice of a suitable sealing ring material depends on the working requirements. During production pressure tests are only carried out on the piece parts (union ends and union bushes).

Flat seat unions can be dismantled completely and reassembled (see illustr. 9).

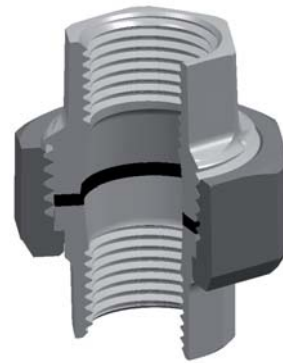

illustr. 9 Flat seat union Fig. 330

Flat seat service unions

The service union enables an easy mounting and dismantling of piping components (filters, check valves, regulating valves, heat exchangers, ...) of a piping system.

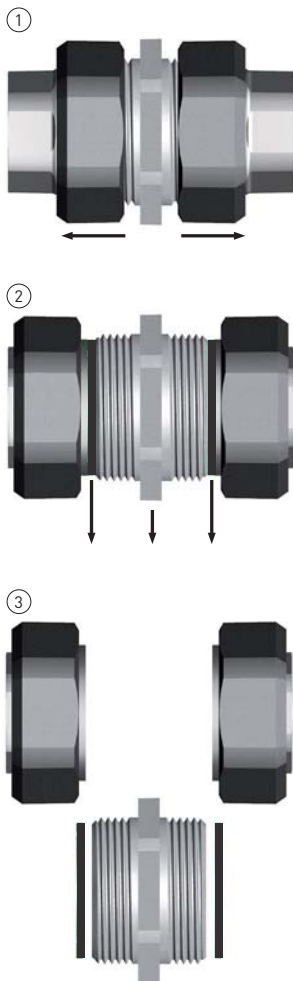

illustr. 10 Dismantling of service union fig. 350

At the installed service union it is possible to dismantle the union bush radially (see illustr. 10) by unscrewing the union nuts. Thus creates space for dismantling the following component unproblematically. The union bush is longer than the thread length of a jointing thread Rp and R (according to EN 10226-1). As soon as the part is removed the space, which is needed to dismantle the following component completely, is available.

Up to present 2 conventional unions have been used – before and behind the piping component considered for dismantling. In comparison to this the shorter overall length of the service union saves space, and additionally time, as one threaded connection (sealing) less needs to be made.

Using the service union a good accessibility with the tool is only necessary at one position (no longer before and behind the dismantled component).

Due to the availability of versatile versions internal-/internal thread, internal-/external thread and external-/external thread (see page 54) the service union can be used in all imaginable situations.

2 gaskets suitable for the most common media (natural gas and LP gas, compressed air, oil and heating water) till 150°C/25 bar are supplied together with the service union.

Thus the service union is an ideal disconnecting joint (detachable connection) at a fixed assembled pipes that can be used for the purpose of new construction of a system or in existing ones for extension of the system or repairs.

Taper seat unions

Before use, seats of metallic sealing unions must be cleaned and lubricated. For potable water applications lubrication must be done with a potable water-approved non hardening thread sealant (e.g. thread sealing paste according to DIN 30660).

If taper seat unions are reused, Georg Fischer do not take over a warranty for the sealing performance.

Conical/spherical and spherical sealing seat unions

Fig. 342 and 342a offer high sealing efficiency due to specially formed sealing surfaces. Fig. 346 with spherically produced sealing surfaces allows a smooth angular movement from 0 to 6°.

Limits for the use of fig. 342, 342a and 346 see page 77. Fig. 342 and 342a are not suitable for use in drinking water installations.

Guideline for tightening taper seat unions fig. 340, 341 and 344 (Final assembly) valid also for fig. 342, 342a, and 346

Fitting size	1/8	1/4	3/8	1/2	3/4	1	1 1/4	1 1/2	2	2 1/2	3	4
Tightening torque Nm	15	20	30	50 **) 60	65 **) 80	80 **) 100	150	180	240	310	350	470
max. allowable revolutions *)	1/4	1/4	1/4	1/4	1/2	1/2	1/2	1/2	1/2	1/2	1/2	1/2

*) maximal nut-revolutions after hand-tight fastening

**) deviating tightening torques for 342, 342a and 346

Union piece parts

Most Georg Fischer flat seat union piece parts are available as «spare parts» (refer to chapter Product Range).

Piece parts of unions with metallic sealing, should not be exchanged or reused. Metallic sealing union piece parts are therefore only offered after technical clarification.

The dimensions of cast on flanges respectively seats of both, flat seat and metallic sealing union piece parts, are not standardised, neither on European nor on International level. They are subject to a works standard, which may be revised for technical reasons. Georg Fischer does not grant warranty for pressure tightness, if piece parts are exchanged or reused especially in connection with other brands and for re-use of unions with metallic sealing.

Application notes

Range of application

Malleable cast iron fittings are used for conveying liquids and gases up to the pressure and temperature limits specified in standard ISO 49 and EN 10242. Fittings and union piece parts are tested individually for leak tightness. The test pressures are above the values stipulated in the standard. Unless otherwise specified (see specially pressure tested fittings), the following working pressures and temperatures apply for the parts in the Georg Fischer range of malleable iron fittings.

Working temperature °C *)	Maximum permissible working pressure bar **)
-20 up to 120	25
between 120 and 300	interpolated values
300	20

*) The values are fluid temperatures under continuous operation conditions. Applications with specific environment temperatures require further technical assessment.

**) 1 bar = 10⁵ N/m² = 100 kPa

Standardisation and certification

Georg Fischer actively participates in international product- and application-related standardisation and important national standardisation projects. An active handling of actual and prospective regulations is of high importance as well.

The Pressure equipment directive 2014/68/EU, the construction product regulation No. 305/2011, RoHS-Directive 2011/65/EU and REACH can be mentioned as example. Actual information and if required conformity declarations are available at

www.fittings.at/contactform



Georg Fischer holds national approvals for important applications, especially gas and drinking water installations. Articles which have the international FM approval for fire extinguishing systems are listed at page 67.

The actual certificates/approvals are shown at

www.fittings.at/approvals

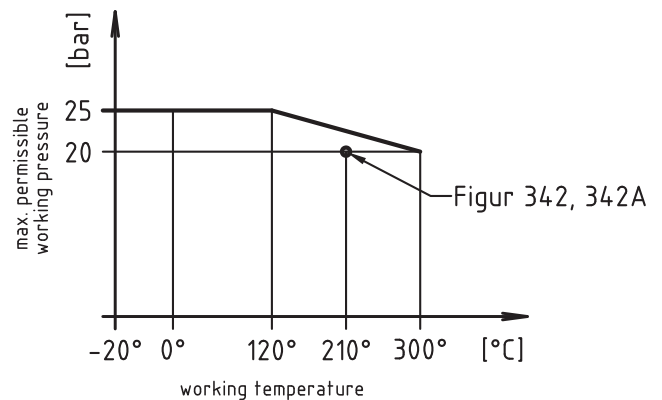

Exceptions:

Figure 342, 342a max. 210°C / max. 20 bar
Figure 346 max. 300°C / max. 20 bar

Installations of malleable iron fittings

The limits of use for specific applications can be found in international, European and national guidelines (e.g. norms, rules, regulations of regional supply companies etc.).

Specially pressure tested fittings

Fittings for higher working pressures than 25 bar are available on request in the dimension range from 3/8 to 3.

They are subjected to a separate individual test (at 100 bar test pressure), they are marked with yellow colour and the letter "P".

A test report acc. to EN 10204 is available on request.

Type tested fittings

These fittings are mainly used in gas-high pressure fire extinguishing systems according to the German VdS-Rules. **A type test** is carried out on fitting samples. The fitting body must withstand a pressure of 300 bar without bursting. (Attention: These test pressure should not be mixed up with the permissible working pressure).

Before delivery these parts are subjected to a separate individual pressure test, they are marked with red colour and with the letter "D".

A test report acc. to EN 10204 is available on request.

There is only a limited range of Georg Fischer malleable iron fittings available as type tested fittings. The list of type tested fittings is available on request.

Drinking water installations with hot dip galvanised malleable iron fittings

All other fittings than the ones marked with "ST" in the catalogue section, are hot dip galvanised in accordance with EN 10242 (and ISO 49). The protective layer formed by hot dip galvanizing consists of several iron-zinc alloy layers covered by a layer of pure zinc. During the first period of operation the reaction with the drinking water forms a homogenous protective layer. In the normal case of the positive cooperation of the influencing criteria the outer layer formation is accompanied by the natural removal of the pure zinc layer. To achieve this formation and to prevent corrosion damages different requirements, described in EN 12502-3 must be fulfilled.

Summarising the above norm the mayor influencing criteria must be taken into account:

- material property
- water quality
- operation conditions
- design and installation of the pipework system

Aiming hygienic conditions for drinking water the German DIN 50930 has defined additional requirements in its last edition of October 2013. These requirements on the one hand refer to the chemical composition of the zinc layer and on the other hand to the water conditions. Malleable cast iron fittings and steel pipes are grouped under the term "hot dip galvanised iron materials".

According to DIN 50930-6:2013-10 hot dip galvanised materials are applicable if the drinking water fulfils the following criteria:

$K_{B8,2} \leq 0,20$ mmol/l and coefficient S_1 according to DIN EN 12502-3 < 1 .

For unavoidable accompanying elements in the zinc layer for malleable cast iron fittings it is defined:
 $Pb \leq 0,1$ %, $Bi \leq 0,01$ %, $Cd \leq 0,01$ %, $As \leq 0,02$ % and $Sb \leq 0,01$ % (for steel pipes applies $Pb \leq 0,05$ %).

By using highly pure raw-zinc and continuous inwards inspections and zinc bath analysis, Georg Fischer ensures the fulfilment of these high requirements for the zinc layer.

Reusability of dismantled fittings

When the threaded joint between fittings and threaded pipes is correctly made, no permanent deformation of fittings occurs and the fittings may be reused.

In contrast to that permanent deformation of the external thread at the pipe occurs. Therefore pipes should not be reused after dismantling.

Taper (metallic) seat unions and union piece parts see page 76.

Welding and brazing

The EN-GJMW-400-5 material used for Georg Fischer fittings is not ideal for welding and brazing.

The chemical analysis of this material differs from weldable materials especially in the silicon, sulphur, manganese and carbon content.

The conditions necessary for welding or brazing are a maximum carbon content of 0.3% which can be achieved with an additional heat treatment. Elongation values are established approximately as required for welding and brazing qualities - measured on a 9 mm test bar.

In summary the Georg Fischer EN-GJMW-400-5 material is only **suitable** for welding or brazing after additional heat treatment. After this **additional** heat treatment we recommend that on welding applications welding tests are carried out on test components to ascertain whether the required standards have been met. This is important for welded connections because compared with soldering, changes in the microstructure are greater because of the higher temperatures during welding.

In either case, apart from material specific instructions further constructive and process engineering conditions are required in case of welding and brazing joints.

Sealing material

Sealing material for thread connections

In a taper/parallel threaded joint, the sealing material has the task of filling in unavoidable deviations from the theoretical thread profile, and roughness at the thread surface. Tensile load, compressive stress or reversed bending stress on the joint is absorbed by the metal to metal contact.

Only permitted sealing materials should be used to seal threads on potable water and gas installations. Testing of sealing agents is carried out according to EN 751 : Part 1 - anaerobic jointing compounds, Part 2 - non-hardening jointing compounds, Part 3 - unsintered PTFE tapes.

The alignment of already assembled fittings sometimes requires turning back of taper/parallel joints up to a maximum of 45°. To assure that sealing materials meets these requirement in countries where this procedure is practiced, an additional test criteria has been imposed by EN 751-2.

Those sealing materials additionally have to be marked with "Rp".

With regard to the technical application (gas, heating system, ...) national regulations have to be considered. Supplementary to EN 751-2 for drinking water installations e.g. the German DIN 30660 – established due to a lack of international regulations – defines requirements with regard to hygienic aspects. As a general rule, tests carried out for national approvals/certificates are based on the norm requirements above.

Sealing materials have to be chosen according to the working conditions of the application. If no experience in this field has been made, the below table may serve as guideline.

In any case the working limits given by the sealing material manufacturer have to be considered.

Connections on gaslines and pipelines for higher pressure requirements call for special care. For other application fields the relevant regulations on the use of thread connections must be complied with.

sealing material	hemp with sealing compound	PTFE teflon standard sealing tape / PTFE sealing cord	PTFE teflon special sealing tape **)	Polyamid-cord impregnated with sealing compounds	anaerobic sealing compounds
medium					
Thread size	1/2 - 4	1/2 - 1 1/4	1/2 - 2	1/2 - 4	1/2 - 2 1/2 3 - 4
drinking water up to 60°C	●	●	●	●	● ○
waters within a system up to 130°C *)	●	●	●	●	● ○
natural gas, town gas and liquid gases	●	●	●	●	● ○
compressed air oiled and unoiled	●	●	●	●	● ○
steam up to 150°C	-	●	●	○	● ○
up to 200°C	-	-	●	-	● ○
up to 250°C	-	-	●	-	- -
heating and diesel oils, petrol max. 80°C	-	●	●	-	● ○
hydraulic oils up to 200°C	-	●	●	-	○ ○

● suitable ○ conditionally suitable - unsuitable

*) water for firefighting and waters within a system (in closed circuit systems inducted drinking water e.g. water in hot water heating, without chemical additives)

**) thick teflon tapes (with large area-related mass)

Sealing Gasket Dimensions (Gaskets should be sourced from specialist suppliers)

Jointing thread Fitting size R/Rp	Fastening thread G	Gasket Inside diameter x Outside diameter	Thickness	For complete unions (and/or regulation sockets and plugs) Catalogue number															
				95	97	100	101	330	331	332	335	336	338	350	351	356	595	599a	
1/4	5/8	13x20	2					●	●										
3/8	3/4	17x24	2	●	●			●	●										
1/2	3/8	17x24	2															■	
1/2	1/2	22x30	2														●		
1/2	1	21x30	2	●	●	●	●	●	●	●	●	●	●	■	■	■			
1/2	1 1/8	24x34	2																
3/4	1/2	21x28,5	2															■	
3/4	3/4	27x36	2							○							●		
3/4	1 1/4	27x38	2	●	●	●	●	●	●	●	●	●	●	■	■	■			
1	3/4	26,5x34,5	2															■	
1	1	34x43	2							○							●		
1	1 1/2	32x44	2	●	●	●	●	●	●	●	●	●	●	■	■	■			
1 1/4	1 1/4	43x53	2							○									
1 1/4	1 1/8	38x48	2															■	
1 1/4	2	42x55	2	●	●			●	●	●	●	●	●						
1 1/2	1 1/4	42x52	2															■	
1 1/2	1 1/2	48x60	2							○									
1 1/2	2 1/4	46x62	2	●	●			●	●	●	●	●							
2	1 3/4	54x64	3															■	
2	2	61x73	3							○									
2	2 3/4	60x78	3	●	●			●	●	●									
2 1/2	3 1/2	75x97	3					●	●										
3	4	88x110	3					●	●										
4	5	115x135	3					●											

- recommended gasket ○ recommended gasket for figure no. 373 for the middle plane face
- gaskets supplied

Jointing thread R/Rp	Nominal diameter, DN	Gasket (inside diameter x Outside diameter) can be used for flanges, catalogue number	
		326	329
1/2	15	22 x 43	24 x 51
3/4	20	28 x 53	30 x 61
1	25	35 x 63	36 x 71
1 1/4	32	43 x 75	45 x 82
1 1/2	40	49 x 85	49 x 92
2	50	61 x 95	61 x 107
2 1/2	65	77 x 115	77 x 127
3	80	90 x 123	90 x 142
4	100	115 x 152	115 x 162

Basically gaskets are not supplied along with the unions, as there are various applications they are used for and the appropriate gasket material has to be chosen for the relevant working conditions.

As exception unions no. 350, 351, 356 and the regulation socket 599a (plug with gasket) are supplied with gaskets of the sizes specified above. Specification of the gasket material can be given on request.

Guideline for distance between support brackets on steel pipelines

Jointing thread	Steel pipes	
	Nominal diameter DN	Distance between brackets m
3/8	10	2,25
1/2	15	2,75
3/4	20	3,00
1	25	3,50
1 1/4	32	3,75
1 1/2	40	4,25
2	50	4,75
2 1/2	65	5,50
3	80	6,00
4	100	6,00

Heat expansion in steel pipelines

Any temperature change in a pipeline results in a change in length, which can cause considerable stresses on the joints, fastening elements, the structural parts, appliances and plumbing fixtures. Although the heat expansion of steel is low compared to other piping materials, it must be taken into account for design and installation (compensation joints, compensators, ...).

A difference in temperature of 100 K (°C) will cause a 1 m steel pipe to expand by round 1.2 mm. Changes in length Δl of steel pipelines can be read from the table or can be calculated using the formula below. Usually the critical difference in temperature ΔT is the difference between the maximum working temperature and the temperature on installation.

Formula for calculating the change in length:
 $\Delta l \text{ [mm]} = 0,012 \times l \text{ [m]} \times \Delta T \text{ [K or } ^\circ\text{C]}$

Changes in length of steel pipes due to differences in temperature

Pipe length l [m]	Difference in temperature ΔT [K or °C]									
	10	20	30	40	50	60	70	80	90	100
	Change in length Δl [mm]									
1	0,12	0,24	0,36	0,48	0,60	0,72	0,84	0,96	1,08	1,20
2	0,24	0,48	0,72	0,96	1,20	1,44	1,68	1,92	2,16	2,40
3	0,36	0,72	1,08	1,44	1,80	2,16	2,52	2,88	3,24	3,60
4	0,48	0,96	1,44	1,92	2,40	2,88	3,36	3,84	4,32	4,80
5	0,60	1,20	1,80	2,40	3,00	3,60	4,20	4,80	5,40	6,00
6	0,72	1,44	2,16	2,88	3,60	4,32	5,04	5,76	6,48	7,20
7	0,84	1,68	2,52	3,36	4,20	5,04	5,88	6,72	7,56	8,40
8	0,96	1,92	2,88	3,84	4,80	5,76	6,72	7,68	8,64	9,60
9	1,08	2,16	3,24	4,32	5,40	6,48	7,56	8,64	9,72	10,80
10	1,20	2,40	3,60	4,80	6,00	7,20	8,40	9,60	10,80	12,00
11	1,32	2,64	3,96	5,28	6,60	7,92	9,24	10,56	11,88	13,20
12	1,44	2,88	4,32	5,76	7,20	8,64	10,08	11,52	12,96	14,40
13	1,56	3,12	4,68	6,24	7,80	9,36	10,92	12,48	14,04	15,60
14	1,68	3,36	5,04	6,72	8,40	10,08	11,76	13,44	15,12	16,80
15	1,80	3,60	5,40	7,20	9,00	10,80	12,60	14,40	16,20	18,00
16	1,92	3,84	5,76	7,68	9,60	11,52	13,44	15,36	17,28	19,20
17	2,04	4,08	6,12	8,16	10,20	12,24	14,28	16,32	18,36	20,40
18	2,16	4,32	6,48	8,64	10,80	12,96	15,12	17,28	19,44	21,60
19	2,28	4,56	6,84	9,12	11,40	13,68	15,96	18,24	20,52	22,80
20	2,40	4,80	7,20	9,60	12,00	14,40	16,80	19,20	21,60	24,00

Planning of Piping Systems

Sketching of pipework

Clear sketching of pipework

The isometric diagrams of pipes and horizontal projections are ideal for quick preparation when using the Georg Fischer installation method.

The drawing of the pipework should be given in a simple but effective way. The diagrams can be sketched by the installer himself on the spot.

This type of representation enables quick outlining with no aids such as ruler, set square etc. either directly on the site of installation or according to a plan. The pipework system to be installed is always clearly recognisable with all necessary fittings, valves etc.

The 30° pipeline diagram (3D plan) is intentionally not drawn to scale, i.e. long pipe sections are made shorter, short pipe sections are to a large extent made somewhat longer. In this way even extensive pipe systems can be represented on an A4 sheet of paper.

Pipelines running at right angles to each other are drawn as shown below:

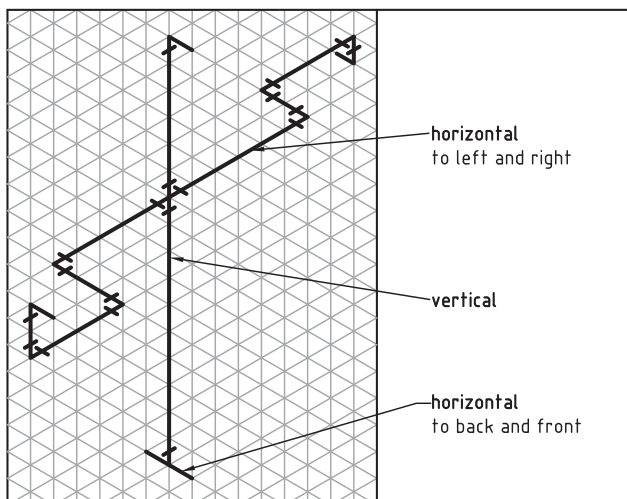

Pipelines sloping in relation to each other are drawn as shown in the example below:

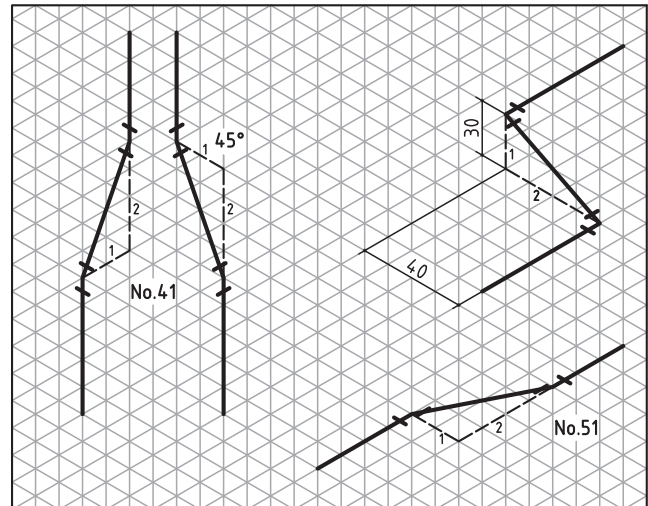

Changes of direction are shown in the ratio of 2:1 or 1:2 irrespective of angles and dimensions. By drawing in the triangle as an aid the change of direction is set accurately. The divergence is established by giving the type of fitting (catalogue no. or angle) or by dimensioning.

Fittings and/or jointing points can be marked with a small dash, valves with the standardised symbols.

The most important symbols for drawing of pipe work on the **Georg Fischer** pipe layout chart:

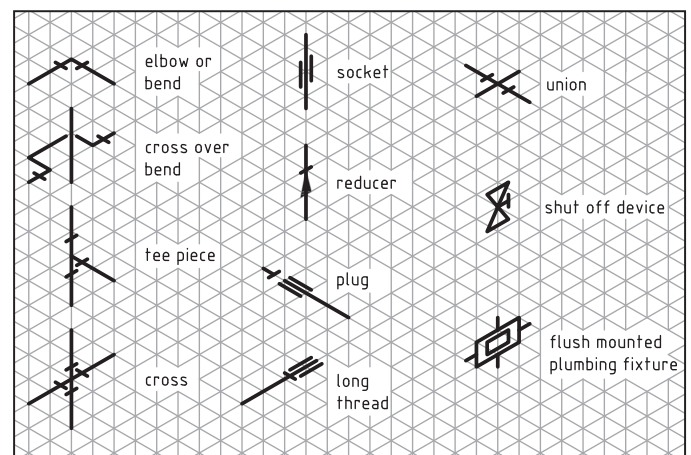

The Georg Fischer pipe layout chart

The 30° pipeline diagram can be drawn on the Georg Fischer pipe layout chart, for example. The oblong format selected is particularly suitable for use on the site. The area available for sketching, either allows sections of pipelines to be portrayed, or even more extensive part installations (e.g. cellar quantization, floor distributors) to be reproduced.

The advantages of the Georg Fischer pipe layout chart are obvious:

- splitting in different steps of pipe installation possible
- quick drawing of a sketch

- clear collection of centre to centre dimensions
- easier calculation of tube lengths
- basis of the material bill
- basis for the calculation and invoicing
- offers a clear rationalisation effect: all tubes with same dimension can be measured, marked, cut and threaded in one go
- Stored together with the project documentation the sketches allow a clear tracing of the pipe layout even after years. Hence supports easier pipe work extensions and repair.

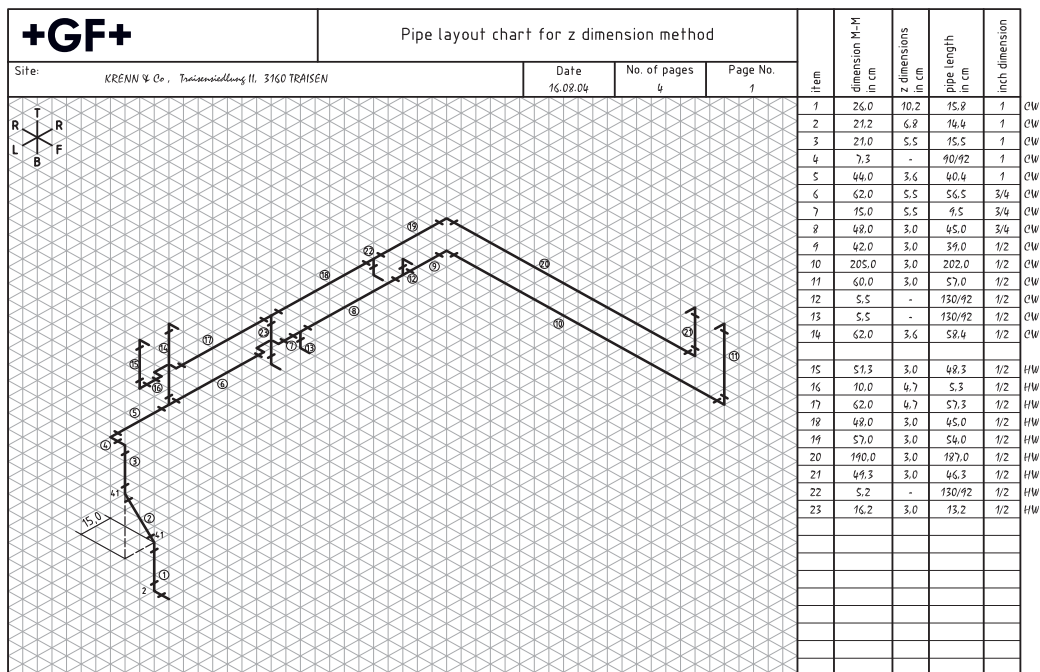

A master copy of the Georg Fischer pipe layout chart can be found on page 96.

Pipework in CAD

The planning tool used most by the Georg Fischer customers is the CAD-Library. It offers export of the whole malleable cast iron fittings assortment and the related standardised steel pipes in various CAD formats.

The fittings geometries in various 2D and 3D formats can be exported directly (without saving the files, using direct interfaces) from the CAD library to the most popular CAD software in order to design the pipe layout there.

The fittings geometry is marked at the internal thread with the length of (thread-)engagement according to z-measures of EN 10242. Product data accompany the fittings geometry and can be used for the material bill of the CAD-System.

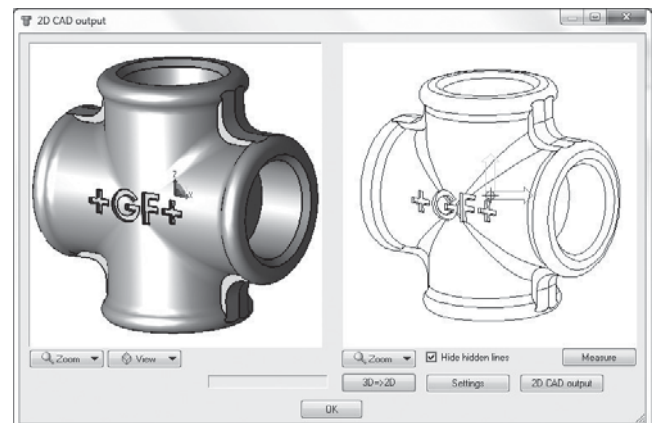

CAD Library for malleable cast iron fittings can be requested at:

www.fittings.at/cad-library



z dimension method

Introduction

The z dimension installation method, developed by Georg Fischer in conjunction with experienced installers of domestic and industrial piping systems, has been proving its worth for years in practical applications. The method offers a basis for efficient planning, preparation for work and preliminary assembly and can result in savings in time and effort:

- staff use can be reliably planned
- administrative work more easily completed
- calculation and costing simplified
- optimised machine use
- reduction of fittings and tube stock
- optimisation of transportation, elimination of material-related non-productive time
- the pipeline layout can easily be recognized by the pipeline diagram.

Requirements

The z dimension method relies on:

- knowledge of the pipeline layout
- knowledge of the space requirements of valves, appliances and their locations.
- co-ordination with architect, planner, works management and the other businesses who work may have an influence on the pipeline layout.
- use of fittings with consistent dimensional accuracy, such as **Georg Fischer's**.
- compliance with the standardised measurements (conforming thread length and diameter) at the tubes manufactured on site, implying combined exact adjustment of the threading machine

Length of engagement

The nominal engagement length of the pipe external thread are according to EN 10242 / ISO 49 (rounded values):

Joint size	Average length of engagement in mm
1/8	7
1/4	10
3/8	10
1/2	13
3/4	15
1	17
1 1/4	19
1 1/2	19
2	24
2 1/2	27
3	30
4	36

Note:

The laying length (z dimension) derives from the average length of engagement according to EN 10242 (ISO 49) shown in the table above.

Practise shows divergences to the average standard values related to the different sealing materials. Especially for bigger joint sizes shorter lengths of engagement (= bigger z dimensions) might occur, which may differ round 2mm for 1 1/4 and 1 1/2, and 4mm for the sizes bigger than this. It is recommended to establish test assemblies with the sealing material in question to allow proper correction of the tube lengths calculation by correction of the z measures.

z dimension and method of measuring for pipe prefabrication

z dimension

The z dimension - also called «laying length» is the middle distance between

- installed pipe end and the axis of the fitting or
- the ends of two installed pipes

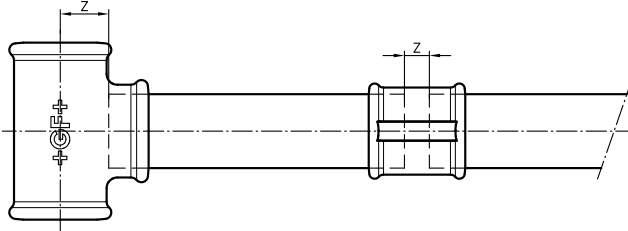

The z dimensions are calculated from the overall lengths less the average length of engagement. z dimensions were introduced by Georg Fischer to support the rational planning and preparation of work.

The z dimension is calculated as the difference between «dimension face - middle» (a, b or c) and length of engagement of the pipe thread.

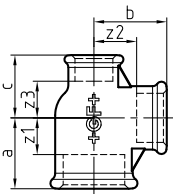

For fittings, e.g. tee no. 130, reduced branch and run:
 $z_1 = a$ - length of engagement
 $z_2 = b$ - length of engagement
 $z_3 = c$ - length of engagement

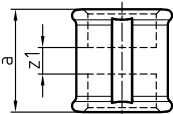

Exception - socket no. 270, 271:
 $z_1 = a - 2$ length of engagement

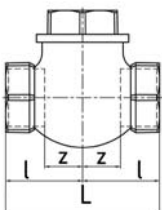

For valves:
 $z = l$ - length of engagement
 If the total overall length is indicated by L, the following applies:

$z = L / 2$ - length of engagement

How to measure

z dimension and consistent method of measuring are the core of the Georg Fischer installation method.

The z dimension is the pipe installers «design dimension». With this tool he can easily calculate the exact pipe length between fittings and/or valves. The principle of

standardised measuring centre - centre = M

forms the basis for determining and using the z dimension.

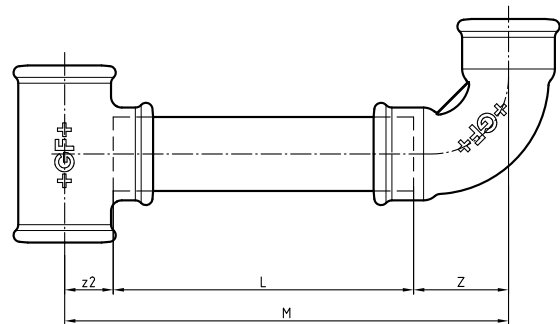

Pipe length $L = M - (z_2 + z)$

z dimension and combinations of fittings

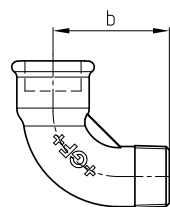

Fittings with external thread:
 b is the distance of internal thread centre to face of the external thread.

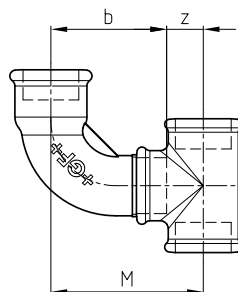

For fittings combinations with internal and external threads the distance of the axes arises from adding $z + b$:

$M = z + b$

Examples of use

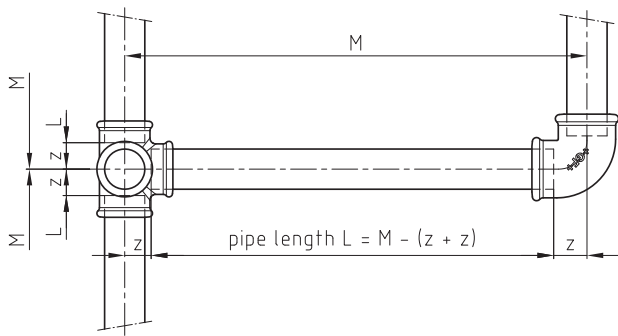

Principle of the z dimension method: consistent method of measuring centre - centre = M

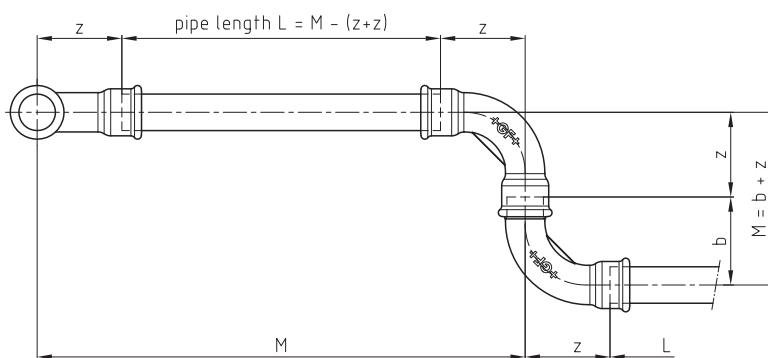

Exact pipe thread lengths produce exact M dimensions.

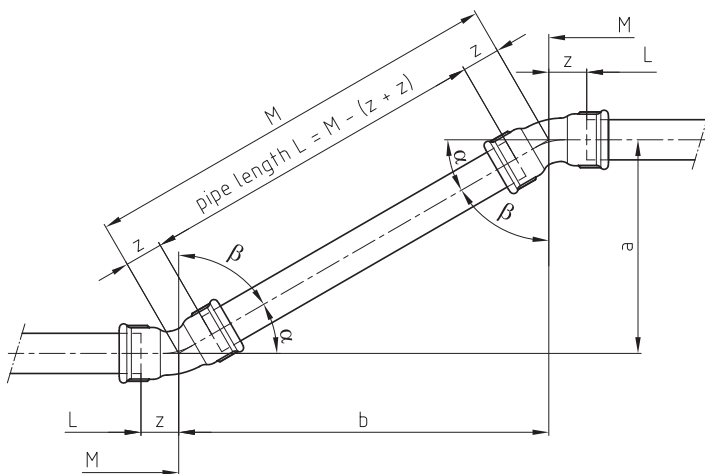

The M dimension for sloping pipe sections can easily be calculated by using the factor table or the numerical table.

Calculation of the length of sloping pipelines

Parts of a pipeline diverging from the horizontal and verticals can only be accurately marked out in a few cases. Accurate results are obtained by rectangular measuring and determining the remaining (triangle) side lengths.

There are two possibilities for calculating the pipe lengths by means of the z dimensions:

1. Factor table

given:		a		b	
α	β	Factor for		Factor for	
		b	c = M	a	c = M
75°	15°	0,268	1,035	3,732	3,864
60°	30°	0,577	1,155	1,732	2,000
45°	45°	1,000	1,414	1,000	1,414
30°	60°	1,732	2,000	0,577	1,155
15°	75°	3,732	3,864	0,268	1,035

- α = given angle
- β = accompanying angle
- angle-dependent factors multiplied with the given dimension a or b = sought dimensions b and c or a and c.

Example:

a = 28,5

$\alpha = 45^\circ$

$c = M = 28,5 \times 1,414$

$= 40,3$

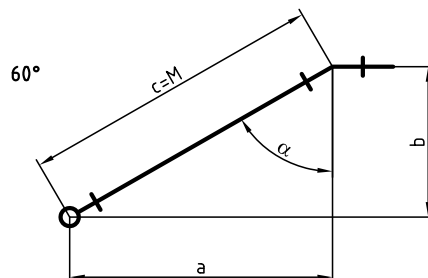
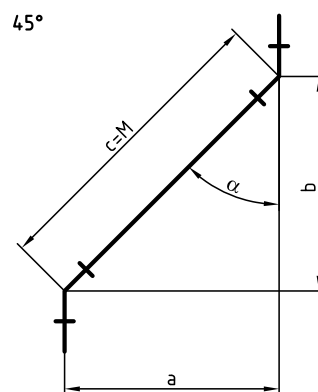
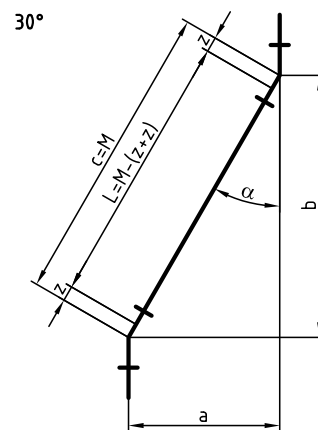

2. Numerical table

see table page 89.

Example:

Displacement of pipe axis at a riser.

Dimensions M, M1 and a are measured on site, all other dimensions are calculated by using the numerical table.

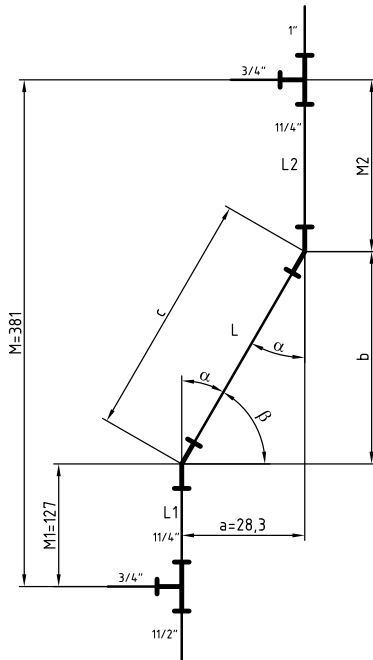

Planned fittings (from bottom to top):

1 tee no. 130 - 1 1/2 x 3/4 x 1 1/4

2 bends no. 51 - 1 1/4 (30°)

1 tee no. 130 - 1 1/4 x 3/4 x 1

The projection a is 28.3 cm = 283 mm.

283 consists of 3 + 80 + 200. In columns b and c we find the partial values belonging to 3, 80 and 200 for the perpendiculars b and the slopes c.

In this case lengths b and c result from adding up the partial values $\alpha = 30^\circ$, $\beta = 60^\circ$.

a (known)	b	c
3 mm	5,2 mm	6 mm
80 mm	138,6 mm	160 mm
200 mm	346,4 mm	400 mm
283 mm	490.2 mm	566 mm
or a=28.3 cm	b=49.0 cm	c=56.6 cm

Calculation of pipe length L:

Pipe length $L = c - (2 \times z \text{ dimension of bend no. 51} - 1 \frac{1}{4})$

z dimension bend = 33 mm = 3.3 cm

$$L = 56.6 - (2 \times 3.3) = 56.6 - 6.6 = 50 \text{ cm}$$

Calculation of pipe length L1:

Pipe length $L1 = M1 - (\text{sum of the z dimension of}$

tee piece no. 130 - 1 1/2 x 3/4 x 1 1/4 and bend no. 51 - 1 1/4)

z dimension tee no. 130 (on 1 1/4 exit) = 17 mm = 1.7 cm

z dimension bend = 33 mm = 3.3 cm

$$L1 = 127 - (1.7 + 3.3) = 127 - 5 = 122 \text{ cm}$$

Calculation of dimension M2:

$M2 = M - (M1 + b)$, $M1 = 127$, $b = 49$

$$M2 = 381 - (127 + 49) = 381 - 176 = 205 \text{ cm}$$

Calculation of pipe length L2:

Pipe length $L2 = M2 - (\text{sum of the z dimensions of}$

bend no. 51 - 1 1/4 and tee piece no. 130 - 1 1/4 x 3/4 x 1)

z dimension bend = 33 mm = 3.3 cm

z dimension tee no. 130 (on the 1 1/4 exit) = 17 mm = 1.7 cm

$$L2 = 205 - (3.3 + 1.7) = 205 - 5 = 200 \text{ cm}$$

Table to calculate the lengths of sloping pipes (examples see page 86)

α	88.5°			87°			85°			80°			75°			70°			60°			45°			30°			15°			α		
	β	b	c	b	c	b	c	b	c	b	c	b	c	b	c	b	c	b	c	b	c	b	c	b	c	b	c	b	c	a			
1	0,0	1,0	1,0	0,1	1,0	1,0	1,0	0,3	1,0	0,4	1,1	0,6	1,2	1	1,4	1,7	2	3,7	3,9	1													
2	0,1	2,0	2,0	0,2	2,0	0,4	2,0	0,5	2,1	0,7	2,1	1,2	2,3	2	2,8	3,5	4	7,5	7,7	2													
3	0,1	3,0	3,0	0,3	3,0	0,5	3,0	0,8	3,1	1,1	3,2	1,7	3,5	3	4,2	5,2	6	11,2	11,6	3													
4	0,1	4,0	4,0	0,3	4,0	0,7	4,1	1,1	4,1	1,5	4,3	2,3	4,6	4	5,7	6,9	8	14,9	15,5	4													
5	0,1	5,0	5,0	0,4	5,0	0,9	5,1	1,3	5,2	1,8	5,3	2,9	5,8	5	7,1	8,7	10	18,7	19,3	5													
6	0,2	6,0	6,0	0,5	6,0	1,1	6,1	1,6	6,2	2,2	6,4	3,5	6,9	6	8,5	10,4	12	22,4	23,2	6													
7	0,2	7,0	7,0	0,6	7,0	1,2	7,1	1,9	7,2	2,5	7,4	4,0	8,1	7	9,9	12,1	14	26,1	27,0	7													
8	0,2	8,0	8,0	0,7	8,0	1,4	8,1	2,1	8,3	2,9	8,5	4,6	9,2	8	11,3	13,9	16	29,9	30,9	8													
9	0,2	9,0	9,0	0,8	9,0	1,6	9,1	2,4	9,3	3,3	9,6	5,2	10,4	9	12,7	15,6	18	33,6	34,8	9													
10	0,3	10,0	10,0	0,9	10,0	1,8	10,2	2,7	10,4	3,6	10,6	5,8	11,5	10	14,1	17,3	20	37,3	38,6	10													
20	0,5	20,0	20,0	1,7	20,1	3,5	20,3	5,4	20,7	7,3	21,3	11,5	23,1	20	28,3	34,6	40	74,6	77,3	20													
30	0,8	30,0	30,0	2,6	30,1	5,3	30,5	8,0	31,1	10,9	31,9	17,3	34,6	30	42,4	52,0	60	112,0	115,9	30													
40	1,0	40,0	40,0	3,5	40,2	7,1	40,6	10,7	41,4	14,6	42,6	23,1	46,2	40	56,6	69,3	80	149,3	154,5	40													
50	1,3	50,0	50,0	4,4	50,2	8,8	50,8	13,4	51,8	18,2	53,2	28,9	57,7	50	70,7	86,6	100	186,6	193,2	50													
60	1,6	60,0	60,0	5,2	60,2	10,6	60,9	16,1	62,1	21,8	63,9	34,6	69,3	60	84,9	103,9	120	223,9	231,8	60													
70	1,8	70,0	70,0	6,1	70,3	12,3	71,1	18,8	72,5	25,5	74,5	40,4	80,8	70	99,0	121,2	140	261,2	270,5	70													
80	2,1	80,0	80,0	7,0	80,3	14,1	81,2	21,4	83,8	29,1	85,1	46,2	92,4	80	113,1	138,6	160	298,6	309,1	80													
90	2,4	90,0	90,0	7,9	90,3	15,9	91,4	24,1	92,2	32,8	95,8	52,0	103,9	90	127,3	155,9	180	335,9	347,7	90													
100	2,6	100,0	100,0	8,7	100,4	17,6	101,5	26,8	103,5	36,4	106,4	57,7	115,5	100	141,4	173,2	200	373,2	386,4	100													
200	5,2	200,1	200,3	17,5	200,8	35,3	203,1	53,6	207,1	72,8	212,8	115,5	230,9	200	282,8	346,4	400	746,4	772,7	200													
300	7,9	300,1	300,4	26,2	301,1	52,9	304,6	80,4	310,6	109,2	319,3	173,2	346,4	300	424,3	519,6	600	1.119,6	1.159,1	300													
400	10,5	400,1	400,5	35,0	401,5	70,5	406,2	107,2	414,1	145,6	425,7	230,9	461,9	400	565,7	692,8	800	1.492,8	1.545,5	400													
500	13,1	500,2	500,7	43,7	501,9	88,2	507,7	134,0	517,6	182,0	532,1	288,7	577,4	500	707,1	886,0	1.000	1.866,0	1.931,9	500													
600	15,7	600,2	600,8	52,5	602,3	105,8	609,3	160,8	621,2	218,4	638,5	346,4	692,8	600	848,5	1.039,2	1.200	2.239,2	2.318,2	600													
700	18,3	700,2	701,0	61,2	702,7	123,4	710,8	187,6	724,7	254,8	744,9	404,1	808,3	700	989,9	1.212,4	1.400	2.612,4	2.704,6	700													
800	21,0	800,3	801,1	70,0	803,1	141,1	812,3	214,4	825,2	291,2	851,3	461,9	923,8	800	1.131,4	1.385,6	1.600	2.985,6	3.091,0	800													
900	23,6	900,3	901,2	78,7	903,4	158,7	913,9	241,2	931,8	327,6	957,8	519,6	1.039,2	900	1.272,8	1.558,8	1.800	3.358,8	3.477,3	900													
1.000	26,2	1.000,3	1.001,4	87,5	1.003,8	176,3	1.015,4	267,9	1.035,3	364,0	1.064,2	577,4	1.154,7	1.000	1.414,2	1.732,1	2.000	3.732,1	3.863,7	1.000													

Example: the b and c belonging to a = 283 are the product of the b and c for 3.80 and 200

3	0,1	3,0	0,2	3,0	0,3	3,0	0,5	3,0	0,8	3,1	1,1	3,2	1,7	3,5	4,2	5,2	6	11,2	11,6	3
80	2,1	80,0	4,2	80,1	7,0	80,3	14,1	81,2	21,4	82,8	29,1	85,1	46,2	92,4	113,1	138,6	160	298,6	309,1	80
200	5,2	200,1	10,5	200,3	17,5	200,8	35,3	203,1	53,6	207,1	72,8	212,8	115,5	230,9	282,8	346,4	400	746,4	772,7	200
283	7,4	283,1	14,9	283,4	24,8	284,1	49,9	287,3	75,8	293,0	103,0	301,1	163,4	326,8	400,1	490,2	566,0	1.056,2	1.093,4	283

b and c for every other three figure number can be calculated in the same way.

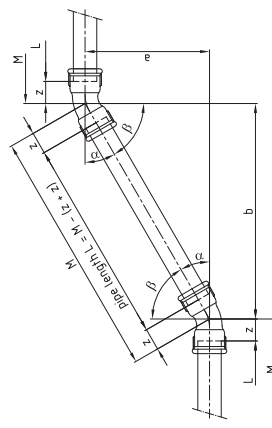

α = given angle
 β = accompanying angle
 a = given dimension
 in the following boxes = the sought values b and c belonging to a , α and β

Fittings combinations

15°
53/54



30°
50/51

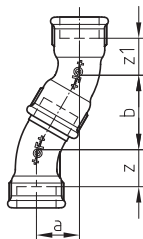

45°
40/41

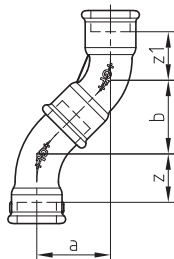

45°
120/121

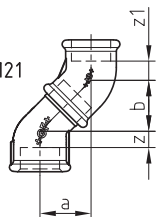

90°
1/2

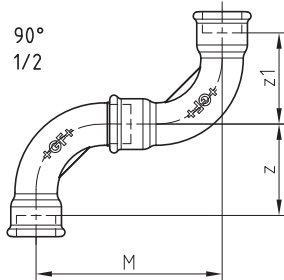

90°
1A/2A

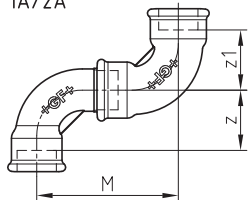

90°
90/92

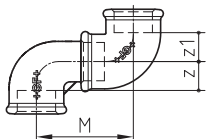

		15°	30°	45°			90°		
		53/54	50/51	40/41	120/121		1/2	1a/2a	90/92
3/8	a			31	25	M z = z1	80 38	62 26	47 15
	b			31	25				
	z			20	10				
	z1			20	10				
1/2	a	9	21	37	26	M z = z1	90 42	77 32	52 15
	b	35	36	37	26				
	z	15	17	23	9				
	z1	15	17	23	9				
3/4	a	11	26	45	30	M z = z1	114 54	85 35	61 18
	b	42	44	45	30				
	z	18	21	28	10				
	z1	18	21	28	10				
1	a	13	32	54	34	M z = z1	143 68	109 46	73 21
	b	47	55	54	34				
	z	20	27	34	11				
	z1	20	27	34	11				
1 1/4	a	16	39	70	40	M z = z1	181 86	133 57	86 26
	b	58	67	70	40				
	z	24	33	45	14				
	z1	26	33	45	14				
1 1/2	a	16	42	76	45	M z = z1	202 97	151 66	96 31
	b	61	72	76	45				
	z	26	37	49	17				
	z1	28	37	49	17				
2	a	18	48	90	52	M z = z1	246 116	180 78	108 34
	b	66	83	90	52				
	z	27	42	57	19				
	z1	27	42	57	19				
2 1/2	a			112	53	M z = z1	314 149	203 88	130 42
	b			112	53				
	z			72	19				
	z1			72	21				
3	a			129	60	M z = z1	365 175	224 97	146 48
	b			129	60				
	z			83	22				
	z1			83	24				
4	a			166		M z = z1	469 224	294 129	178 60
	b			166					
	z			105					
	z1			105					

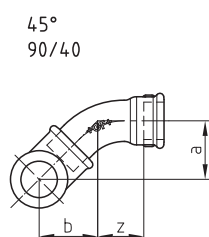
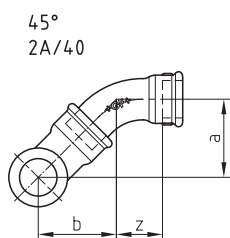
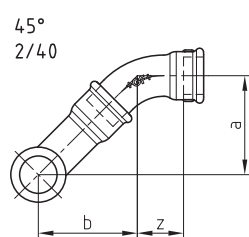
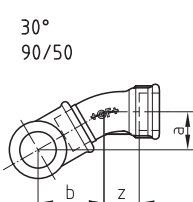
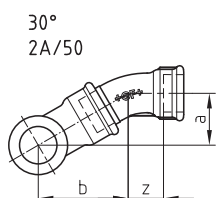
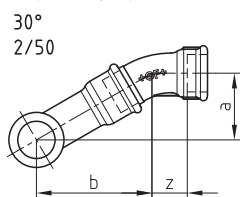
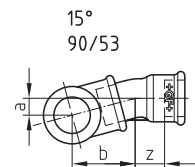
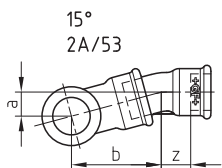
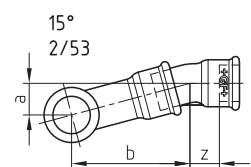

		15°			30°			45°		
		2/53	2a/53	90/53	2/50	2a/50	90/50	2/40	2a/40	90/40
3/8	a							44	35	28
	b							44	35	28
	z							20	20	20
1/2	a	16	14	9	33	28	20	51	44	32
	b	61	51	35	57	48	35	51	44	32
	z	15	15	15	17	17	17	23	23	23
3/4	a	20	15	11	42	33	24	64	50	38
	b	76	58	42	73	56	42	64	50	38
	z	18	18	18	21	21	21	28	28	28
1	a	25	19	13	52	41	29	78	62	45
	b	94	72	48	90	71	49	78	62	45
	z	20	20	20	27	27	27	34	34	34
1 1/4	a	31	24	16	65	51	35	99	78	57
	b	116	88	58	113	87	61	99	78	57
	z	24	24	24	33	33	33	45	45	45
1 1/2	a	34	26	17	72	56	39	110	88	63
	b	128	98	64	124	97	67	110	88	63
	z	26	26	26	37	37	37	49	49	49
2	a	41	31	19	85	66	44	132	105	74
	b	152	115	72	147	114	76	132	105	74
	z	27	27	27	42	42	42	57	57	57
2 1/2	a	52	36	24	108	77	54	166	123	91
	b	194	135	91	186	133	94	166	123	91
	z	35	35	35	53	53	53	72	72	72
3	a				126	87	63	194	139	105
	b				218	151	108	194	139	105
	z				62	62	62	83	83	83
4	a				162	115	80	250	183	134
	b				281	198	139	250	183	134
	z				78	78	78	105	105	105

45°
130/40

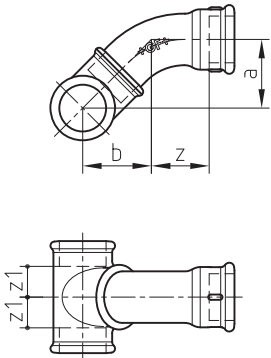

Equal run		Branch									
		3/8	1/2	3/4	1	1 1/4	1 1/2	2	2 1/2	3	4
3/8	a=b	28									
	z1	15									
	z	20									
1/2	a=b	28	32								
	z1	13	15								
	z	20	23								
3/4	a=b	30	34	38							
	z1	13	15	18							
	z	20	23	28							
1	a=b	33	36	40	45						
	z1	13	15	18	21						
	z	20	23	28	34						
1 1/4	a=b	35	39	44	47	57					
	z1	13	15	17	21	26					
	z	20	23	28	34	45					
1 1/2	a=b	37	42	46	50	59	63				
	z1	14	17	19	23	27	31				
	z	20	23	28	34	45	49				
2	a=b		46	50	54	63	66	74			
	z1		14	16	20	24	28	34			
	z		23	28	34	45	49	57			
2 1/2	a=b		52	57	60	69	72	79	91		
	z1		14	18	20	25	28	34	42		
	z		23	28	34	45	49	57	72		
3	a=b		57	62	65	74	78	84	95	105	
	z1		15	18	21	25	28	34	42	48	
	z		23	28	34	45	49	57	72	93	
4	a=b				74		87	93	105	115	134
	z1				20		28	34	41	48	60
	z				34		49	57	72	93	105

90°
130/1

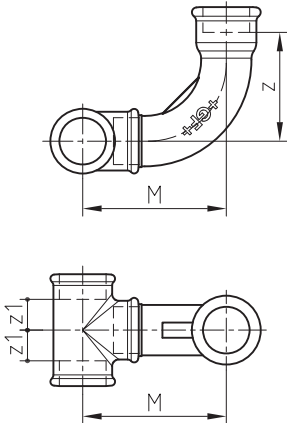

Equal run		Branch									
		3/8	1/2	3/4	1	1 1/4	1 1/2	2	2 1/2	3	4
3/8	M	57									
	z1	15									
	z	38									
1/2	M	58	63								
	z1	13	15								
	z	38	42								
3/4	M	60	66	78							
	z1	13	15	18							
	z	38	42	54							
1	M	64	69	81	96						
	z1	13	15	18	21						
	z	38	42	54	68						
1 1/4	M	68	73	86	100	121					
	z1	13	15	17	21	26					
	z	38	42	54	68	86					
1 1/2	M	70	77	89	104	124	136				
	z1	14	17	19	23	27	31				
	z	38	42	54	68	86	97				
2	M		83	95	110	130	141	164			
	z1		14	16	20	24	28	34			
	z		42	54	68	86	97	116			
2 1/2	M		91	104	118	138	149	172	207		
	z1		14	18	20	25	28	34	42		
	z		42	54	68	86	97	116	149		
3	M		98	111	125	146	157	179	214	238	
	z1		15	18	21	25	28	34	42	48	
	z		42	54	68	86	97	116	149	175	
4	M				138		170	192	227	252	305
	z1				20		28	34	41	48	60
	z				68		97	116	149	175	224

90°
130/1A

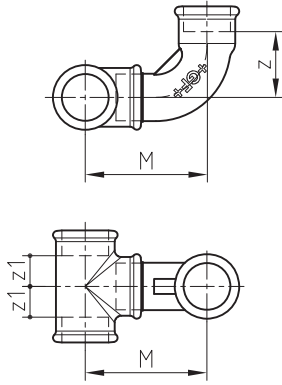

Equal run		Branch									
		3/8	1/2	3/4	1	1 1/4	1 1/2	2	2 1/2	3	4
3/8	M	51									
	z1	15									
	z	26									
1/2	M	52	60								
	z1	13	15								
	z	26	32								
3/4	M	54	63	68							
	z1	13	15	18							
	z	26	32	35							
1	M	58	66	71	84						
	z1	13	15	18	21						
	z	26	32	35	46						
1 1/4	M	62	70	76	88	102					
	z1	13	15	17	21	26					
	z	26	32	35	46	57					
1 1/2	M	64	74	79	92	105	116				
	z1	14	17	19	23	27	31				
	z	26	32	35	46	57	49				
2	M		80	85	98	111	121	136			
	z1		14	16	20	24	28	34			
	z		32	35	46	57	49	78			
2 1/2	M		88	94	106	119	129	144	157		
	z1		14	18	20	25	28	34	42		
	z		32	35	46	57	49	78	88		
3	M		95	101	113	127	137	151	164	175	
	z1		15	18	21	25	28	34	42	48	
	z		32	35	46	57	49	78	88	97	
4	M				126		150	164	177	189	225
	z1				20		28	34	41	48	60
	z				46		49	78	88	97	129



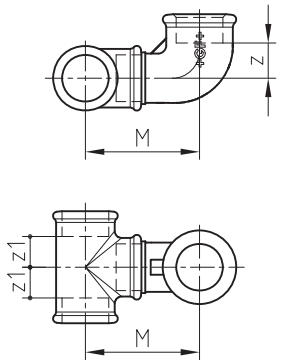















90°
130/92



Equal run		Branch									
		3/8	1/2	3/4	1	1 1/4	1 1/2	2	2 1/2	3	4
3/8	M	47									
	z1	15									
	z	15									
1/2	M	48	52								
	z1	13	15								
	z	15	15								
3/4	M	50	55	61							
	z1	13	15	18							
	z	15	15	18							
1	M	54	58	64	73						
	z1	13	15	18	21						
	z	15	15	18	21						
1 1/4	M	58	62	69	77	86					
	z1	13	15	17	21	26					
	z	15	15	18	21	26					
1 1/2	M	60	66	72	81	89	96				
	z1	14	17	19	23	27	31				
	z	15	15	18	21	26	31				
2	M		72	78	87	95	101	108			
	z1		14	16	20	24	28	34			
	z		15	18	21	26	31	34			
2 1/2	M		80	87	95	103	109	116	130		
	z1		14	18	20	25	28	34	42		
	z		15	18	21	26	31	34	42		
3	M		87	94	102	111	117	123	137	146	
	z1		15	18	21	25	28	34	42	48	
	z		15	18	21	26	31	34	42	48	
4	M				115		130	136	150	160	178
	z1				20		28	34	41	48	60
	z				21		31	34	42	48	60

Assembly assistance

z dimensions and face-centre dimensions of the most common Georg Fischer malleable cast iron fittings

Dimension		3/8		1/2		3/4		1		1 1/4		1 1/2		2		2 1/2		3		4	
Nominal thread length		10		13		15		17		19		19		24		27		30		36	
Catalogue No.		z	b	z	b	z	b	z	b	z	b	z	b	z	b	z	b	z	b	z	b
	1	38	42	42	48	54	60	68	75	86	95	97	105	116	130	149	165	175	190	224	245
	2	38	-	42	-	54	-	68	-	86	-	97	-	116	-	149	-	175	-	224	-
	1a	26	36	32	45	35	50	46	63	57	76	66	85	78	102	88	115	97	127	129	165
	2a	26	-	32	-	35	-	46	-	57	-	66	-	78	-	88	-	97	-	129	-
	45° 40	20	24	23	30	28	36	34	42	45	54	49	58	57	70	72	86	83	100	105	130
	45° 41	20	-	23	-	28	-	34	-	45	-	49	-	57	-	72	-	83	-	105	-
	30° 50	-	-	17	24	21	30	27	36	33	44	37	46	42	54	53	66	62	77	78	100
	30° 51	-	-	17	-	21	-	27	-	33	-	37	-	42	-	-	-	-	-	-	-
	85	28	-	34	-	40	-	53	-	66	-	-	-	-	-	-	-	-	-	-	-
	90	15	-	15	-	18	-	21	-	26	-	31	-	34	-	42	-	48	-	60	-
	92	15	32	15	37	18	43	21	52	26	60	31	65	34	74	42	88	48	98	60	118
	45° 120	10	-	9	-	10	-	11	-	14	-	17	-	19	-	21	-	24	-	-	-
	45° 121	10	25	9	28	10	32	11	37	14	43	17	46	19	55	19	54	22	61	-	-
	130	15	-	15	-	18	-	21	-	26	-	31	-	34	-	42	-	48	-	60	-
	180	15	-	15	-	18	-	21	-	26	-	31	-	34	-	42	-	48	-	60	-
	270	10	-	10	-	9	-	11	-	12	-	17	-	17	-	20	-	20	-	22	-
	471	15	-	15	-	18	-	-	-	-	-	-	-	-	-	-	-	-	-	-	-
		a		a		a		a		a		a		a		a		a		a	
	280	38		44		47		53		57		59		68		75		83		95	

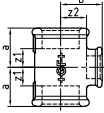
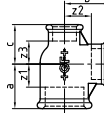
130, Branch reduced	Dimension	z1	z2	130, Branch and run reduced	Dimension	z1	z2	z3	Dimension	z1	z2	z3
		1/2 - 3/4	18		15		3/4 - 1/2 - 1/2	15	18	15	1 1/4 - 1 1/4 - 1	26
	3/4 - 1/2	15	18		3/4 - 3/4 - 1/2	18	18	18	1 1/2 - 3/4 - 1 1/4	19	29	17
	1 - 1/2	15	21		1 - 1/2 - 3/4	15	21	18	1 1/2 - 1 - 1 1/4	23	29	21
	1 - 3/4	18	21		1 - 3/4 - 3/4	18	21	15	1 1/2 - 1 1/4 - 1	27	29	25
	1 1/4 - 1/2	15	25		1 - 3/4 - 1/2	18	21	18	1 1/2 - 1 1/4 - 1 1/4	27	29	26
	1 1/4 - 3/4	17	26		1 - 1 - 3/4	21	21	21	1 1/2 - 1 1/2 - 1 1/4	31	31	29
	1 1/4 - 1	21	25		1 1/4 - 1/2 - 1	15	25	15	a ... dimension face - face (overall length)			
	1 1/2 - 1/2	17	29		1 1/4 - 3/4 - 1	17	26	18				
	1 1/2 - 3/4	19	29		1 1/4 - 1 - 3/4	21	25	21	b ... dimension fitting axis - face external thread			
	1 1/2 - 1	23	29		1 1/4 - 1 - 1	21	25	21				
	1 1/2 - 1 1/4	27	29		1 1/4 - 1 1/4 - 3/4	26	26	26	z, z1, z2, z3 ... z dimension			

Practical conclusions

The Georg Fischer z dimension installation method is the tried and tested basis for the skilled worker and industrial prefabrication of pipework installations.

Its objective is to bring together the same repetitive production sequences to achieve a trouble-free flow of materials and work, to avoid idle time, minimise setting up time and doing the same work twice and provide the optimal solutions.

This calls for:

- division of the pipework systems in installation sections.
- division of production in pre-assembly (in the workshop or on site) and installation. It is advantageous to prepare as large a number of the installations as possible in the workshop.
- summarised record of all important site dimensions, to be able to carry out in series prefabrication.

A main rule for this:

Gather as many pipework sections as possible from the planning documents.

However, where sections must be decided on the spot (offsetting of variations in the dimensions of the solidium) the following applies:

Always measure where pipelines are to be laid.

The Georg Fischer z dimension method enables:

- in series prefabrication
- rational use of material, skilled labour and machines
- reduction of installation times
- adaptability to building progress
- very large independence from building deadlines
- better preliminary conditions for carrying out non-local items
- better preliminary conditions for carrying out refurbishment work
- more accurate work with lower expenditure
- consistent quality

As a result of these advantages, installation planning, starting with the preliminary draft, should be included in the building plan. A prerequisite of the rational running of building work is completed, co-ordinated planning of the implementation of work at its outset in its basic details.

Caution: pre-assembled pipework combinations must never be so unwieldy that they can not be transported or used on the installation site without problems.

Note: using the z dimension method is not synonymous with prefabrication; it is in principle suitable for use anywhere that pipes are installed with fittings.

z dimension method for different materials

The above text refers primarily to the installation of threaded pipes with malleable cast iron pipe fittings. The transportational stability of assembled sections of pipework and the later possibilities of correcting their running directions on the site of installation make this materials system suitable for prefabrication.

Bearing the features of other materials systems (e.g. copper pipes with soldered fittings, plastic pipes with clamped, welded or bonded fittings) the Georg Fischer z dimension method can be used in the same way.

Pipe layout chart for z dimension method

Site:



Page No.

No. of pages

Date

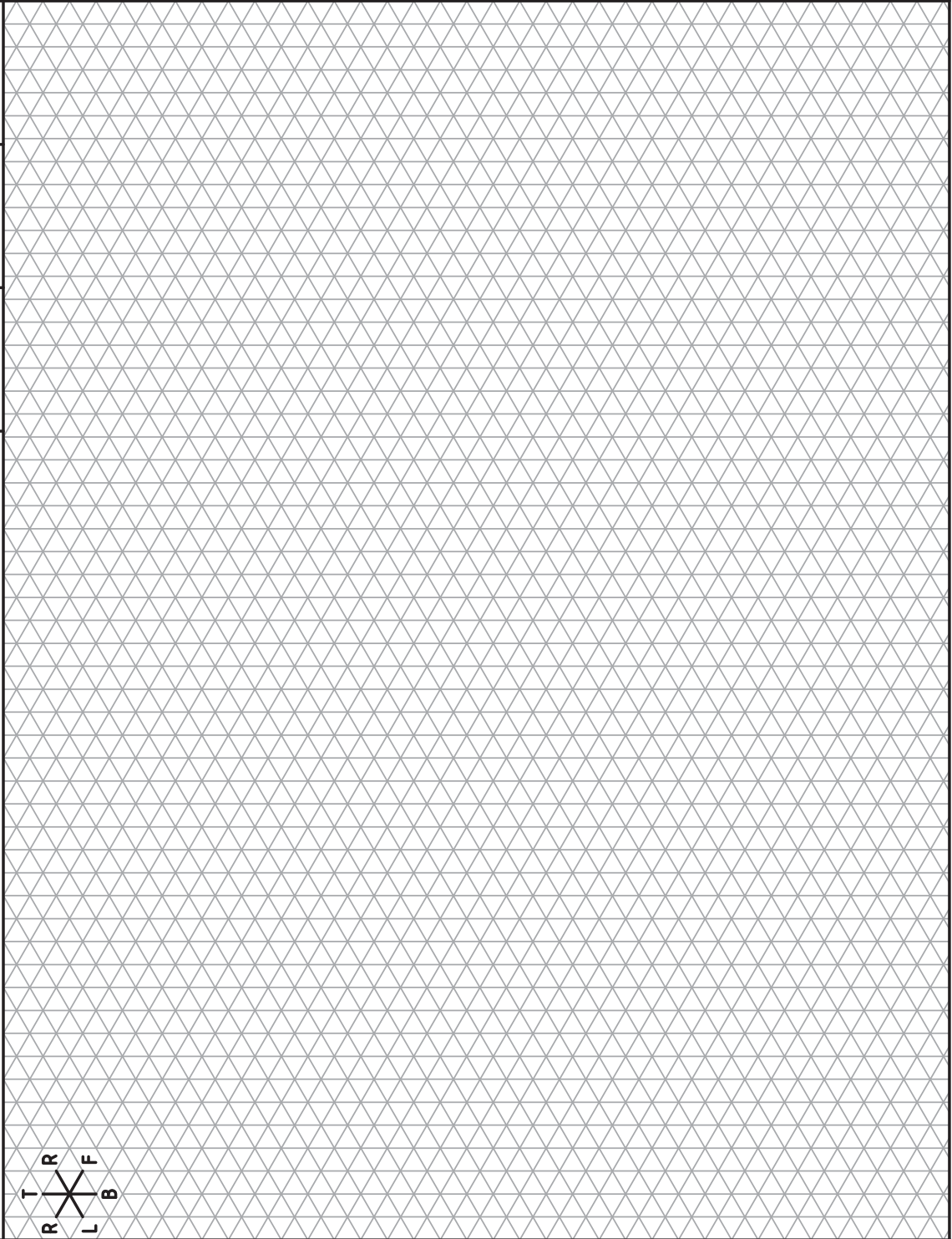

item

dimension M-M
in cm

Z dimensions
in cm

pipe length
in cm

inch dimension

Index

Code	Page	Code	Page	Code	Page
770 001 101	8	770 011 107	8	770 041 110	11
770 001 102	8	770 011 108	8	770 041 111	11
770 001 103	8	770 011 109	8	770 041 203	11
770 001 104	8	770 011 110	8	770 041 204	11
770 001 105	8	770 011 111	8	770 041 205	11
770 001 106	8	770 011 112	8	770 041 206	11
770 001 107	8	770 011 202	8	770 041 207	11
770 001 108	8	770 011 203	8	770 041 208	11
770 001 109	8	770 011 204	8	770 041 209	11
770 001 110	8	770 011 205	8	770 041 210	11
770 001 111	8	770 011 206	8	770 041 211	11
770 001 112	8	770 011 207	8	770 041 212	11
770 001 201	8	770 011 208	8	770 050 204	11
770 001 202	8	770 011 209	8	770 050 205	11
770 001 203	8	770 011 210	8	770 050 206	11
770 001 204	8	770 011 211	8	770 050 207	11
770 001 205	8	770 011 212	8	770 050 208	11
770 001 206	8	770 012 102	9	770 050 209	11
770 001 207	8	770 012 103	9	770 050 210	11
770 001 208	8	770 012 104	9	770 050 211	11
770 001 209	8	770 012 105	9	770 050 212	11
770 001 210	8	770 012 106	9	770 051 204	12
770 001 211	8	770 012 107	9	770 051 205	12
770 001 212	8	770 012 108	9	770 051 206	12
770 002 102	9	770 012 109	9	770 051 207	12
770 002 103	9	770 012 110	9	770 051 208	12
770 002 104	9	770 012 111	9	770 051 209	12
770 002 105	9	770 012 112	9	770 053 204	12
770 002 106	9	770 012 202	9	770 053 205	12
770 002 107	9	770 012 203	9	770 053 206	12
770 002 108	9	770 012 204	9	770 053 207	12
770 002 109	9	770 012 205	9	770 053 208	12
770 002 110	9	770 012 206	9	770 053 209	12
770 002 111	9	770 012 207	9	770 053 210	12
770 002 112	9	770 012 208	9	770 054 204	12
770 002 202	9	770 012 209	9	770 054 205	12
770 002 203	9	770 012 210	9	770 054 206	12
770 002 204	9	770 012 211	9	770 054 207	12
770 002 205	9	770 012 212	9	770 054 208	12
770 002 206	9	770 040 102	10	770 054 209	12
770 002 207	9	770 040 103	10	770 060 104	13
770 002 208	9	770 040 104	10	770 060 105	13
770 002 209	9	770 040 105	10	770 060 106	13
770 002 210	9	770 040 106	10	770 060 107	13
770 002 211	9	770 040 107	10	770 060 108	13
770 002 212	9	770 040 108	10	770 060 109	13
770 003 102	10	770 040 109	10	770 060 204	13
770 003 103	10	770 040 110	10	770 060 205	13
770 003 104	10	770 040 111	10	770 060 206	13
770 003 105	10	770 040 112	10	770 060 207	13
770 003 106	10	770 040 202	10	770 060 208	13
770 003 107	10	770 040 203	10	770 060 209	13
770 003 108	10	770 040 204	10	770 085 103	13
770 003 109	10	770 040 205	10	770 085 104	13
770 003 202	10	770 040 206	10	770 085 105	13
770 003 203	10	770 040 207	10	770 085 106	13
770 003 204	10	770 040 208	10	770 085 107	13
770 003 205	10	770 040 209	10	770 085 115	13
770 003 206	10	770 040 210	10	770 085 203	13
770 003 207	10	770 040 211	10	770 085 204	13
770 003 208	10	770 040 212	10	770 085 205	13
770 003 209	10	770 041 103	11	770 085 206	13
770 003 210	10	770 041 104	11	770 085 207	13
770 011 102	8	770 041 105	11	770 085 215	13
770 011 103	8	770 041 106	11	770 087 204	13
770 011 104	8	770 041 107	11	770 090 101	14
770 011 105	8	770 041 108	11	770 090 102	14
770 011 106	8	770 041 109	11	770 090 103	14

Index

Code	Page	Code	Page	Code	Page
770 090 104	14	770 092 116	16	770 096 107	18
770 090 105	14	770 092 117	16	770 096 108	18
770 090 106	14	770 092 118	16	770 096 109	18
770 090 107	14	770 092 120	16	770 096 110	18
770 090 108	14	770 092 121	16	770 096 111	18
770 090 109	14	770 092 122	16	770 096 202	18
770 090 110	14	770 092 124	17	770 096 203	18
770 090 111	14	770 092 125	17	770 096 204	18
770 090 112	14	770 092 126	17	770 096 205	18
770 090 115	15	770 092 127	17	770 096 206	18
770 090 116	15	770 092 130	16	770 096 207	18
770 090 117	15	770 092 201	16	770 096 208	18
770 090 118	15	770 092 202	16	770 096 209	18
770 090 120	15	770 092 203	16	770 096 210	18
770 090 121	15	770 092 204	16	770 096 211	18
770 090 122	15	770 092 205	16	770 097 103	19
770 090 123	15	770 092 206	16	770 097 104	19
770 090 124	15	770 092 207	16	770 097 105	19
770 090 125	15	770 092 208	16	770 097 106	19
770 090 126	15	770 092 209	16	770 097 107	19
770 090 127	15	770 092 210	16	770 097 108	19
770 090 128	15	770 092 211	16	770 097 109	19
770 090 129	15	770 092 212	16	770 097 203	19
770 090 130	15	770 092 216	16	770 097 204	19
770 090 132	15	770 092 217	16	770 097 205	19
770 090 145	15	770 092 218	16	770 097 206	19
770 090 201	14	770 092 219	16	770 097 207	19
770 090 202	14	770 092 220	16	770 097 208	19
770 090 203	14	770 092 221	16	770 097 209	19
770 090 204	14	770 092 222	16	770 098 102	20
770 090 205	14	770 092 224	17	770 098 103	20
770 090 206	14	770 092 225	17	770 098 104	20
770 090 207	14	770 092 226	17	770 098 105	20
770 090 208	14	770 092 227	17	770 098 106	20
770 090 209	14	770 092 230	16	770 098 107	20
770 090 210	14	770 094 103	17	770 098 108	20
770 090 211	14	770 094 104	17	770 098 109	20
770 090 212	14	770 094 105	17	770 098 110	20
770 090 215	15	770 094 106	17	770 098 111	20
770 090 216	15	770 094 107	17	770 098 202	20
770 090 217	15	770 094 108	17	770 098 203	20
770 090 218	15	770 094 109	17	770 098 204	20
770 090 220	15	770 094 203	17	770 098 205	20
770 090 221	15	770 094 204	17	770 098 206	20
770 090 222	15	770 094 205	17	770 098 207	20
770 090 223	15	770 094 206	17	770 098 208	20
770 090 224	15	770 094 207	17	770 098 209	20
770 090 225	15	770 094 208	17	770 098 210	20
770 090 226	15	770 094 209	17	770 098 211	20
770 090 227	15	770 095 103	17	770 100 104	20
770 090 228	15	770 095 104	17	770 100 105	20
770 090 229	15	770 095 105	17	770 100 106	20
770 090 230	15	770 095 106	17	770 100 204	20
770 090 231	15	770 095 107	17	770 100 205	20
770 090 232	15	770 095 108	17	770 100 206	20
770 090 245	15	770 095 109	17	770 101 104	21
770 092 101	16	770 095 203	17	770 101 105	21
770 092 102	16	770 095 204	17	770 101 106	21
770 092 103	16	770 095 205	17	770 101 204	21
770 092 104	16	770 095 206	17	770 101 205	21
770 092 105	16	770 095 207	17	770 101 206	21
770 092 106	16	770 095 208	17	770 102 104	21
770 092 107	16	770 095 209	17	770 102 105	21
770 092 108	16	770 096 102	18	770 102 106	21
770 092 109	16	770 096 103	18	770 102 204	21
770 092 110	16	770 096 104	18	770 102 205	21
770 092 111	16	770 096 105	18	770 102 206	21
770 092 112	16	770 096 106	18	770 103 104	22

Index

Code	Page
770 103 105	22
770 103 106	22
770 103 204	22
770 103 205	22
770 103 206	22
770 120 103	22
770 120 104	22
770 120 105	22
770 120 106	22
770 120 107	22
770 120 108	22
770 120 109	22
770 120 110	22
770 120 111	22
770 120 203	22
770 120 204	22
770 120 205	22
770 120 206	22
770 120 207	22
770 120 208	22
770 120 209	22
770 120 210	22
770 120 211	22
770 121 103	23
770 121 104	23
770 121 105	23
770 121 106	23
770 121 107	23
770 121 108	23
770 121 109	23
770 121 110	23
770 121 111	23
770 121 203	23
770 121 204	23
770 121 205	23
770 121 206	23
770 121 207	23
770 121 208	23
770 121 209	23
770 121 210	23
770 121 211	23
770 129 115	25
770 129 116	25
770 129 118	25
770 129 119	27
770 129 120	25
770 129 122	27
770 129 123	27
770 129 124	25
770 129 125	25
770 129 126	25
770 129 127	25
770 129 128	25
770 129 130	25
770 129 131	25
770 129 133	25
770 129 135	25
770 129 136	25
770 129 138	25
770 129 215	25
770 129 216	25
770 129 218	25
770 129 219	27
770 129 220	25
770 129 221	27
770 129 222	27
770 129 223	27
770 129 224	25

Code	Page
770 129 225	25
770 129 226	25
770 129 227	25
770 129 228	25
770 129 229	27
770 129 230	25
770 129 231	25
770 129 232	27
770 129 233	25
770 129 235	25
770 129 236	25
770 129 237	25
770 129 238	25
770 130 101	23
770 130 102	23
770 130 103	23
770 130 104	23
770 130 105	23
770 130 106	23
770 130 107	23
770 130 108	23
770 130 109	23
770 130 110	23
770 130 111	23
770 130 112	23
770 130 115	24
770 130 116	24
770 130 117	24
770 130 118	26
770 130 119	24
770 130 120	26
770 130 121	24
770 130 122	24
770 130 123	26
770 130 124	24
770 130 125	26
770 130 126	26
770 130 127	24
770 130 128	26
770 130 129	26
770 130 130	24
770 130 131	26
770 130 132	24
770 130 133	24
770 130 134	24
770 130 135	26
770 130 136	26
770 130 137	24
770 130 138	26
770 130 139	26
770 130 140	24
770 130 141	26
770 130 142	26
770 130 143	26
770 130 144	26
770 130 145	24
770 130 146	24
770 130 147	26
770 130 148	24
770 130 149	26
770 130 150	26
770 130 151	24
770 130 153	26
770 130 154	26
770 130 155	24
770 130 156	26
770 130 157	26
770 130 158	26

Code	Page
770 130 159	24
770 130 160	26
770 130 161	24
770 130 162	24
770 130 163	26
770 130 164	24
770 130 165	26
770 130 166	24
770 130 167	26
770 130 168	26
770 130 169	24
770 130 170	26
770 130 171	26
770 130 172	24
770 130 173	26
770 130 174	27
770 130 175	27
770 130 176	27
770 130 177	24
770 130 178	27
770 130 179	24
770 130 180	27
770 130 181	24
770 130 182	27
770 130 183	24
770 130 184	27
770 130 185	24
770 130 186	27
770 130 187	27
770 130 188	24
770 130 190	27
770 130 191	25
770 130 192	27
770 130 193	27
770 130 194	27
770 130 195	27
770 130 196	27
770 130 197	25
770 130 198	25
770 130 199	25
770 130 201	23
770 130 202	23
770 130 203	23
770 130 204	23
770 130 205	23
770 130 206	23
770 130 207	23
770 130 208	23
770 130 209	23
770 130 210	23
770 130 211	23
770 130 212	23
770 130 215	24
770 130 216	24
770 130 217	24
770 130 218	26
770 130 219	24
770 130 220	26
770 130 221	24
770 130 222	24
770 130 223	26
770 130 224	24
770 130 225	26
770 130 226	26
770 130 227	24
770 130 228	26
770 130 229	26
770 130 230	24

Index

Code	Page	Code	Page	Code	Page
770 130 231	26	770 131 105	28	770 132 209	29
770 130 232	24	770 131 106	28	770 133 103	30
770 130 233	24	770 131 107	28	770 133 104	30
770 130 234	24	770 131 108	28	770 133 105	30
770 130 235	26	770 131 109	28	770 133 106	30
770 130 236	26	770 131 110	28	770 133 203	30
770 130 237	24	770 131 111	28	770 133 204	30
770 130 238	26	770 131 112	28	770 133 205	30
770 130 239	26	770 131 115	29	770 133 206	30
770 130 240	24	770 131 116	28	770 134 102	30
770 130 241	26	770 131 117	29	770 134 103	30
770 130 242	26	770 131 118	29	770 134 104	30
770 130 243	26	770 131 119	28	770 134 105	30
770 130 244	26	770 131 120	29	770 134 106	30
770 130 245	24	770 131 121	28	770 134 107	30
770 130 246	24	770 131 122	28	770 134 108	30
770 130 247	26	770 131 123	28	770 134 109	30
770 130 248	24	770 131 125	28	770 134 116	30
770 130 249	26	770 131 126	28	770 134 118	30
770 130 250	26	770 131 127	28	770 134 119	30
770 130 251	24	770 131 128	28	770 134 202	30
770 130 253	26	770 131 129	28	770 134 203	30
770 130 254	26	770 131 130	28	770 134 204	30
770 130 255	24	770 131 131	28	770 134 205	30
770 130 256	26	770 131 132	28	770 134 206	30
770 130 257	26	770 131 135	28	770 134 207	30
770 130 258	26	770 131 137	28	770 134 208	30
770 130 259	24	770 131 140	28	770 134 209	30
770 130 260	26	770 131 204	28	770 134 216	30
770 130 261	24	770 131 205	28	770 134 218	30
770 130 262	24	770 131 206	28	770 134 219	30
770 130 263	26	770 131 207	28	770 135 104	31
770 130 264	24	770 131 208	28	770 135 105	31
770 130 265	26	770 131 209	28	770 135 106	31
770 130 266	24	770 131 210	28	770 135 204	31
770 130 267	26	770 131 211	28	770 135 205	31
770 130 268	26	770 131 212	28	770 135 206	31
770 130 269	24	770 131 215	29	770 137 216	31
770 130 270	26	770 131 216	28	770 137 217	31
770 130 271	26	770 131 217	29	770 137 219	31
770 130 272	24	770 131 218	29	770 165 103	31
770 130 273	27	770 131 219	28	770 165 104	31
770 130 274	27	770 131 220	29	770 165 105	31
770 130 275	27	770 131 221	28	770 165 106	31
770 130 276	27	770 131 222	28	770 165 107	31
770 130 277	24	770 131 223	28	770 165 108	31
770 130 278	27	770 131 225	28	770 165 109	31
770 130 279	24	770 131 226	28	770 165 204	31
770 130 280	27	770 131 227	28	770 165 205	31
770 130 281	24	770 131 228	28	770 165 206	31
770 130 282	27	770 131 229	28	770 165 207	31
770 130 283	24	770 131 230	28	770 165 208	31
770 130 284	27	770 131 231	28	770 165 209	31
770 130 285	24	770 131 232	28	770 180 102	32
770 130 286	27	770 131 233	28	770 180 103	32
770 130 287	27	770 131 235	28	770 180 104	32
770 130 288	24	770 131 240	28	770 180 105	32
770 130 290	27	770 132 104	29	770 180 106	32
770 130 291	25	770 132 105	29	770 180 107	32
770 130 292	27	770 132 106	29	770 180 108	32
770 130 293	27	770 132 107	29	770 180 109	32
770 130 294	27	770 132 108	29	770 180 110	32
770 130 295	27	770 132 109	29	770 180 111	32
770 130 296	27	770 132 204	29	770 180 112	32
770 130 297	25	770 132 205	29	770 180 115	32
770 130 298	25	770 132 206	29	770 180 116	32
770 130 299	25	770 132 207	29	770 180 117	32
770 131 104	28	770 132 208	29	770 180 118	32

Index

Code	Page
770 180 120	32
770 180 121	32
770 180 202	32
770 180 203	32
770 180 204	32
770 180 205	32
770 180 206	32
770 180 207	32
770 180 208	32
770 180 209	32
770 180 210	32
770 180 211	32
770 180 212	32
770 180 215	32
770 180 216	32
770 180 217	32
770 180 218	32
770 180 220	32
770 180 221	32
770 220 103	33
770 220 104	33
770 220 105	33
770 220 106	33
770 220 203	33
770 220 204	33
770 220 205	33
770 220 206	33
770 221 103	33
770 221 104	33
770 221 105	33
770 221 106	33
770 221 107	33
770 221 108	33
770 221 109	33
770 221 203	33
770 221 204	33
770 221 205	33
770 221 206	33
770 221 207	33
770 221 208	33
770 221 209	33
770 223 104	33
770 223 105	33
770 223 106	33
770 223 204	33
770 223 205	33
770 223 206	33
770 240 115	34
770 240 116	34
770 240 117	34
770 240 118	34
770 240 119	34
770 240 120	34
770 240 121	34
770 240 122	34
770 240 123	34
770 240 124	34
770 240 125	34
770 240 126	34
770 240 127	34
770 240 128	34
770 240 129	34
770 240 130	34
770 240 131	34
770 240 132	34
770 240 133	34
770 240 134	34
770 240 133	34
770 240 134	34
770 240 135	34
770 240 134	34
770 240 135	34

Code	Page
770 240 136	34
770 240 137	34
770 240 138	34
770 240 139	34
770 240 141	34
770 240 142	34
770 240 143	34
770 240 144	34
770 240 145	34
770 240 146	35
770 240 147	35
770 240 148	35
770 240 215	34
770 240 216	34
770 240 217	34
770 240 218	34
770 240 219	34
770 240 220	34
770 240 221	34
770 240 222	34
770 240 223	34
770 240 224	34
770 240 225	34
770 240 226	34
770 240 227	34
770 240 228	34
770 240 229	34
770 240 230	34
770 240 231	34
770 240 232	34
770 240 233	34
770 240 234	34
770 240 235	34
770 240 236	34
770 240 237	34
770 240 238	34
770 240 239	34
770 240 241	34
770 240 242	34
770 240 243	34
770 240 244	34
770 240 245	34
770 240 246	35
770 240 247	35
770 240 248	35
770 241 115	36
770 241 116	36
770 241 117	36
770 241 118	36
770 241 119	36
770 241 120	36
770 241 121	36
770 241 122	36
770 241 123	36
770 241 124	36
770 241 125	36
770 241 126	36
770 241 127	36
770 241 128	36
770 241 129	36
770 241 130	36
770 241 131	36
770 241 132	36
770 241 133	36
770 241 134	36
770 241 135	36
770 241 136	36
770 241 137	36

Code	Page
770 241 138	36
770 241 139	36
770 241 140	36
770 241 141	36
770 241 142	36
770 241 143	36
770 241 144	36
770 241 145	37
770 241 146	37
770 241 147	37
770 241 148	37
770 241 149	37
770 241 150	37
770 241 151	37
770 241 152	37
770 241 153	37
770 241 215	36
770 241 216	36
770 241 217	36
770 241 218	36
770 241 219	36
770 241 220	36
770 241 221	36
770 241 222	36
770 241 223	36
770 241 224	36
770 241 225	36
770 241 226	36
770 241 227	36
770 241 228	36
770 241 229	36
770 241 230	36
770 241 231	36
770 241 232	36
770 241 233	36
770 241 234	36
770 241 235	36
770 241 236	36
770 241 237	36
770 241 238	36
770 241 239	36
770 241 240	36
770 241 241	36
770 241 242	36
770 241 243	36
770 241 244	37
770 241 245	37
770 241 246	37
770 241 247	37
770 241 248	37
770 241 249	37
770 241 250	37
770 241 251	37
770 241 252	37
770 241 253	37
770 245 115	38
770 245 116	38
770 245 117	38
770 245 118	38
770 245 119	38
770 245 120	38
770 245 121	38
770 245 122	38
770 245 123	38
770 245 124	38
770 245 125	38
770 245 126	38
770 245 127	38

Index

Code	Page
770 245 128	38
770 245 129	38
770 245 130	38
770 245 131	38
770 245 132	38
770 245 133	38
770 245 134	38
770 245 135	38
770 245 136	38
770 245 137	38
770 245 138	38
770 245 215	38
770 245 216	38
770 245 217	38
770 245 218	38
770 245 219	38
770 245 220	38
770 245 221	38
770 245 222	38
770 245 223	38
770 245 224	38
770 245 225	38
770 245 226	38
770 245 227	38
770 245 228	38
770 245 229	38
770 245 230	38
770 245 231	38
770 245 232	38
770 245 233	38
770 245 234	38
770 245 235	38
770 245 236	38
770 245 237	38
770 245 238	38
770 246 115	39
770 246 116	39
770 246 117	39
770 246 118	39
770 246 119	39
770 246 120	39
770 246 121	39
770 246 122	39
770 246 123	39
770 246 124	39
770 246 125	39
770 246 126	39
770 246 127	39
770 246 128	39
770 246 129	39
770 246 130	39
770 246 131	39
770 246 132	39
770 246 133	39
770 246 134	39
770 246 135	39
770 246 215	39
770 246 216	39
770 246 217	39
770 246 218	39
770 246 219	39
770 246 220	39
770 246 221	39
770 246 222	39
770 246 223	39
770 246 224	39
770 246 225	39
770 246 226	39

Code	Page
770 246 227	39
770 246 228	39
770 246 229	39
770 246 230	39
770 246 231	39
770 246 232	39
770 246 233	39
770 246 234	39
770 246 235	39
770 260 115	40
770 260 116	40
770 260 117	40
770 260 118	40
770 260 119	40
770 260 120	40
770 260 121	40
770 260 122	40
770 260 123	40
770 260 124	40
770 260 125	40
770 260 126	40
770 260 127	40
770 260 128	40
770 260 129	40
770 260 130	40
770 260 215	40
770 260 216	40
770 260 217	40
770 260 218	40
770 260 219	40
770 260 220	40
770 260 221	40
770 260 222	40
770 260 223	40
770 260 224	40
770 260 225	40
770 260 226	40
770 260 227	40
770 260 228	40
770 260 229	40
770 260 230	40
770 270 101	41
770 270 102	41
770 270 103	41
770 270 104	41
770 270 105	41
770 270 106	41
770 270 107	41
770 270 108	41
770 270 109	41
770 270 110	41
770 270 111	41
770 270 112	41
770 270 201	41
770 270 202	41
770 270 203	41
770 270 204	41
770 270 205	41
770 270 206	41
770 270 207	41
770 270 208	41
770 270 209	41
770 270 210	41
770 270 211	41
770 270 212	41
770 271 103	42
770 271 104	42
770 271 105	42

Code	Page
770 271 106	42
770 271 107	42
770 271 108	42
770 271 109	42
770 271 203	42
770 271 204	42
770 271 205	42
770 271 206	42
770 271 207	42
770 271 208	42
770 271 209	42
770 280 101	42
770 280 102	42
770 280 103	42
770 280 104	42
770 280 105	42
770 280 106	42
770 280 107	42
770 280 108	42
770 280 109	42
770 280 110	42
770 280 111	42
770 280 112	42
770 280 201	42
770 280 202	42
770 280 203	42
770 280 204	42
770 280 205	42
770 280 206	42
770 280 207	42
770 280 208	42
770 280 209	42
770 280 210	42
770 280 211	42
770 280 212	42
770 281 104	43
770 281 105	43
770 281 106	43
770 281 107	43
770 281 108	43
770 281 109	43
770 281 203	43
770 281 204	43
770 281 205	43
770 281 206	43
770 281 207	43
770 281 208	43
770 281 209	43
770 290 101	43
770 290 102	43
770 290 103	43
770 290 104	43
770 290 105	43
770 290 106	43
770 290 107	43
770 290 108	43
770 290 109	43
770 290 110	43
770 290 111	43
770 290 112	43
770 290 201	43
770 290 202	43
770 290 203	43
770 290 204	43
770 290 205	43
770 290 206	43
770 290 207	43
770 290 208	43

Index

Code	Page	Code	Page	Code	Page
770 290 209	43	770 300 207	45	770 320 204	47
770 290 210	43	770 300 208	45	770 320 205	47
770 290 211	43	770 300 209	45	770 320 206	47
770 290 212	43	770 300 210	45	770 320 207	47
770 291 101	44	770 300 211	45	770 320 208	47
770 291 102	44	770 300 212	45	770 320 209	47
770 291 103	44	770 308 204	46	770 326 104	47
770 291 104	44	770 308 205	46	770 326 105	47
770 291 105	44	770 308 206	46	770 326 106	47
770 291 106	44	770 308 207	46	770 326 107	47
770 291 107	44	770 308 208	46	770 326 108	47
770 291 108	44	770 308 209	46	770 326 109	47
770 291 109	44	770 309 104	46	770 326 204	47
770 291 110	44	770 309 105	46	770 326 205	47
770 291 111	44	770 309 106	46	770 326 206	47
770 291 112	44	770 309 107	46	770 326 207	47
770 291 201	44	770 309 108	46	770 326 208	47
770 291 202	44	770 309 109	46	770 326 209	47
770 291 203	44	770 309 204	46	770 329 104	48
770 291 204	44	770 309 205	46	770 329 105	48
770 291 205	44	770 309 206	46	770 329 106	48
770 291 206	44	770 309 207	46	770 329 107	48
770 291 207	44	770 309 208	46	770 329 108	48
770 291 208	44	770 309 209	46	770 329 109	48
770 291 209	44	770 310 101	46	770 329 110	48
770 291 210	44	770 310 102	46	770 329 111	48
770 291 211	44	770 310 103	46	770 329 112	48
770 291 212	44	770 310 104	46	770 329 115	48
770 292 105	44	770 310 105	46	770 329 204	48
770 292 106	44	770 310 106	46	770 329 205	48
770 292 107	44	770 310 107	46	770 329 206	48
770 292 108	44	770 310 108	46	770 329 207	48
770 292 109	44	770 310 109	46	770 329 208	48
770 292 205	44	770 310 110	46	770 329 209	48
770 292 206	44	770 310 111	46	770 329 210	48
770 292 207	44	770 310 201	46	770 329 211	48
770 292 208	44	770 310 202	46	770 329 212	48
770 292 209	44	770 310 203	46	770 329 215	48
770 294 104	45	770 310 204	46	770 330 102	48
770 294 105	45	770 310 205	46	770 330 103	48
770 294 106	45	770 310 206	46	770 330 104	48
770 294 107	45	770 310 207	46	770 330 105	48
770 294 108	45	770 310 208	46	770 330 106	48
770 294 109	45	770 310 209	46	770 330 107	48
770 294 204	45	770 310 210	46	770 330 108	48
770 294 205	45	770 310 211	46	770 330 109	48
770 294 206	45	770 312 102	47	770 330 110	48
770 294 207	45	770 312 103	47	770 330 111	48
770 294 208	45	770 312 104	47	770 330 112	48
770 294 209	45	770 312 105	47	770 330 202	48
770 300 101	45	770 312 106	47	770 330 203	48
770 300 102	45	770 312 107	47	770 330 204	48
770 300 103	45	770 312 108	47	770 330 205	48
770 300 104	45	770 312 109	47	770 330 206	48
770 300 105	45	770 312 202	47	770 330 207	48
770 300 106	45	770 312 203	47	770 330 208	48
770 300 107	45	770 312 204	47	770 330 209	48
770 300 108	45	770 312 205	47	770 330 210	48
770 300 109	45	770 312 206	47	770 330 211	48
770 300 110	45	770 312 207	47	770 330 212	48
770 300 111	45	770 312 208	47	770 331 102	49
770 300 112	45	770 312 209	47	770 331 103	49
770 300 201	45	770 320 104	47	770 331 104	49
770 300 202	45	770 320 105	47	770 331 105	49
770 300 203	45	770 320 106	47	770 331 106	49
770 300 204	45	770 320 107	47	770 331 107	49
770 300 205	45	770 320 108	47	770 331 108	49
770 300 206	45	770 320 109	47	770 331 109	49

Index

Code	Page	Code	Page	Code	Page
770 331 110	49	770 341 103	51	770 346 205	53
770 331 111	49	770 341 104	51	770 346 206	53
770 331 202	49	770 341 105	51	770 346 207	53
770 331 203	49	770 341 106	51	770 346 208	53
770 331 204	49	770 341 107	51	770 346 209	53
770 331 205	49	770 341 108	51	770 350 104	54
770 331 206	49	770 341 109	51	770 350 105	54
770 331 207	49	770 341 110	51	770 350 106	54
770 331 208	49	770 341 111	51	770 350 204	54
770 331 209	49	770 341 112	51	770 350 205	54
770 331 210	49	770 341 202	51	770 350 206	54
770 331 211	49	770 341 203	51	770 351 104	54
770 332 105	49	770 341 204	51	770 351 105	54
770 332 106	49	770 341 205	51	770 351 106	54
770 332 107	49	770 341 206	51	770 351 204	54
770 332 205	49	770 341 207	51	770 351 205	54
770 332 206	49	770 341 208	51	770 351 206	54
770 332 207	49	770 341 209	51	770 356 104	54
770 335 104	49	770 341 210	51	770 356 105	54
770 335 105	49	770 341 211	51	770 356 106	54
770 335 106	49	770 341 212	51	770 356 204	54
770 335 107	49	770 342 104	52	770 356 205	54
770 335 108	49	770 342 105	52	770 356 206	54
770 335 204	49	770 342 106	52	770 370 105	55
770 335 205	49	770 342 107	52	770 370 106	55
770 335 206	49	770 342 108	52	770 370 107	55
770 335 207	49	770 342 109	52	770 370 108	55
770 335 208	49	770 342 204	52	770 370 109	55
770 336 104	50	770 342 205	52	770 370 110	55
770 336 105	50	770 342 206	52	770 370 111	55
770 336 106	50	770 342 207	52	770 370 119	55
770 336 107	50	770 342 208	52	770 370 120	55
770 336 108	50	770 342 209	52	770 370 205	55
770 336 204	50	770 344 102	53	770 370 206	55
770 336 205	50	770 344 103	53	770 370 207	55
770 336 206	50	770 344 104	53	770 370 208	55
770 336 207	50	770 344 105	53	770 370 209	55
770 336 208	50	770 344 106	53	770 370 210	55
770 338 220	50	770 344 107	53	770 370 211	55
770 338 221	50	770 344 108	53	770 370 219	55
770 338 222	50	770 344 109	53	770 370 220	55
770 340 101	51	770 344 202	53	770 371 104	55
770 340 102	51	770 344 203	53	770 371 105	55
770 340 103	51	770 344 204	53	770 371 106	55
770 340 104	51	770 344 205	53	770 371 107	55
770 340 105	51	770 344 206	53	770 371 108	55
770 340 106	51	770 344 207	53	770 371 109	55
770 340 107	51	770 344 208	53	770 371 110	55
770 340 108	51	770 344 209	53	770 371 111	55
770 340 109	51	770 345 104	52	770 371 115	56
770 340 110	51	770 345 105	52	770 371 204	55
770 340 111	51	770 345 106	52	770 371 205	55
770 340 112	51	770 345 107	52	770 371 206	55
770 340 120	51	770 345 108	52	770 371 207	55
770 340 201	51	770 345 109	52	770 371 208	55
770 340 202	51	770 345 204	52	770 371 209	55
770 340 203	51	770 345 205	52	770 371 210	55
770 340 204	51	770 345 206	52	770 371 211	55
770 340 205	51	770 345 207	52	770 372 104	56
770 340 206	51	770 345 208	52	770 372 105	56
770 340 207	51	770 345 209	52	770 372 106	56
770 340 208	51	770 346 104	53	770 372 107	56
770 340 209	51	770 346 105	53	770 372 108	56
770 340 210	51	770 346 106	53	770 372 109	56
770 340 211	51	770 346 107	53	770 372 110	56
770 340 212	51	770 346 108	53	770 372 111	56
770 340 220	51	770 346 109	53	770 372 115	56
770 341 102	51	770 346 204	53	770 372 116	56

Index

Code	Page
770 372 119	56
770 372 133	56
770 372 204	56
770 372 205	56
770 372 206	56
770 372 207	56
770 372 208	56
770 372 209	56
770 372 210	56
770 372 211	56
770 372 215	56
770 372 216	56
770 372 219	56
770 372 233	56
770 373 105	57
770 373 106	57
770 373 107	57
770 373 205	57
770 373 206	57
770 373 207	57
770 374 105	57
770 374 106	57
770 374 107	57
770 374 108	57
770 374 109	57
770 374 110	57
770 374 111	57
770 374 116	57
770 374 118	57
770 374 119	57
770 374 120	57
770 374 121	57
770 374 135	57
770 374 205	57
770 374 206	57
770 374 207	57
770 374 208	57
770 374 209	57
770 374 210	57
770 374 211	57
770 374 216	57
770 374 218	57
770 374 219	57
770 374 220	57
770 375 104	58
770 375 105	58
770 375 106	58
770 375 204	58
770 375 205	58
770 375 206	58
770 376 105	58
770 376 106	58
770 376 107	58
770 376 108	58
770 376 109	58
770 376 110	58
770 376 125	58
770 376 205	58
770 376 206	58
770 376 207	58
770 376 208	58
770 376 209	58
770 376 210	58
770 376 225	58
770 378 220	58
770 378 221	58
770 378 222	58
770 471 203	62

Code	Page
770 471 204	62
770 471 205	62
770 526 119	62
770 526 120	62
770 526 121	62
770 526 122	62
770 526 123	62
770 526 124	62
770 526 125	62
770 526 126	62
770 526 127	62
770 526 128	62
770 526 129	62
770 526 130	62
770 526 131	62
770 526 132	62
770 526 133	62
770 526 134	62
770 526 135	62
770 526 219	62
770 526 220	62
770 526 221	62
770 526 222	62
770 526 223	62
770 526 224	62
770 526 225	62
770 526 226	62
770 526 227	62
770 526 228	62
770 526 229	62
770 526 230	62
770 526 231	62
770 526 232	62
770 526 233	62
770 526 234	62
770 526 235	62
770 529 102	63
770 529 103	63
770 529 104	63
770 529 105	63
770 529 106	63
770 529 107	63
770 529 108	63
770 529 109	63
770 529 202	63
770 529 203	63
770 529 204	63
770 529 205	63
770 529 206	63
770 529 207	63
770 529 208	63
770 529 209	63
770 534 204	63
770 534 205	63
770 534 206	63
770 535 204	64
770 535 205	64
770 535 206	64
770 536 204	64
770 536 205	64
770 536 206	64
770 536 207	64
770 536 208	64
770 536 209	64
770 537 204	65
770 537 205	65
770 537 206	65
770 537 207	65

Code	Page
770 537 208	65
770 537 209	65
770 595 104	65
770 595 105	65
770 595 106	65
770 595 204	65
770 595 205	65
770 595 206	65
770 596 101	65
770 596 102	65
770 596 103	65
770 596 104	65
770 596 105	65
770 596 106	65
770 596 107	65
770 596 108	65
770 596 109	65
770 596 201	65
770 596 202	65
770 596 203	65
770 596 204	65
770 596 205	65
770 596 206	65
770 596 207	65
770 596 208	65
770 596 209	65
770 599 104	66
770 599 105	66
770 599 106	66
770 599 107	66
770 599 108	66
770 599 109	66
770 599 204	66
770 599 205	66
770 599 206	66
770 599 207	66
770 600 104	20
770 600 105	20
770 600 106	20
770 600 204	20
770 600 205	20
770 600 206	20
770 695 104	18
770 695 105	18
770 695 106	18
770 695 107	18
770 695 108	18
770 695 109	18
770 695 204	18
770 695 205	18
770 695 206	18
770 695 207	18
770 695 208	18
770 695 209	18
770 901 215	66
770 901 217	66
770 901 218	66
770 901 219	66
770 932 205	66
770 932 206	66
770 932 207	66
770 933 205	66
770 933 206	66
770 933 207	66
770 960 180	57
770 970 145	63
770 970 146	63
770 970 147	63

Index

Code	Page
770 970 148	63
770 970 245	63
770 970 246	63
770 970 247	63
770 970 248	63

General terms and conditions of Georg Fischer Fittings GmbH, Traisen

according to 08/2015

1 Scope

1.1 These general conditions of sale apply to all deliveries of Georg Fischer Fittings-GmbH, A-3160 Traisen ("Georg Fischer") to the Buyer.
They shall also apply to all future transactions even if reference is not made explicitly to these general conditions of sale.

1.1 Provisions which deviate from or supplement these conditions of sale, in particular the Buyer's general conditions of purchase or verbal agreements, are not accepted by Georg Fischer, unless this has been confirmed in writing by Georg Fischer. These general conditions of sale even apply if Georg Fischer unconditionally makes the delivery in knowledge of Buyer's conflicting terms and conditions.

1.3 All forms of dispatch which enable proof of transmission in the form of a text, such as e.g. telefax, e-mail, etc. shall be deemed to be on a par with communications in written form.

2 Offers

Georg Fischer's offers are not binding, unless agreed otherwise in writing. An order shall only be deemed accepted by Georg Fischer if confirmed in writing and if the order confirmation was received by Buyer.

3 Scope of Delivery

3.1 Georg Fischer reserves the right to introduce modifications to its range of products.
3.2 The order confirmation shall govern the scope and execution of the contract.
3.3 If the column „SP“ of the current addition of the Sales Catalogue "Program and Index values" shows a specific quantity, such quantity reflects the minimum order quantity.

4 Data and Documentation

4.1 Technical documentation such as drawings, descriptions, illustrations, any indications of measurements, properties or weight and reference to norms shall serve the purpose of providing information only and do not contain any guarantees with respect to properties.
If and when it appears timely in view of technical progress Georg Fischer reserves the right to make appropriate modifications.

4.2 All technical documentation remains the intellectual property of Georg Fischer and may only be used for the purposes agreed upon or for the purposes indicated by Georg Fischer.

5 Confidentiality, Data Protection

5.1 Each party shall treat as confidential all non-public commercial or technical information pertaining to the other party of which it gains knowledge in the course of its business relationship with the other party. Such information shall neither be disclosed to third parties nor used for other purposes than those for which the information has been supplied.
5.2 Within the context of the contractual relationship with the Buyer the processing of personal data may be required. The Buyer hereby grants his approval in this respect and accepts that Georg Fischer may also disclose such data to third parties (e.g. sub-contractors) in Austria and abroad for the purpose of handling and maintaining business relations.

6 Regulations at the Place of Destination, Export Controls

6.1 The Buyer must draw the attention of Georg Fischer to local provisions of law or other regulations which refer to the execution of delivery and compliance with safety regulations and approval procedures.

6.2 In case of re-exports, the Buyer shall be responsible for compliance with pertinent export control regulations.

7 Price

7.1 Unless agreed otherwise, the prices shall be deemed quoted ex works according to Incoterms 2010 of the ICC (or latest edition), incl. standard packaging. All additional charges such as costs for freight, insurance, export, transit, import or other permits as well as legalisations ("Ancillary Costs") shall be borne by the Buyer. Likewise the Buyer shall bear the costs of all taxes, levies, charges and customs duties.

7.2 Upon request Buyer shall be provided with the Ancillary Costs accruing for the respective products, with the order confirmation at the latest.

8 Terms of Payment

8.1 Payments are to be made by the Buyer at the place in which the Georg Fischer company that issues the invoice is located without any deductions such as cash discount, expenses, taxes and fees, in accordance with terms of payment agreed upon. Invoices are payable within 14 days net, unless otherwise agreed.

8.2 The Buyer shall only have a right of set-off and a right of retention with respect to claims which are either undisputed or have been established as being binding in law. In particular payments are also to be made if unessential parts of the delivery are still outstanding, provided that the use of the delivery is not rendered impossible as a result.

9 Reservation of Title

9.1 The delivered products shall remain the property of Georg Fischer until the Buyer has settled all claims which accrue to Georg Fischer against the Buyer at the time of the delivery.

9.2 Should the Buyer in the ordinary course of business resell any products to which title is reserved, the Buyer hereby internally assigns to Georg Fischer those rights which accrue to the Buyer against his customers arising out of the sale of products including all collateral rights, securities and reservations of title until Buyer has paid all of Georg Fischer's receivables, irrespective of whether the products were resold without or after processing. If the Buyer is in default with his payment obligations, he has to inform Georg Fischer about the assignment of claims and the applicable debtors, to provide all information necessary to collect the debt, hand over the relevant documentation and notify the debtors of the assignment. Until revoked by Georg Fischer, this assignment shall not preclude the Buyer's right to collect the assigned receivables.

9.3 If the value of the goods subject to the above-mentioned retention of title - together with collateral securities provided to Georg Fischer - exceeds Georg Fischer's claims against the Buyer by more than 20%, Georg Fischer shall re-assign the rights mentioned under Section 9.2 to the Buyer at his request.

9.4 With the processing, combination and mixing of the products with other goods Georg Fischer acquires the co-ownership in the new good in proportion of the value of the Georg Fischer products in which title is reserved (final invoice amount incl. VAT) to the other processed, combined or mixed goods.

9.5 Should Buyer be in breach of contract, in particular payment default, Georg Fischer shall be entitled to take back the goods in which title is reserved after having issued a reminder and the Buyer is obliged to surrender such products.

10 Delivery

10.1 Delivery dates indicated by Georg Fischer are not binding, unless explicitly stated otherwise in the order confirmation explicitly. Any binding term of delivery begins as soon as the contract has been entered into, all official formalities such as permits for import and payment have been obtained and all essential technical issues have been settled. It shall be considered as met when the delivery is ready for dispatch.

10.2 The obligation to deliver is subject to the following conditions, i.e. the term of delivery will be extended or the delivery date will be postponed by a reasonable period of time:

- if Georg Fischer does not receive in time the information necessary for the execution of the order or if subsequent changes causing delays are made by the Buyer;
- if Georg Fischer is prevented from performing the delivery by an occurrence of force majeure. Force majeure shall equally be deemed to consist of unforeseeable circumstances for which Georg Fischer is not to be held responsible which make it unreasonably difficult or impossible for Georg Fischer to make the delivery, such as delays in deliveries or defective deliveries from the designated suppliers, industrial action, official measures, a shortage of raw materials or energy, significant disruptions of operations, for example by destruction of the plant as a whole or of important departments or as a result of the breakdown of essential facilities, serious transport hold-ups, e.g. as a result of road blockades. If these circumstances prevail for over six (6) months, both parties shall have the right to withdraw from the contract. The Buyer shall not be entitled to claim compensation for damages;
- if the Buyer is in default in performance of its contractual obligations, in particular if it does not comply with the terms of payment or does not provide the securities agreed upon in a timely manner.

10.3 If Georg Fischer is to be held responsible for exceeding the agreed term of delivery (including a reasonable extension thereof), Georg Fischer shall not be deemed in default until the Buyer has granted to Georg Fischer in writing a reasonable extension thereof of not less than one (1) month which equally is not met. Thereafter the Buyer shall be entitled to the remedies provided by law. Subject to limitations of Section 16, any claim the Buyer may have to compensation for damages for delay shall, however, be limited to a maximum of 10% of the price of the delayed delivery.

10.4 Partial deliveries shall be allowed. Georg Fischer may issue partial invoices for partial deliveries.

10.5 If the Buyer does not take in time delivery of goods which have been notified as been ready for dispatch, Georg Fischer shall be entitled to store the goods at the expense and at the risk of the Buyer and to invoice the goods as having been delivered. If the Buyer fails to effect payment, Georg Fischer shall in particular be entitled to dispose otherwise of the goods.

10.6 In the event that the Buyer cancels an order and Georg Fischer does not insist on performance of the contract, Georg Fischer shall be entitled to a penalty amounting to 10% of the contract price (forfeited penalty), as well as to damages in excess of this amount for which proof is submitted. The Buyer shall be entitled to provide evidence that Georg Fischer actually has suffered no damage or that its damage is considerably lower than the penalty forfeited.

11 Packaging

If the products are packaged in a way which is above and beyond the standard packaging, the extra packaging in question will be charged additionally.

12 Passing of Risk

12.1 The risk passes to the Buyer as soon as they have left Georg Fischer's works (EX WORKS, Incoterms 2010 ICC, or latest version), even if delivery is at Georg Fischer's expense, under similar clauses or including installation or when carriage is organised and managed by Georg Fischer.

12.2 If delivery is delayed for reasons for which Georg Fischer is not to be held responsible, the risk shall pass to the Buyer upon notification that the goods are ready for dispatch.

13 Shipment and Insurance

13.1 Unless agreed otherwise, the Buyer shall bear the cost of carriage.

13.2 Insurance against damages of any kind whatsoever shall be the Buyer's responsibility. Even when insurance is arranged by Georg Fischer, it shall be deemed to have been taken out by order and for the account of the Buyer.

13.3 Any special requests regarding carriage and insurance shall be communicated to Georg Fischer in due time. Otherwise carriage shall be arranged by Georg Fischer at Georg Fischer's discretion - without, however, assuming responsibility - by the fastest and most cost-efficient method possible.

If it is individually agreed, that Georg Fischer bears the shipping costs, transport arrangements shall be made by Georg Fischer. If the Buyer issues special instructions in this connection, any additional costs will be charged to the Buyer.

13.4 In the event of damage to or loss of products during carriage, the Buyer shall mark the delivery documents accordingly and immediately have the damage ascertained by the carrier. Not readily ascertainable damages incurred during carriage shall be notified to the carrier within six (6) workdays after receipt of the products.

14 Inspection and Acceptance of Delivery

14.1 The products are tested by Georg Fischer during manufacture to the usual extent. If the Buyer wishes more extensive testing, such tests must be agreed upon in writing and are to be paid by the Buyer.

14.2 The Buyer undertakes to comply with its statutory obligations of inspection and notice obligations. Defects in respect of weight, number of items or the external appearance and workmanship of the products must be reported by the latest five (5) workdays after receipt thereof. The Buyer must give written notice of other defects immediately after discovery, in any case, however, within the agreed period of warranty. Notice of defects must be made in writing.

14.3 Defective parts must in any case be kept until claims under warranty or claims to compensation for damage have been finally clarified and must be made available to Georg Fischer upon request.

14.4 If so requested, Georg Fischer is to be given the opportunity to appraise the defect and/or the damage - either by itself or by third party experts - prior to commencement of repair work.

15 Liability for Defects

15.1 Upon receipt of a written request of the Buyer, Georg Fischer undertakes (at its own choice) to repair or replace as soon as possible and free of charge all products which it can be proven have become defective or unusable due to poor materials, faulty design, faulty workmanship, faulty operating or installation instructions.

In order to protect employees from toxic or radioactive substances which may have been transported through defective parts returned to Georg Fischer's sales organisation, said parts must be accompanied by a Material Safety Disclosure Form. The form may be obtained from Georg Fischer's local sales company or via www.piping.georgfischer.com. Parts which are replaced become the property of Georg Fischer, unless Georg Fischer waives such claim.

15.2 For products which are manufactured according to the Buyer's specifications, drawings or models, Georg Fischer's warranty is limited to proper materials and workmanship.

15.3 The Buyer is entitled to require rescission of the contract or a reduction of the contract price, if - it is impossible to carry out a repair or make a subsequent delivery;
- Georg Fischer does not succeed in carrying out the repair or making a subsequent delivery within a reasonable period of time or
- Georg Fischer refuses to carry out the repair or make a subsequent delivery or is negligent in causing a delay in this respect.

15.4 For products or essential components manufactured by third party, Georg Fischer's warranty is limited to the warranty provided by said third party.

15.5 The warranty shall not apply to defects and damage in cases of insignificant deviations from the agreed quality or resulting from natural wear and tear, inadequate storage or maintenance, non-compliance with operating and assembly instructions, overloading, unsuitable operational supplements, defective construction work, unsuitable building ground, inappropriate repairs or alterations by the Buyer or third parties, use of non-original spare parts and other reasons for which Georg Fischer is not to be held responsible.

15.6 Claims based on warranty or liability shall become time-barred twelve (12) months after receipt of the delivery by the end user, at the latest, however, eighteen (18) months after dispatch of the delivery by Georg Fischer.

15.7 For Products that are customarily used for a building and caused such building's defectiveness for products, which find application in underground pipeline construction,
a) Georg Fischer assumes in connection with the subsequent performance the proportionate dismantling and assembly costs for the restoration of the original state of the affected object as well as - in cases of negligence - all other direct damages (personal injury and property damage). Section 16, however, applies accordingly, and
b) in deviation of Section 15.6 warranty and liability claims, expire five (5) years after installation, but not later than seven (7) years after the manufacturing date.

Thereby, Georg Fischer assumes the costs of dismantling and assembly costs for the restoration of the original state of the affected object up to a maximum of € 730,000 per occurrence; this liability shall, moreover, be limited to an overall maximum of € 2,000,000 in the case of serial losses. This limitation shall not apply in cases of intent or blatant gross negligence on the part of Georg Fischer.

16 Limitation of Liability

Only in instances of intent and blatant gross negligence shall Georg Fischer (including his officers, his employees and other vicarious agents) be liable for breach of contractual and extra-contractual obligations, in particular due to frustration, delay, demonstrable false advice, pre-contractual liability. This disclaimer applies in particular to the liability of indirect and consequential damages, such as loss of production, loss of orders, claims for compensation by third parties and loss of profits.

Insofar Georg Fischer's liability thereby exists it is limited to foreseeable, typically occurring damage.

If one Party claims a breach of contract by the other party, it must take all necessary measures to mitigate the damage caused thereby, provided that this can be done with economically reasonable means.

If the party concerned does not comply with its duty to mitigate damages, the other party may demand adequate reduction of its obligation to pay damages.

This limitation of liability does not apply to any culpable infringement of essential contractual obligations, the lack of assured properties as well as in cases of compulsory liability according to the product liability law applicable to the respective product delivered.

17 Severability

Should certain provisions in these general conditions of sale in whole or in part be or become invalid or null and void, the contracting parties undertake to replace the invalid or null and void provision with a valid provision which comes as close as possible to fulfilling the meaning and purpose of the invalid or null and void provision.

18 Place of Performance and Place of Jurisdiction

18.1 Place of performance for the products shall be the Georg Fischer works from which the products are despatched.

18.2 If any disputes arise out of the contractual relationship, the lawsuit is to be filed exclusively with the competent court in St. Pölten, Austria. Georg Fischer is, however, also entitled to bring an action before any other competent court.

18.3 The contractual relationship is subject to Austrian law (excluding the choice of law principles thereof and the United Nations Convention on Contracts for the International Sale of Goods) in accordance with the Austrian Code of Civil Law (ABGB) and the Austrian Code of Commercial Law (HGB).

We support you

Our sales companies and representatives ensure local customer support in the following countries.

www.gfps.com
www.fittings.at



Production / Sales in Austria

Georg Fischer Fittings GmbH
Mariazeller Strasse 75
A-3160 Traisen
Tel. +43(0)2762 90300-371
Fax +43(0)2762/90300-432
fittings.ps@georgfischer.com
www.fittings.at

Belgium/Luxembourg

Georg Fischer NV/SA
Vaartdijk 109-111 Digue du Canal
B-1070 Bruxelles/Brüssel
Tel. +32(0)2/556 40 20
Fax +32(0)2/524 34 26
be.ps@georgfischer.com
www.gfps.com/be

Denmark

Georg Fischer A/S
Malervej 4DK-2630 Taastrup
Tel. +45(0)70 22 19-75
Fax +45(0)70 22 19-76
info.dk.ps@georgfischer.com
www.gfps.com/dk

France

Georg Fischer SAS
Bâtiment Le Rabelais
Paris Nord 2
22 Avenue des Nations
BP 88026 Villepinte
F-95932 Roissy Charles
de Gaulle Cedex
Tel. +33(0)1/41 84 68 84
Fax +33(0)1/41 84 68 85
fr.ps@georgfischer.com
www.gfps.com/fr

Germany

Georg Fischer GmbH
Daimlerstrasse 6
D-73095 Albershausen
Tel. +49(0)7161/302-0
Fax +49(0)7161/302-259
info.de.ps@georgfischer.com
www.gfps.com/de

Italy

Georg Fischer S.p.A.
Via Sondrio 1
I-20063 Cernusco S/N (MI)
Tel. +39(0)2/921 861
Fax +39(0)2/921 862 47
it.ps@georgfischer.com
www.gfps.com/it

Netherlands

Georg Fischer N.V.
Lange Veenteweg 19
NL-8161 PA Epe
Tel. +31(0)578/678 222
Fax +31(0)578/621 768
nl.ps@georgfischer.com
www.gfps.com/nl

Norway

Georg Fischer AS
Rudsletta 97
N-1351 Rud
Tel. +47(0)67 18 29 00
Fax +47(0)67 13 92 92
no.ps@georgfischer.com
www.gfps.com/no

Spain

Georg Fischer S.A.
Paseo de la Castellana 184
7ª Planta
E-28046 Madrid
Tel. +34(0)91/781 98 90
Fax +34(0)91/426 08 23
es.ps@georgfischer.com
www.gfps.com/es

Sweden

Georg Fischer AB
Lijeholmsstranden 5
SE-11743 Stockholm
Tel. +46(0)8 506 775 00
Fax +46(0)8 749 237 0
info.se.ps@georgfischer.com
www.gfps.com/se

Switzerland

Georg Fischer
Rohrleitungssysteme (Schweiz) AG
Ebnatstrasse 101
CH-8201 Schaffhausen
Tel. +41(0)52 631 30 26
Fax +41(0)52 631 28 96
ch.ps@georgfischer.com
www.gfps.com/ch

United Kingdom

George Fischer Sales Limited
Paradise Way
Coventry, CV2 2ST
Tel. +44(0)2476 535 535
Fax +44(0)2476 530 450
uk.ps@georgfischer.com
www.gfps.com/uk

The technical data are not binding and not expressly warranted characteristics of the goods. They are subject to change. Our General Conditions of Sale apply.